

General Description

NJRC delivers ICs in 4 methods, plastic tube container, two kinds of Taping, tray and vinyl bag packing. Except adhesive tape treated anti electrostatic and contain carbon are using as the ESD (Electrostatic Discharge Damage) protection.

TO-252 Emboss Taping (TE1/TE2)

Symbol	TO-252-3-L1	TO-252-5-L3	Remark
A	6.9±0.1		Bottom size
B	10.5±0.1		Bottom size
D ₀	1.5+0.1/-0		
D ₁	1.5+0.1/-0		
E	1.75±0.1		
F	7.5±0.1		
P ₀	4.0±0.1		
P ₁	8.0±0.1		
P ₂	2.0±0.1		
T	0.3±0.1		
T ₂	3.1 MAX		
W	16.0±0.3		
W ₁	13.5		Thickness 0.1MAX

Unit : mm

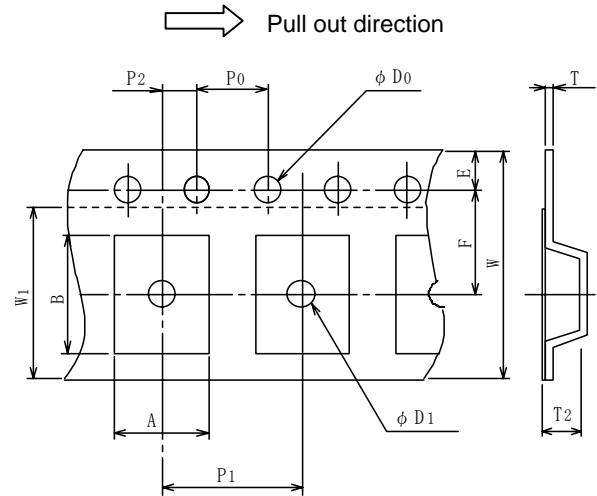

Symbol	TO-252-3-L1	TO-252-5-L3
A	Ø330±2	
B	Ø80±1	
C	Ø13±0.5	
E	2	
W	17.5±0.5	
W ₁	2±0.5	
Contents	3,000 pcs	

Unit : mm

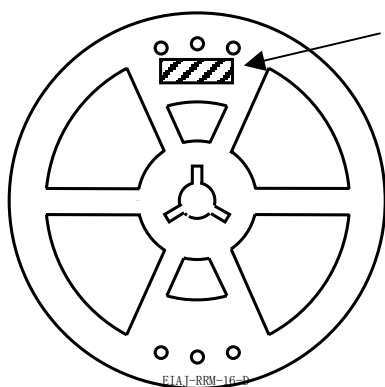
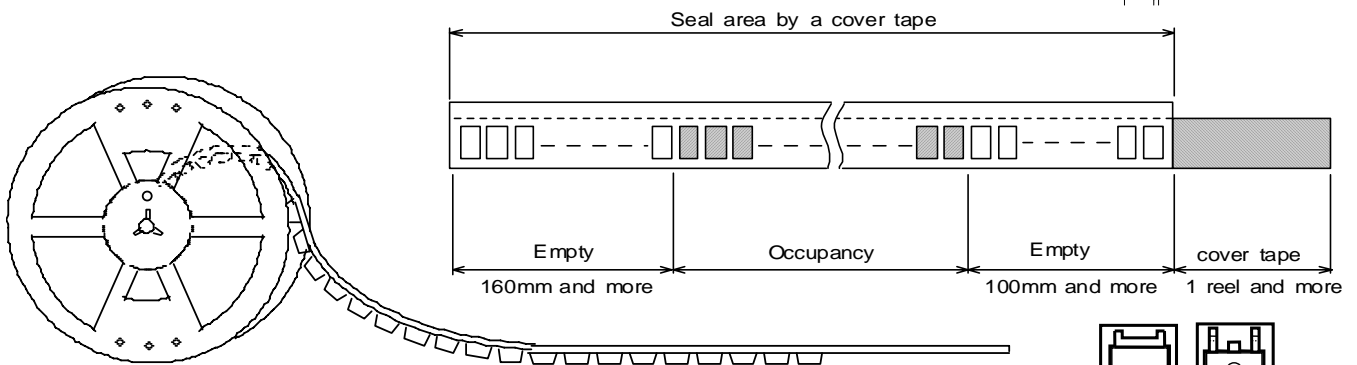
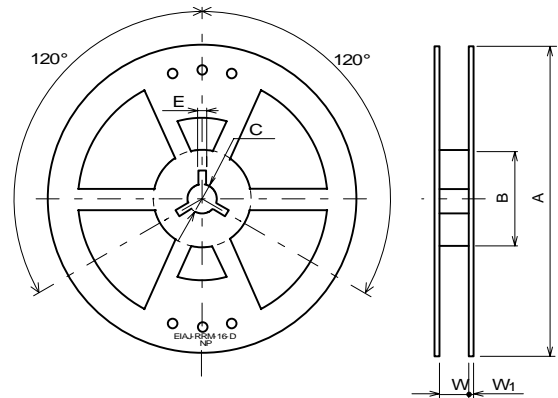

Label

Put in the outer box

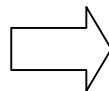

Pull out direction

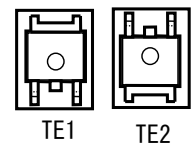

TE1

TE2

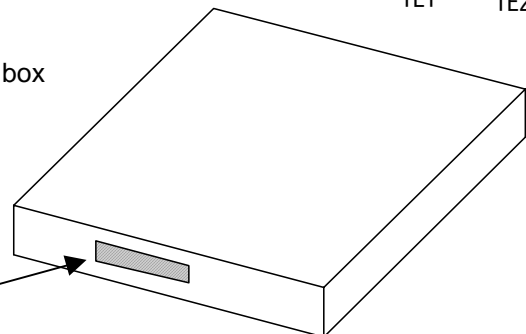

Label