

General Description

NJRC delivers ICs in 4 methods, plastic tube container, two kinds of Taping, tray and vinyl bag packing. Except adhesive tape treated anti electrostatic and contain carbon are using as the ESD (Electrostatic Discharge Damage) protection.

SOP8 JEDEC 150 mil (G type) Emboss Taping (TE2)

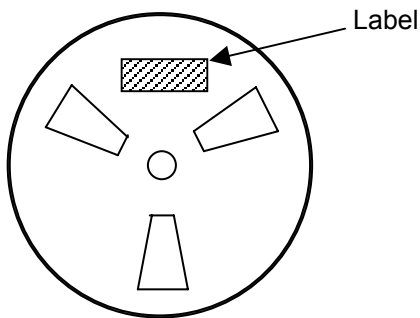
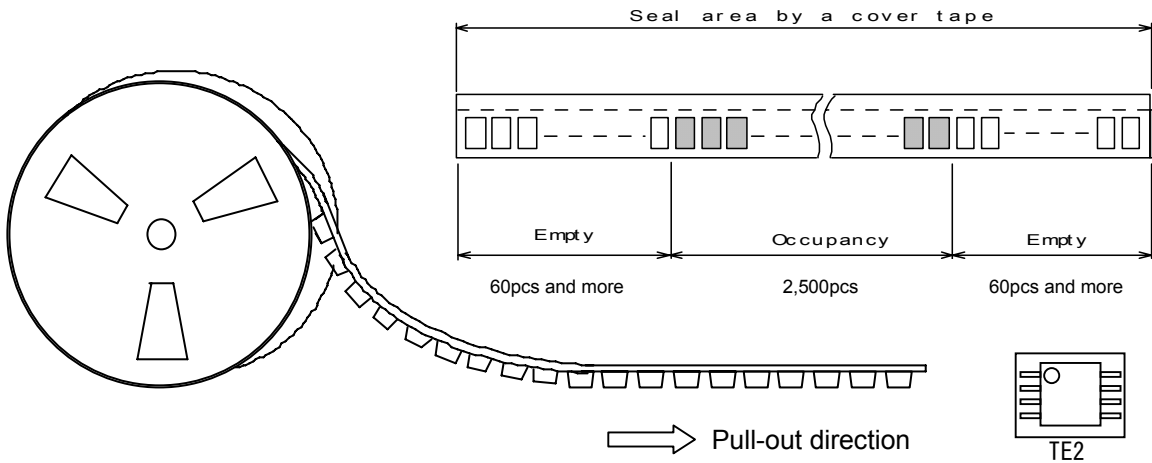
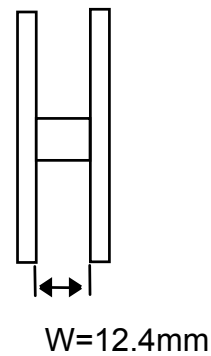
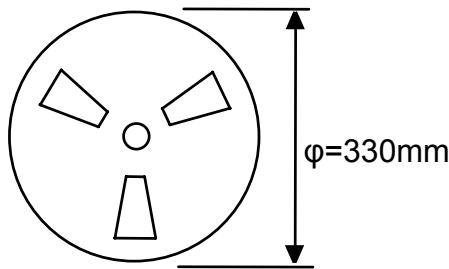
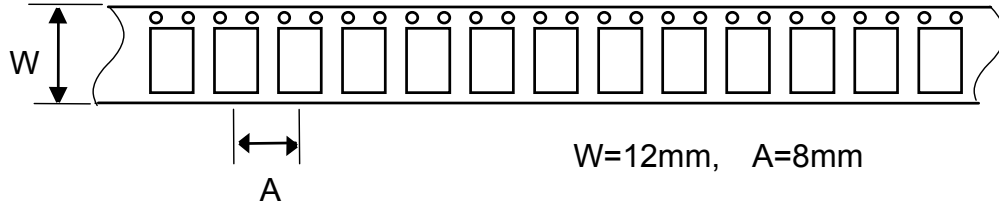

Put in the outer box

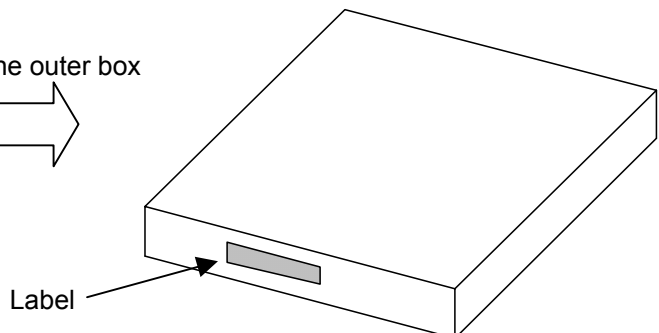
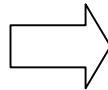

PACKING SPECIFICATION

SOP14 JEDEC 150 mil (G type) Emboss Taping (TE2)

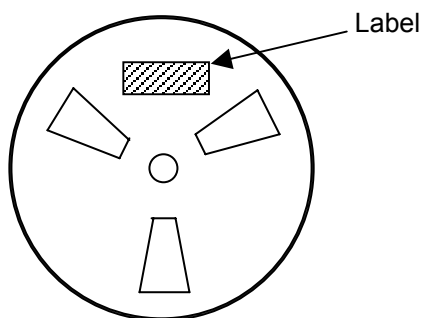
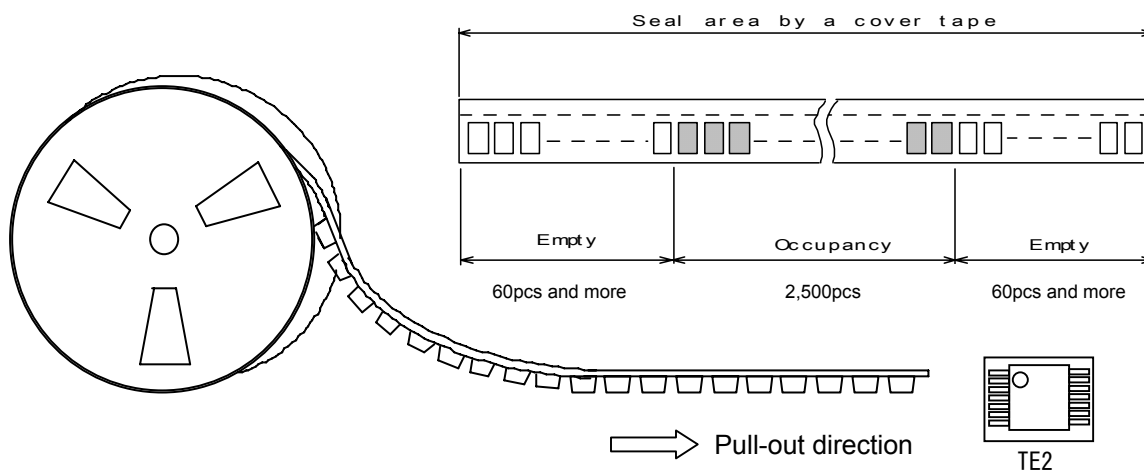
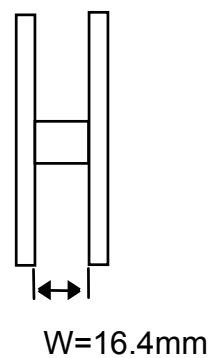
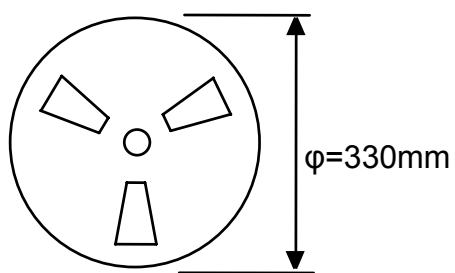
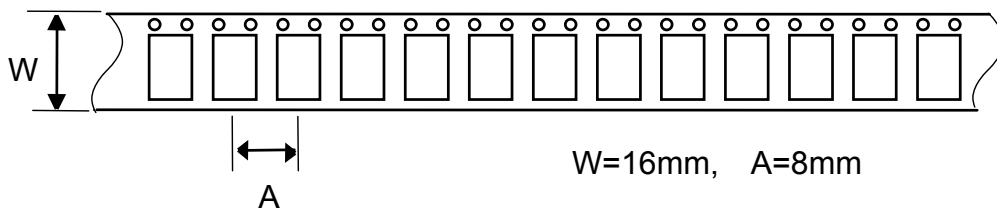

Put in the outer box

