

Designated client product

This product will be discontinued its production in the near term.
And it is provided for customers currently in use only, with a time limit.
It can not be available for your new project. Please select other new or existing products.

For more information, please contact our sales office in your region.

New Japan Radio Co.,Ltd.

<http://www.njr.com/>

High Output Current, Rail-to-Rail Input/Output Single CMOS Operational Amplifier with Shutdown

■ GENERAL DESCRIPTION

The NJU7045 is a Rail-to-Rail Input/Output single CMOS operational amplifier with a low operating voltage from 2.2V to 5.5V and shutdown function which offers low power operation.

It offers a high output current of 40mA (at $V_{DD}=3V$) which is higher than our conventional CMOS operational amplifiers, low operating current of 350 μ A (typ. active) and 0.9 μ A (typ. at shutdown), low voltage operation, low input bias current of 1pA and ground sensing, which is suitable for various applications. The NJU7045 is available in 8-lead small surface mount packages of SOP8 JEDEC 150mil, MSOP8 (TVSP8) and a 6-lead tiny package of SOT-23-6.

■ PACKAGE OUTLINE

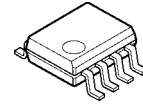

NJU7045E
(SOP8)

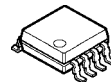

NJU7045RB1
(MSOP8(TVSP8))



NJU7045F1
(SOT-23-6)

■ FEATURES

- Operating Voltage: 2.2V to 5.5V
- Rail-to-Rail Input/Output
- High Output Current: 40mA at $V_O=0V$
- Input Offset Voltage: $V_{IO}=10mV$ max.
- Wide Input Common Mode: Voltage Range: V_{SS} to V_{DD}
- Operating Current: (Active) $I_{DD}=350\mu A$ typ. (at $V_{DD}=3V$)
(Shutdown) $I_{DD}=0.9\mu A$ typ. (at $V_{DD}=2.2V$ to 5.5V)
- High Input Impedance: 1T Ω Typ.
- Low Input Bias Current: $I_{IB}=1pA$ typ.
- Ground Sensing
- Tiny Package: SOP8 JEDEC 150mil
MSOP8 (TVSP8) MEET JEDEC MO-187-DA/ THIN TYPE
SOT-23-6

■ PIN CONFIGURATION

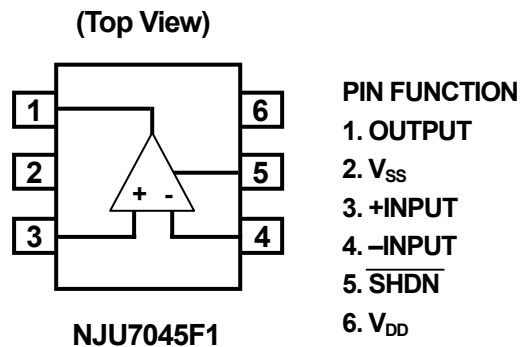
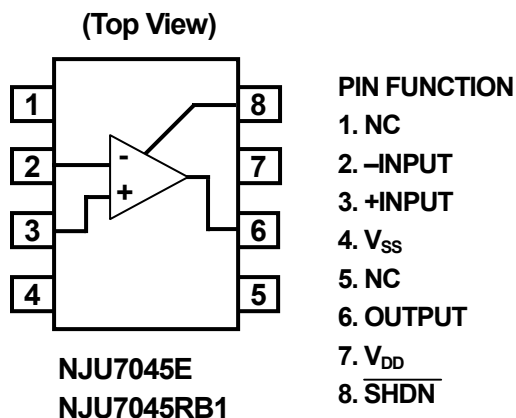

■ ABSOLUTE MAXIMUM RATINGS

PARAMETER	SYMBOL	RATINGS	UNIT
Supply Voltage	V_{DD}	7	V
Common Mode Input Voltage Range	V_{ICM}	0 to 7 (Note 1)	V
Differential Input Voltage Range	V_{ID}	± 7	V
Power Dissipation	P_D	300 [SOP8] 500 [SOP8] (Note 2) 700 [SOP8] (Note 3) 320 [MSOP8(TVSP8)] 410 [MSOP8(TVSP8)] (Note 2) 540 [MSOP8(TVSP8)] (Note 3) 200 [SOT-23-6] 410 [SOT-23-6] (Note 2) 580 [SOT-23-6] (Note 3)	mW
Output Current	I_O	± 75 [TVSP8, SOT-23-6]	mA
Operating Temperature Range	T_{opr}	-40 to +85	$^{\circ}C$
Storage Temperature Range	T_{stg}	-55 to +125	$^{\circ}C$

(Note 1) For supply voltage less than 7V, the absolute maximum input voltage is equal to the supply voltage.

(Note 2) On the PCB " EIA/JEDEC (76.2x 114.3x 1.6mm, two layers, FR-4) "

(Note 3) On the PCB " EIA/JEDEC (76.2x 114.3x 1.6mm, four layers, FR-4) "

FIGURE 1. Power Dissipation vs. Ambient Temperature

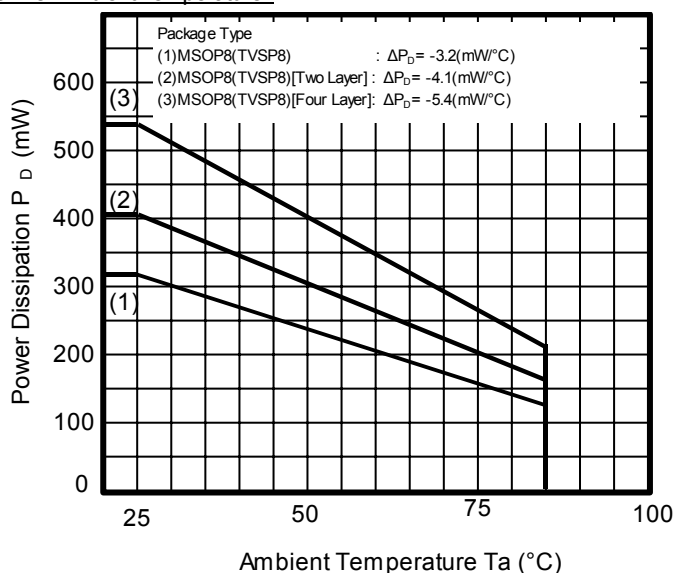
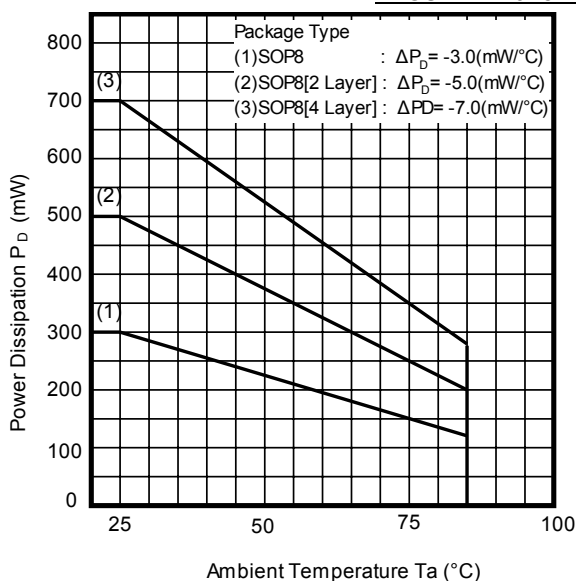
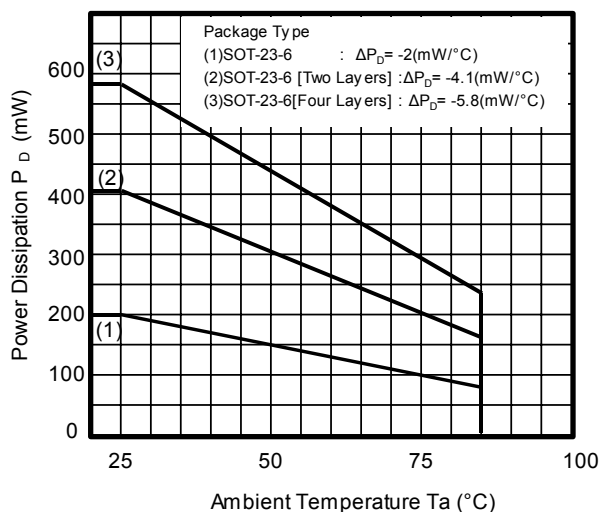

FIGURE 1-2. Power Dissipation vs. Ambient Temperature

(Note 4)

Please do not exceed "Power Dissipation (PD)" the power dissipation in IC is absolutely indicated to be in the maximum rating.

See the figure "Power Dissipation vs. Ambient Temperature" for information on temperature derating of this device.



■ OPERATING VOLTAGE (Ta=25°C)

PARAMETER	SYMBOL	RATINGS	UNIT
Supply Voltage	V _{DD}	2.2 to 5.5	V

■ STATE DEFINITION OF NJU7045 OPERATION

● "State of NJU7045 Operation" vs. "Turn-on/off Control Voltage V_{SD}" (2.2V ≤ V_{DD} ≤ 5.5V, Ta=25°C)

State Definition	CONTROL CONDITION	State of NU7045 Operation
Amplifier Operating	V _{SD} =V _{IH}	Amplifier is active.
Shutdown	V _{SD} =V _{IL}	The output impedance is high, output signal is muted and the supply current is reduced.

■ ELECTRICAL CHARACTERISTICS [Enable/Shutdown Control Information]

● Turn-on/off Control Voltage Range for SHDN Pin (2.2V ≤ V_{DD} ≤ 5.5V, Ta=25°C)

PARAMETER	SYMBOL	TEST CONDITION	MIN.	TYP.	MAX.	UNIT
Turn-on Voltage to Enable part	V _{IH}	(Note 5)	V _{DD} × 0.7	-	V _{DD}	V
Turn-off Voltage	V _{IL}	(Note 5)	0	-	V _{DD} × 0.3	V

(Note 5) The SHDN pin can't be left unconnected.

● DC CHARACTERISTICS of "SHDN Pin" (2.2V ≤ V_{DD} ≤ 5.5V, Ta=25°C)

PARAMETER	SYMBOL	TEST CONDITION	MIN.	TYP.	MAX.	UNIT
Input Bias Current of SHDN Pin	I _{BSD}	0 ≤ V _{SD} ≤ V _{DD}	-	-	±2	μA

● Turn-on/off Time (2.2V ≤ V_{DD} ≤ 5.5V, Ta=25°C)

PARAMETER	SYMBOL	TEST CONDITION	MIN.	TYP.	MAX.	UNIT
Amplifier Turn-off Time	T _{OFF}	T _{VSDHL} ≤ 100ns FIGURE 2,3	-	1	-	μs
Amplifier Turn-on Time	T _{ON}	T _{VSDLH} ≤ 100ns FIGURE 2,3	-	10	-	μs

FIGURE 2. T_{OFF}/T_{ON} CONDITION

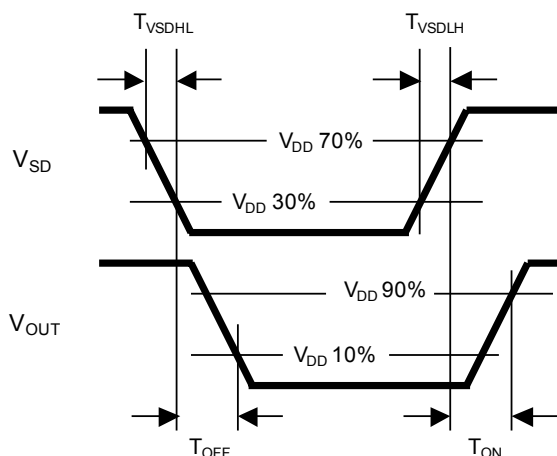
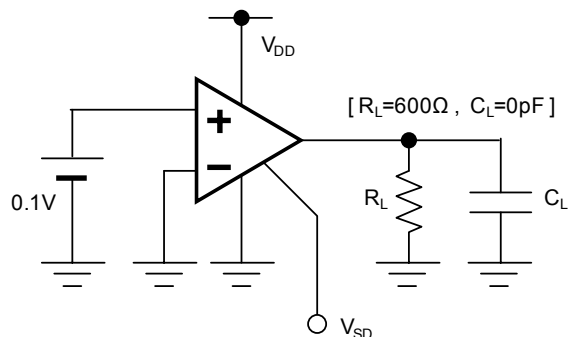

FIGURE 3. T_{OFF}/T_{ON} TEST CIRCUIT



NJU7045

■ELECTRICAL CHARACTERISTICS [Shutdown Characteristics]

●DC CHARACTERISTICS

(2.2V ≤ V_{DD} ≤ 5.5V, Ta=25°C)

PARAMETER	SYMBOL	TEST CONDITION	MIN.	TYP.	MAX.	UNIT
Output Leak Current	I _{LEAK}	FIGURE 4	-	-	±3	μA
Operating Current	I _{DDSD}	No Signal Apply, No Load, V _{SD} ≤ 0.2V	-	-	0.9	μA

●AC CHARACTERISTICS

(2.2V ≤ V_{DD} ≤ 5.5V, Ta=25°C)

PARAMETER	SYMBOL	TEST CONDITION	MIN.	TYP.	MAX.	UNIT
Mute Level	MUTE	V _{IN} =1V _{PP} , f=1kHz, FIGURE 5	-	-100	-	dB

FIGURE 4. LEAK CURRENT TEST CIRCUIT

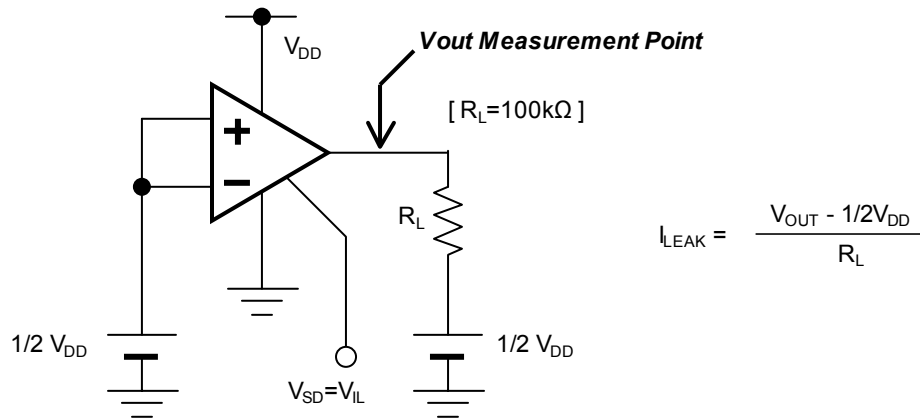
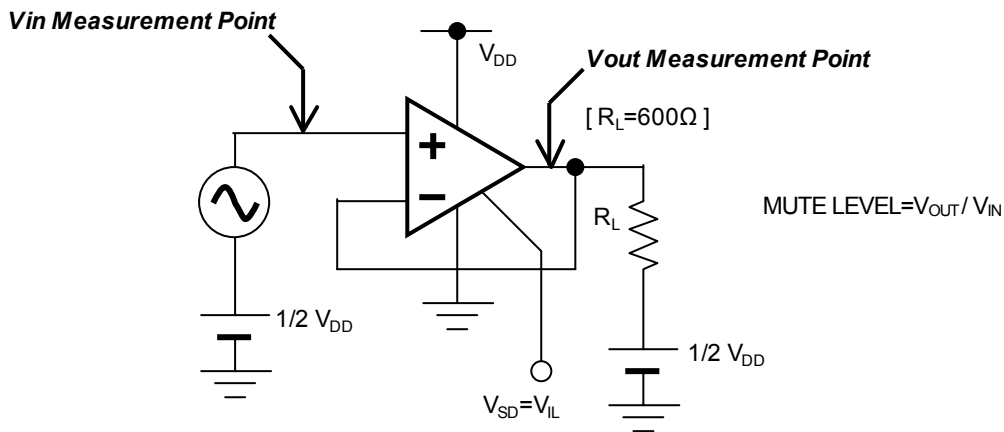

FIGURE 5. MUTE LEVEL TEST CIRCUIT



■ELECTRICAL CHARACTERISTICS [Amplifier Operating]

●DC CHARACTERISTICS

($V_{DD}=5V, 3.5V \leq V_{SD} \leq 5V, T_a=25^\circ C$)

PARAMETER	SYMBOL	TEST CONDITION	MIN.	TYP.	MAX.	UNIT
Operating Current	I_{DD}	No signal Apply, $V_{SD}=V_{DD}$	-	450	700	μA
Input Offset Voltage	V_{IO}		-	-	10	mV
Input Bias Current	I_B		-	1	-	pA
Input Offset Current	I_{IO}		-	1	-	pA
Large Signal Voltage Gain	A_V	$R_L=10k\Omega$ to 2.5V, $V_o=2.5V \pm 2.4V$	70	90	-	dB
Common Mode Rejection Ratio	CMR	CMR+: $2.5V \leq V_{CM} \leq 5V$ CMR-: $0V \leq V_{CM} \leq 2.5V$ (Note 6)	44	60	-	dB
Supply Voltage Rejection Ratio	SVR	$4.0V \leq V_{DD} \leq 5.5V$, $V_{CM}=V_{DD}/2, V_{SD}=V_{DD}$	55	85	-	dB
Output Voltage1	V_{OH1} V_{OL1}	$R_L=10k\Omega$ to 2.5V	4.95	-	-	V
Output Voltage2	V_{OH2} V_{OL2}	$R_L=600\Omega$ to 2.5V	4.9	-	-	V
Output Source Current	I_{SOURCE}	$V_o=2.5V$	70	-	-	mA
Output Sink Current	I_{SINK}	$V_o=2.5V$	70	-	-	mA
Input Common Mode Voltage Range	V_{ICM}	CMR ≥ 44 dB	0	-	5	V

(Note 6) CMR is represented by either CMR+ or CMR- has lower value.

●AC CHARACTERISTICS

($V_{DD}=5V, 3.5V \leq V_{SD} \leq 5V, T_a=25^\circ C$)

PARAMETER	SYMBOL	TEST CONDITION	MIN.	TYP.	MAX.	UNIT
Unity Gain Bandwidth	GB	$R_L=10k\Omega$ to 2.5V	-	0.8	-	MHz
Total Harmonic Distortion	THD	$f=1kHz, V_{IN}=1V_{pp}, A_V=0dB$	-	0.05	-	%
Equivalent Input Noise Voltage	V_{NI}	$f=1kHz$	-	40	-	nV/ \sqrt{Hz}

●TRANSIENT CHARACTERISTICS

($V_{DD}=5V, 3.5V \leq V_{SD} \leq 5V, T_a=25^\circ C$)

PARAMETER	SYMBOL	TEST CONDITION	MIN.	TYP.	MAX.	UNIT
Slew Rate	SR	$R_L=10k\Omega$ to 2.5V	-	0.8	-	V/ μs

■ELECTRICAL CHARACTERISTICS [Amplifier Operating]

●DC CHARACTERISTICS

($V_{DD}=3V, 2.1V \leq V_{SD} \leq 3V, T_a=25^\circ C$)

PARAMETER	SYMBOL	TEST CONDITION	MIN.	TYP.	MAX.	UNIT
Operating Current	I_{DD}	No signal Apply, $V_{SD}=V_{DD}$	-	350	600	μA
Input Offset Voltage	V_{IO}		-	-	10	mV
Input Bias Current	I_B		-	1	-	pA
Input Offset Current	I_{IO}		-	1	-	pA
Large Signal Voltage Gain	A_V	$R_L=10k\Omega$ to 1.5V, $V_O=1.5V \pm 1.4V$	70	90	-	dB
Common Mode Rejection Ratio	CMR	CMR+: $1.5V \leq V_{CM} \leq 3V$ CMR-: $0V \leq V_{CM} \leq 1.5V$ (Note 7)	42	60	-	dB
Supply Voltage Rejection Ratio	SVR	$2.7V \leq V_{DD} \leq 4.0V$, $V_{CM}=V_{DD}/2, V_{SD}=V_{DD}$	50	80	-	dB
Output Voltage1	V_{OH1}	$R_L=10k\Omega$ to 1.5V	2.95	-	-	V
	V_{OL1}	$R_L=10k\Omega$ to 1.5V	-	-	0.05	V
Output Voltage2	V_{OH2}	$R_L=600\Omega$ to 1.5V	2.9	-	-	V
	V_{OL2}	$R_L=600\Omega$ to 1.5V	-	-	0.10	V
Output Source Current	I_{SOURCE}	$V_O=1.5V$	30	40	-	mA
Output Sink Current	I_{SINK}	$V_O=1.5V$	30	40	-	mA
Input Common Mode Voltage Range	V_{ICM}	CMR ≥ 42 dB	0	-	3	V

(Note 6) CMR is represented by either CMR+ or CMR- has lower value.

●AC CHARACTERISTICS

($V_{DD}=3V, 2.1V \leq V_{SD} \leq 3V, T_a=25^\circ C$)

PARAMETER	SYMBOL	TEST CONDITION	MIN.	TYP.	MAX.	UNIT
Unity Gain Bandwidth	GB	$R_L=10k\Omega$ to 1.5V	-	0.8	-	MHz
Total Harmonic Distortion	THD	$f=1kHz, V_{IN}=1V_{pp}, A_V=0dB$	-	0.05	-	%
Equivalent Input Noise Voltage	V_{NI}	$f=1kHz$	-	40	-	nV/\sqrt{Hz}

●TRANSIENT CHARACTERISTICS

($V_{DD}=3V, 2.1V \leq V_{SD} \leq 3V, T_a=25^\circ C$)

PARAMETER	SYMBOL	TEST CONDITION	MIN.	TYP.	MAX.	UNIT
Slew Rate	SR	$R_L=10k\Omega$ to 1.5V	-	0.7	-	$V/\mu s$

■ELECTRICAL CHARACTERISTICS [Amplifier Operating]

●DC CHARACTERISTICS

($V_{DD}=2.2V, 1.54V \leq V_{SD} \leq 2.2V, T_a=25^\circ C$)

PARAMETER	SYMBOL	TEST CONDITION	MIN.	TYP.	MAX.	UNIT
Operating Current	I_{DD}	No Signal Apply, $V_{SD}=V_{DD}$	-	300	500	μA
Input Offset Voltage	V_{IO}		-	-	10	mV
Input Bias Current	I_B		-	1	-	pA
Input Offset Current	I_{IO}		-	1	-	pA
Large Signal Voltage Gain	A_V	$R_L=10k\Omega$ to 1.1V, $V_o=1.1V \pm 1.0V$	70	90	-	dB
Common Mode Rejection Ratio	CMR	CMR+: $1.1V \leq V_{CM} \leq 2.2V$ CMR-: $0V \leq V_{CM} \leq 1.1V$ (Note 7)	30	60	-	dB
Supply Voltage Rejection Ratio	SVR	$2.2V \leq V_{DD} \leq 2.7V$, $V_{CM}=V_{DD}/2, V_{SD}=V_{DD}$	45	70	-	dB
Output Voltage1	V_{OH1}	$R_L=10k\Omega$ to 1.1V	2.15	-	-	V
	V_{OL1}	$R_L=10k\Omega$ to 1.1V	-	-	0.05	V
Output Voltage2	V_{OH2}	$R_L=600\Omega$ to 1.1V	2.1	-	-	V
	V_{OL2}	$R_L=600\Omega$ to 1.1V	-	-	0.1	V
Output Source Current	I_{SOURCE}	$V_o=1.1V$	10	15	-	mA
Output Sink Current	I_{SINK}	$V_o=1.1V$	10	15	-	mA
Input Common Mode Voltage Range	V_{ICM}	CMR $\geq 30dB$	0	-	2.2	V

(Note 7) CMR is represented by either CMR+ or CMR- has lower value.

●AC CHARACTERISTICS

($V_{DD}=2.2V, 1.54V \leq V_{SD} \leq 2.2V, T_a=25^\circ C$)

PARAMETER	SYMBOL	TEST CONDITION	MIN.	TYP.	MAX.	UNIT
Unity Gain Bandwidth	GB	$R_L=10k\Omega$ to 1.1V	-	0.8	-	MHz
Total Harmonic Distortion	THD	$f=1kHz, V_{IN}=1V_{pp}, A_V=0dB$	-	0.05	-	%
Equivalent Input Noise Voltage	V_{NI}	$f=1kHz$	-	40	-	nV/\sqrt{Hz}

●TRANSIENT CHARACTERISTICS

($V_{DD}=2.2V, 1.54V \leq V_{SD} \leq 2.2V, T_a=25^\circ C$)

PARAMETER	SYMBOL	TEST CONDITION	MIN.	TYP.	MAX.	UNIT
Slew Rate	SR	$R_L=10k\Omega$ to 1.1V	-	0.6	-	$V/\mu s$

■ TYPICAL CHARACTERISTICS

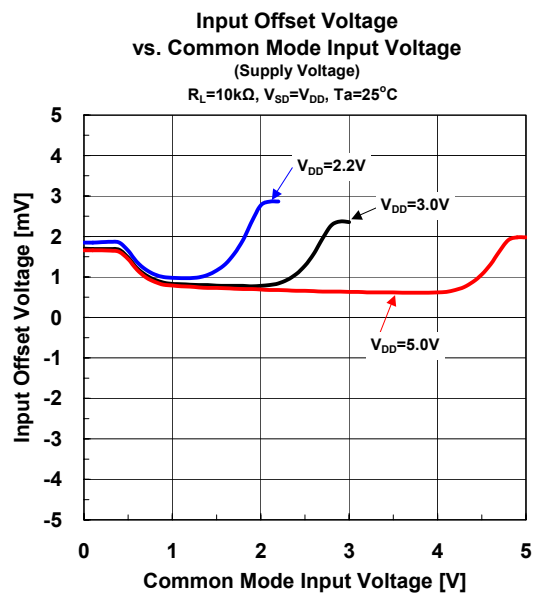
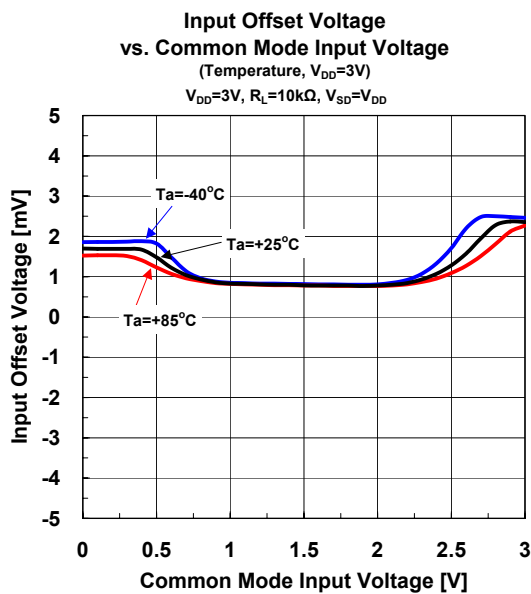
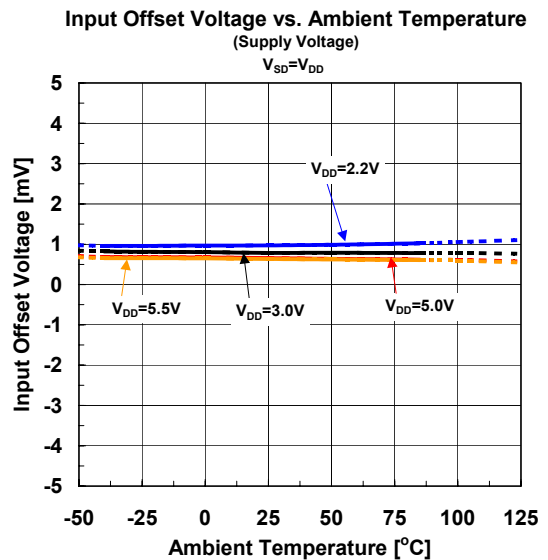
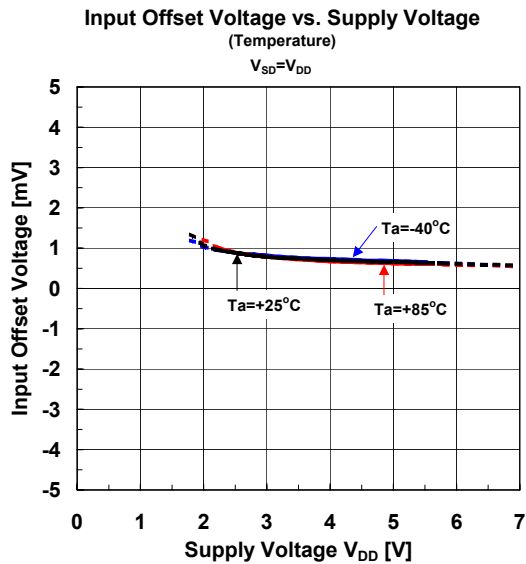
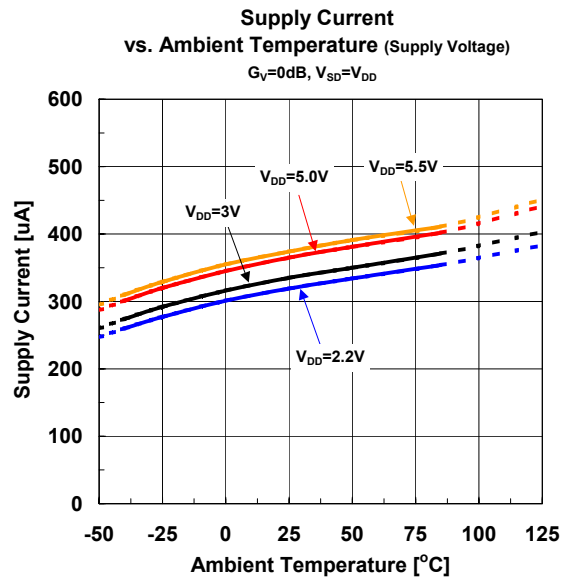
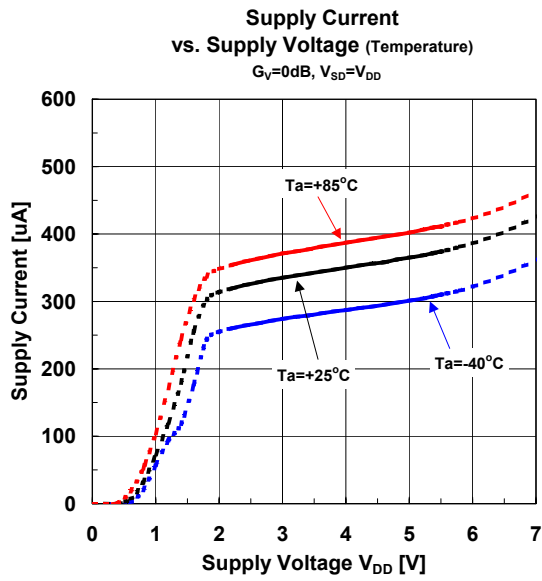

TYPICAL CHARACTERISTICS

Maximum Output Voltage vs. Supply Voltage
(Temperature)

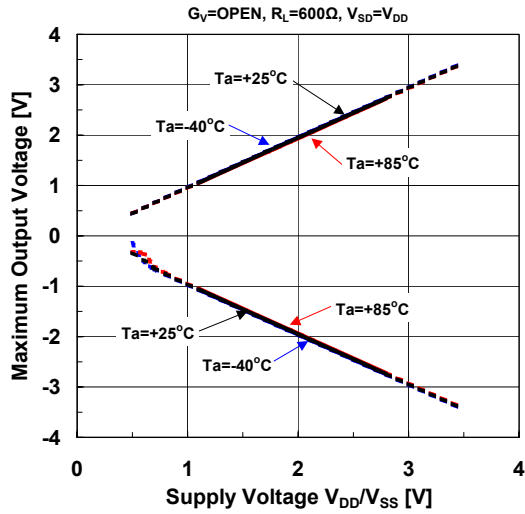

Maximum Output Voltage vs. Ambient Temperature (Supply Voltage)

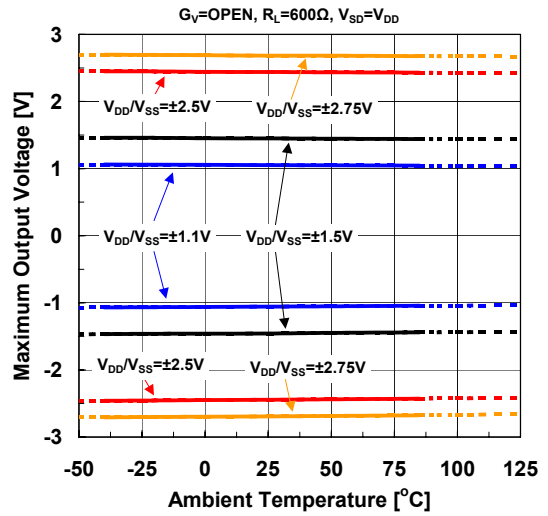

Maximum Output Voltage vs. Load Resistance (Temperature)

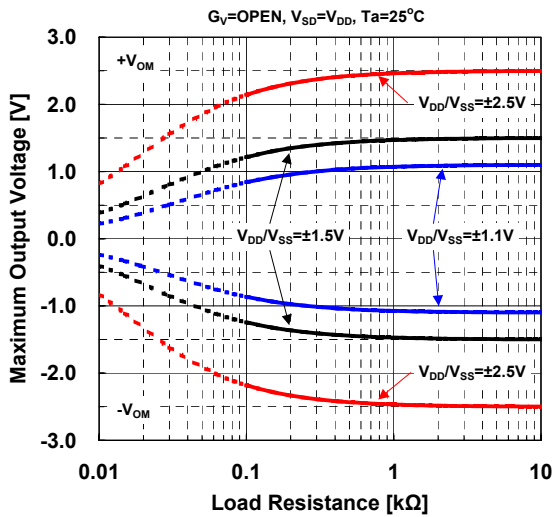

Maximum Output Voltage vs. Output Current (Supply Voltage)

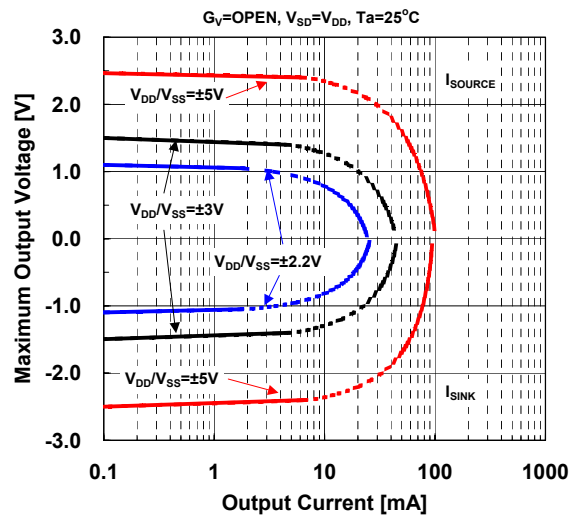

Maximum Output Voltage vs. Load Resistance (Temperature, V_{DD}=3V)

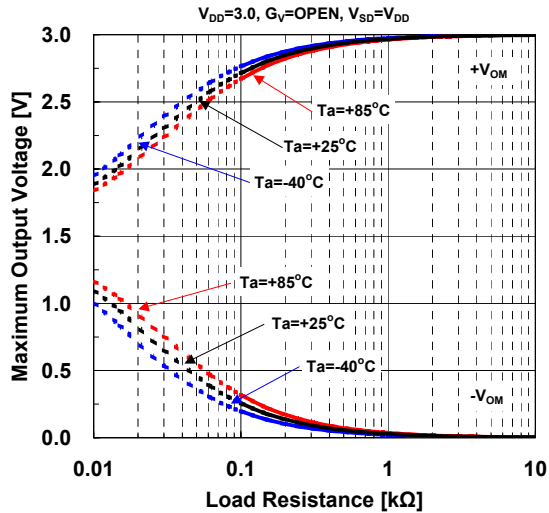

Maximum Output Voltage vs. Output Current (Temperature, V_{DD}=3V)

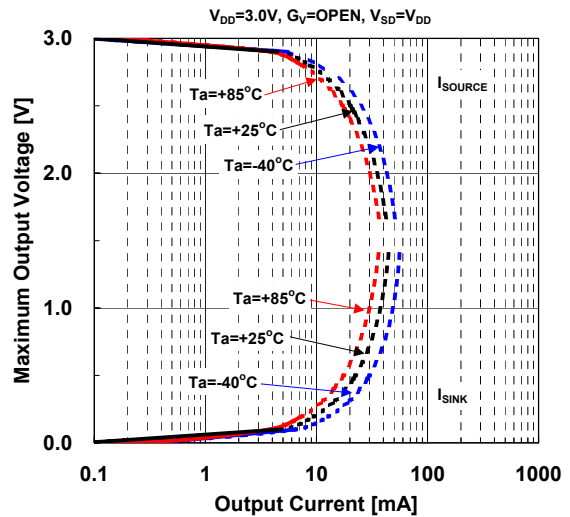

■ TYPICAL CHARACTERISTICS

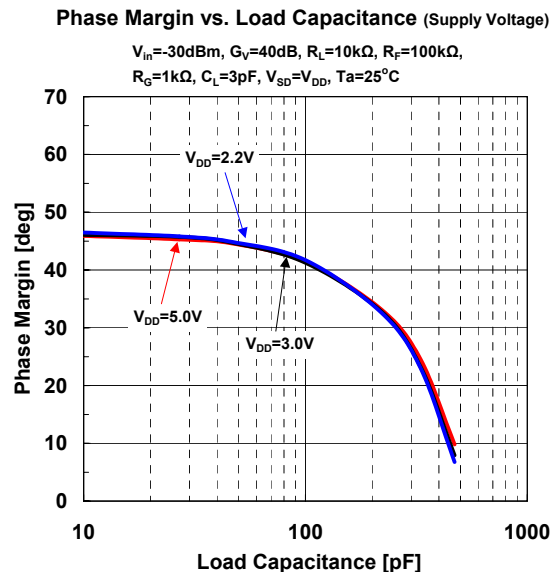
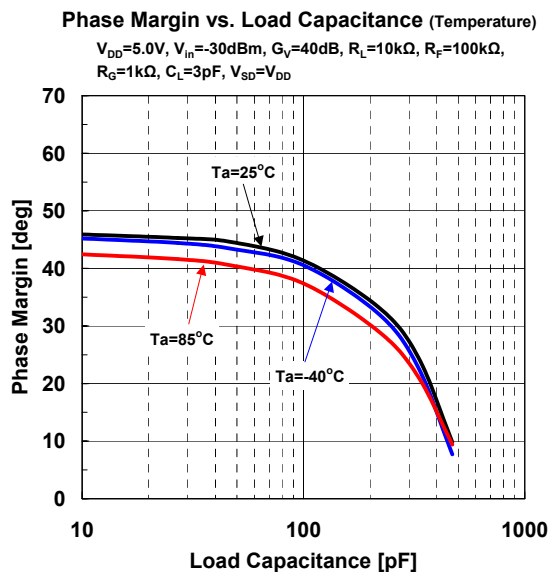
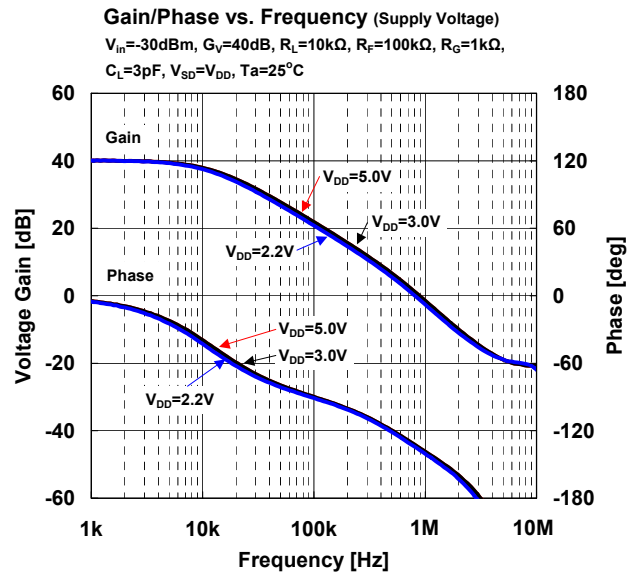
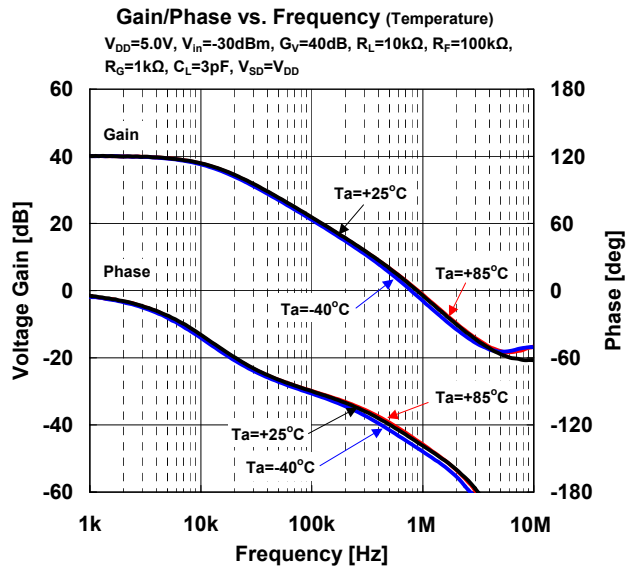
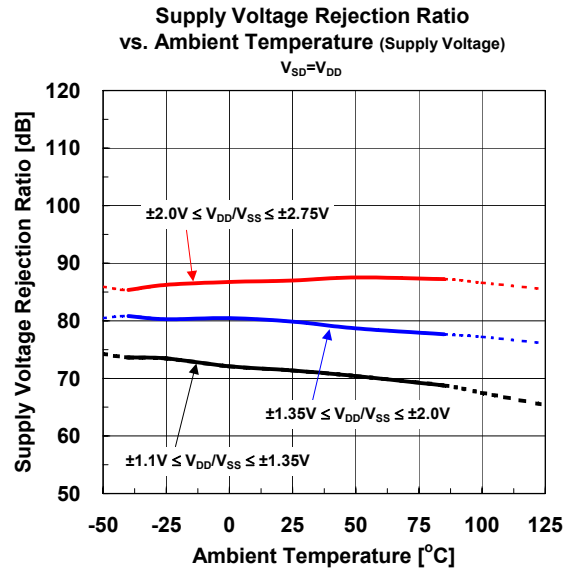
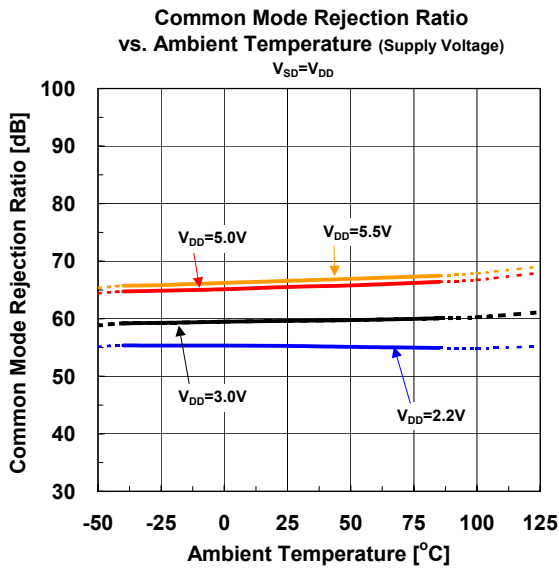

■ TYPICAL CHARACTERISTICS

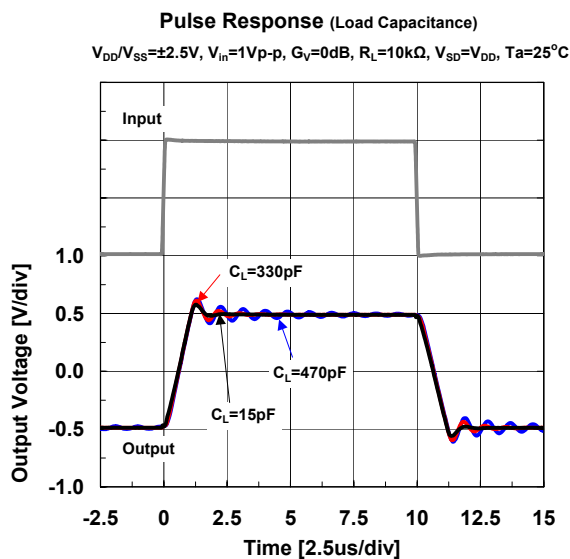
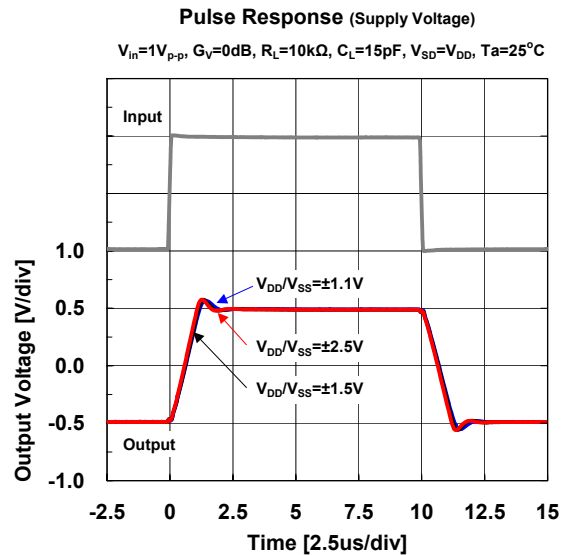
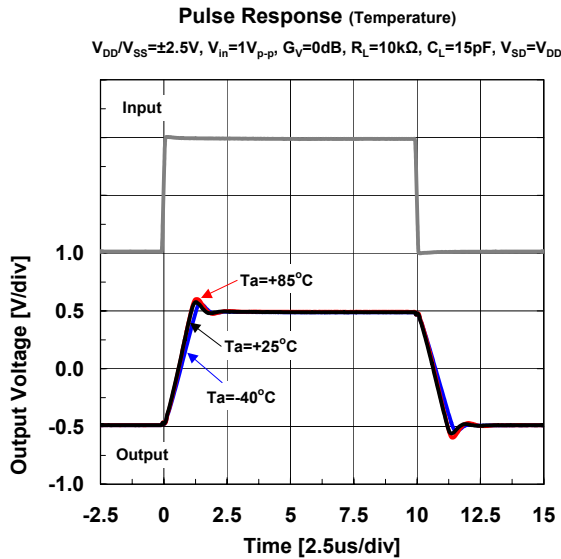
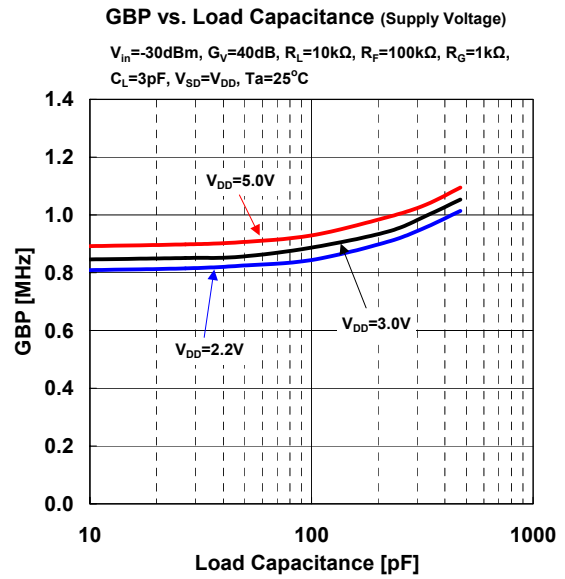
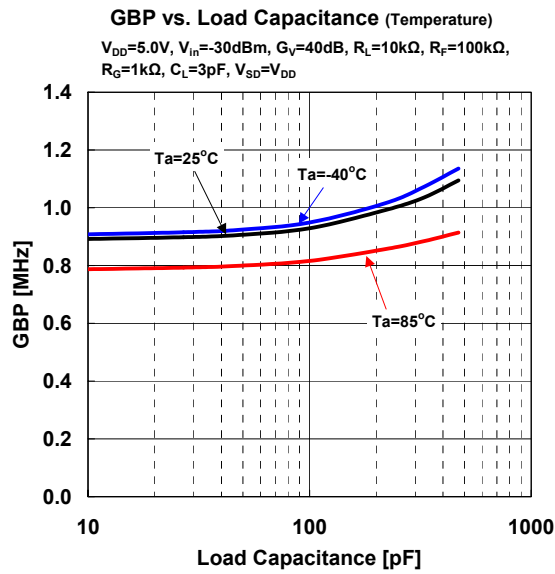

■ TYPICAL CHARACTERISTICS

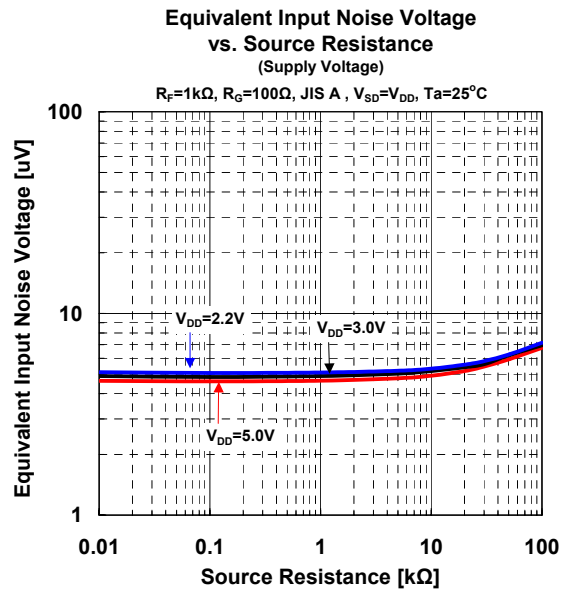
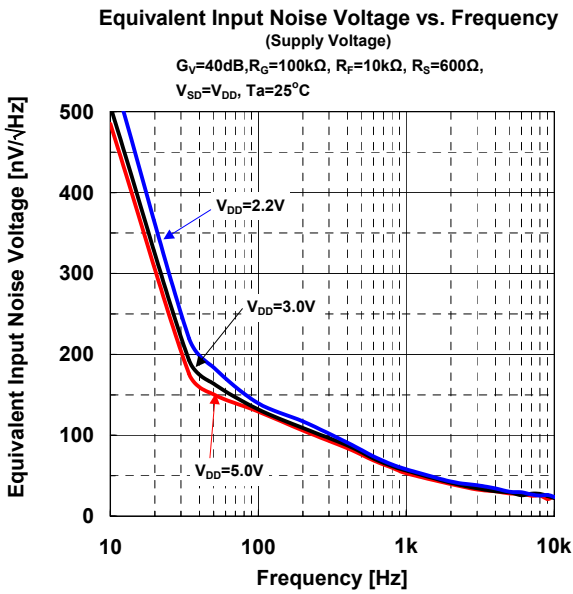
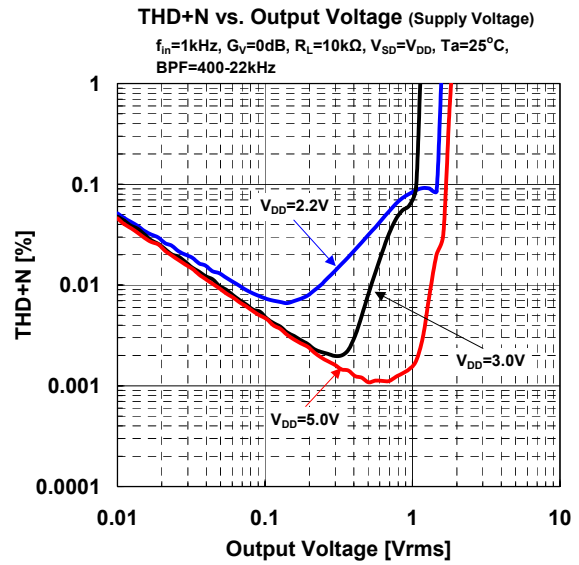
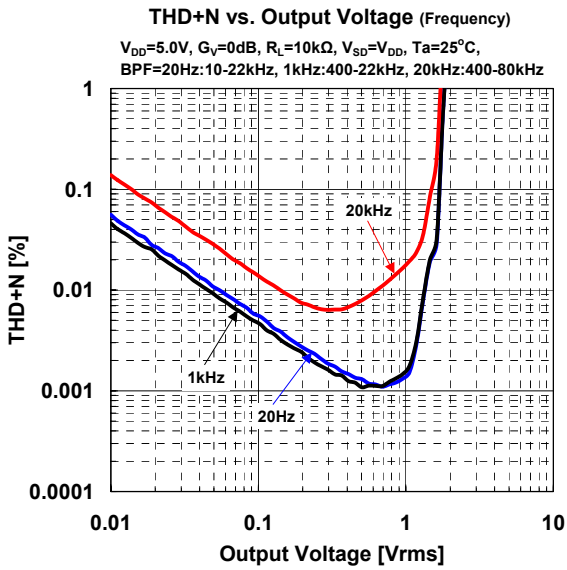

■ TYPICAL CHARACTERISTICS

Supply Current vs. Turn - ON/OFF Control Voltage
(Temperature, $V_{DD}=5V$)
 $V_{DD}=5.0V, G_V=0dB$

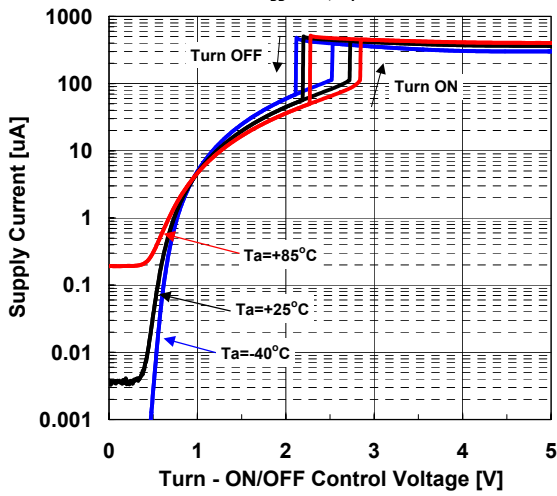

Supply Current vs. Turn - ON/OFF Control Voltage
(Temperature, $V_{DD}=3V$)
 $V_{DD}=3.0V, G_V=0dB$

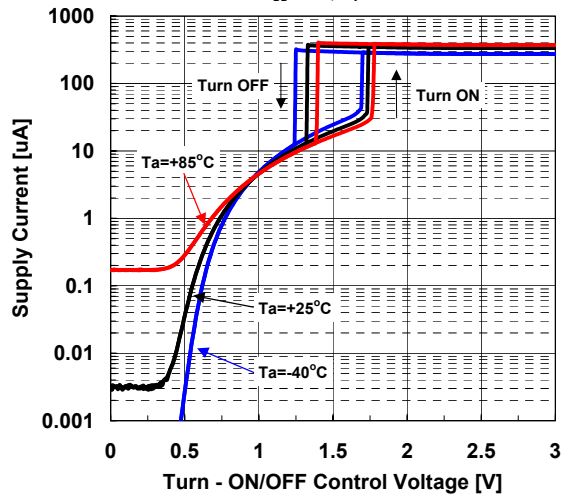

Supply Current vs. Turn - ON/OFF Control Voltage
(Temperature, $V_{DD}=2.2V$)
 $V_{DD}=2.2V, G_V=0dB$

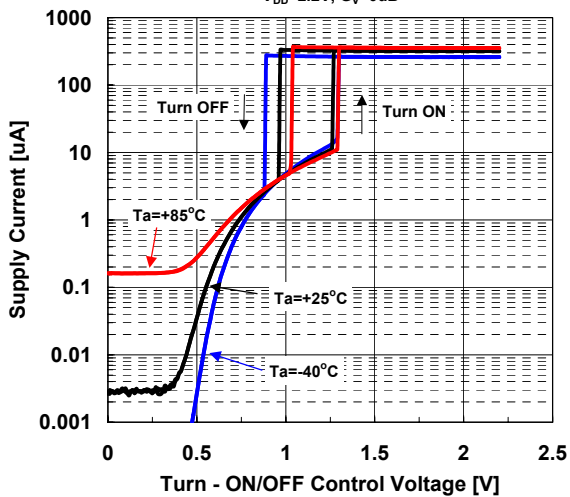

Supply Current when Disabled
vs. Ambient Temperature
 $G_V=0dB, V_{SD}=0.2V$

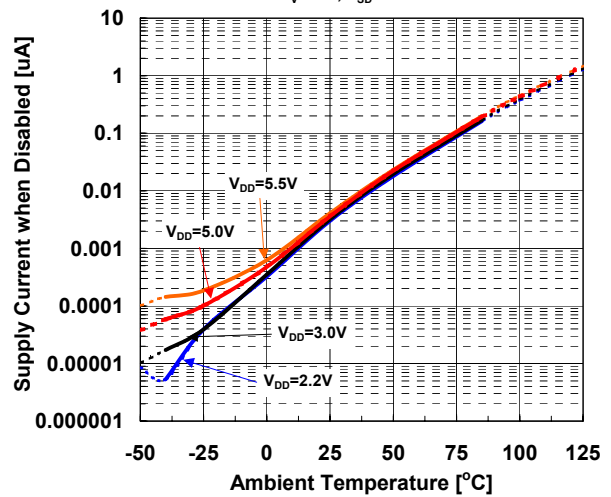

Input Bias Current of SHDN Pin
vs. Ambient Temperature
 $V_{SD}=V_{DD}$

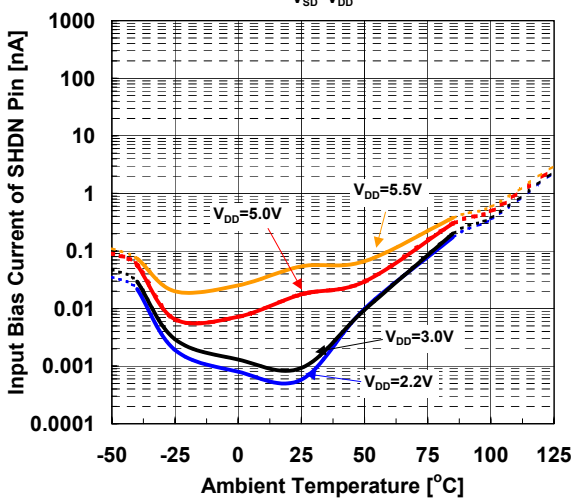

■ TYPICAL CHARACTERISTICS

Output Leak Current vs. Ambient Temperature

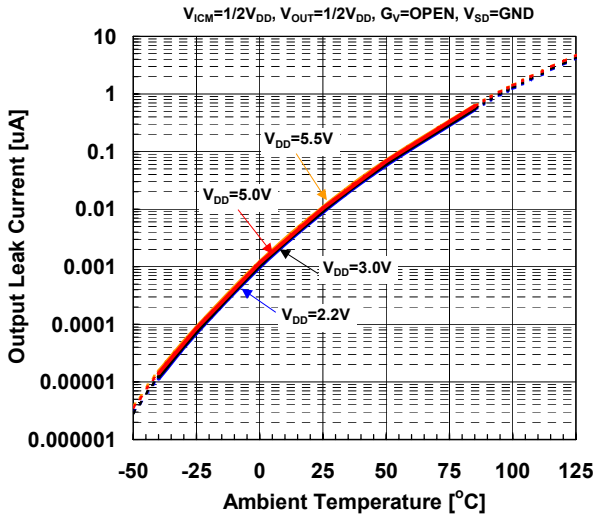

Mute Level vs. Frequency

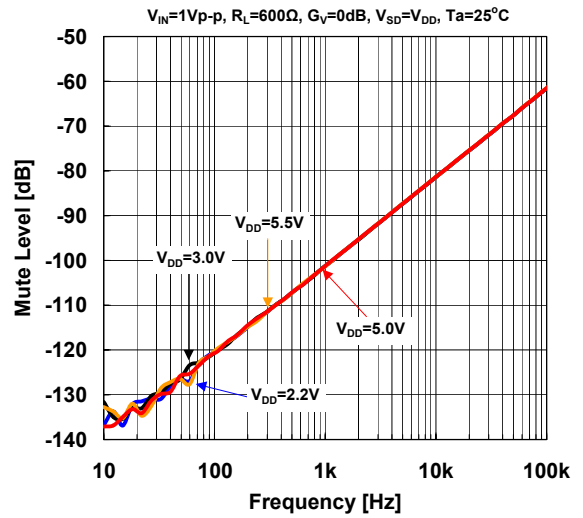

SHDN Pulse Response (Temperature)

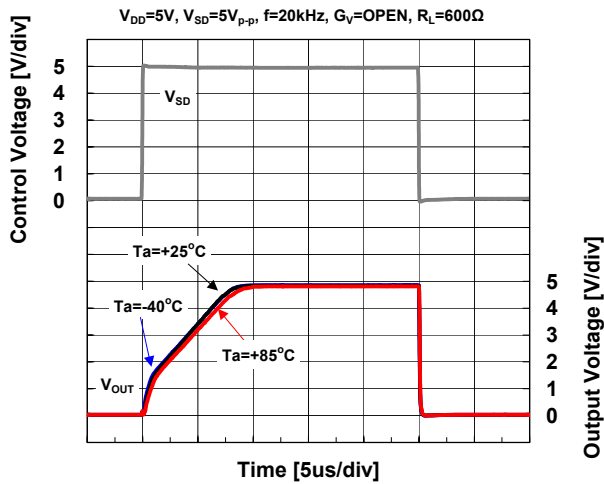

SHDN Pulse Response (Supply Voltage)

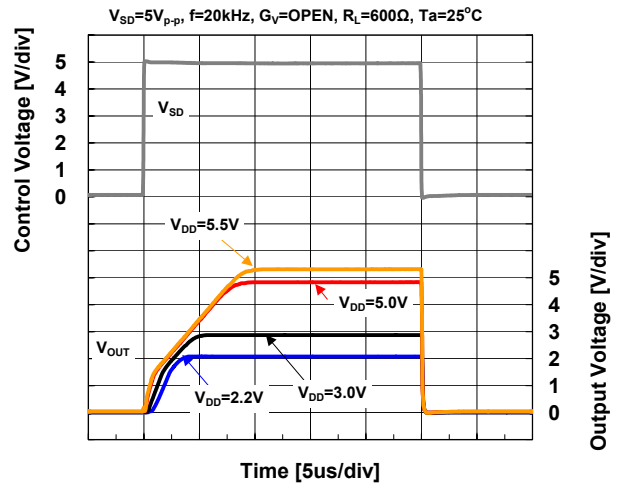

[CAUTION]

The specifications on this data book are only given for information, without any guarantee as regards either mistakes or omissions. The application circuits in this data book are described only to show representative usages of the product and not intended for the guarantee or permission of any right including the industrial rights.