

---

## Designated client product

This product will be discontinued its production in the near term.  
And it is provided for customers currently in use only, with a time limit.  
It can not be available for your new project. Please select other new or existing products.

For more information, please contact our sales office in your region.

New Japan Radio Co.,Ltd.

<http://www.njr.com/>

## 3-INPUT / 2-INPUT VIDEO SWITCH

### ■ GENERAL DESCRIPTION

The **NJM2506** is video switch for video and audio signal. It contains 3 input-1 output and 2 input-1 output video switch. 3 input-1 output switch has clamp function and so is applied to fixed DC level of video signal. Its operating voltage is 4.75 to 13V and bandwidth is 10MHz. Crosstalk is 75dB (at  $f = 4.43\text{MHz}$ )

### ■ PACKAGE OUTLINE

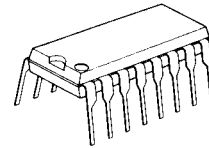

**NJM2506D**

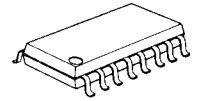

**NJM2506M**

### ■ FEATURES

- Wide Operating Supply Range (+4.75V to +13V)
- 3 Input-1 Output and 2 Input-1 Output
- Internal Clamp Function
- Crosstalk 75dB (at 4.43MHz)
- Wide Frequency Range 10MHz (2V<sub>P-P</sub> Input)
- Package Outline DIP16, DMP16
- Bipolar Technology

### ■ RECOMMENDED OPERATING CONDITION

- Operating Voltage V<sup>+</sup> 4.75V to 13.0V

### ■ APPLICATION

- VCR, Video Camera, AV-TV, Video Disk Player.

### ■ BLOCK DIAGRAM

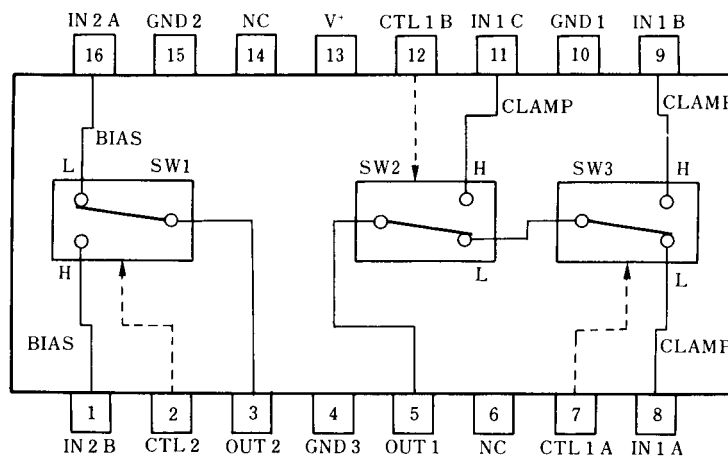

**NJM2506D**

**NJM2506M**



## ■ PIN FUNCTION

PIN No.	PIN NAME	DC VOLTAGE	INSIDE EQUIVALENT CIRCUIT
16 1	IN 2A IN 2B [Input]	2.5V	
8 9 11	IN 1A IN 1B IN 1C [Input]	1.5V	
7 12 2	CTL 1A CTL 1B CTL 2 [Control]		
5	OUT1 [Output]	1.8V	
3	OUT2 [Output]	0.8V	
13	V <sup>+</sup>	5V	
15 4 10	GND 1 GND 2 GND 3		

## ■ TYPICAL CHARACTERISTICS (Ta = +25°C)

### Operating Current vs. Operating Voltage

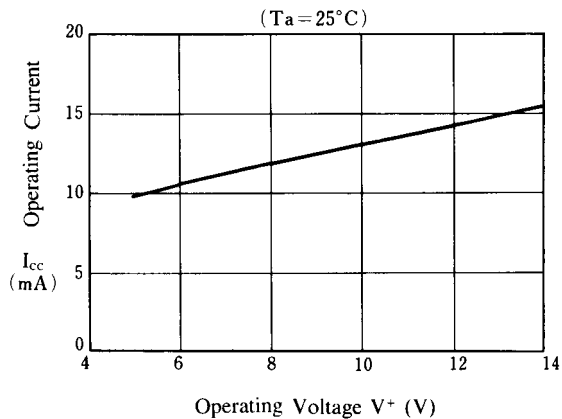

### Operating Current vs. Ambient Temperature

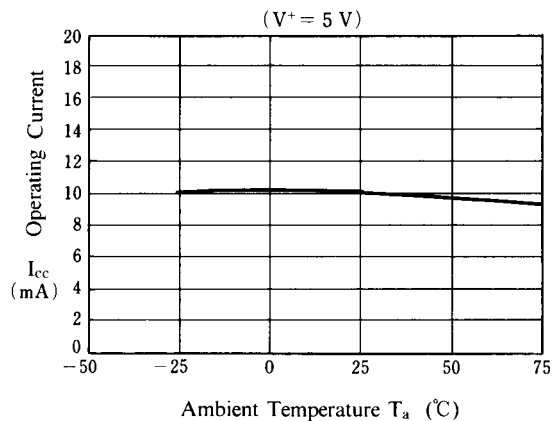

### Operating Current vs. Ambient Temperature

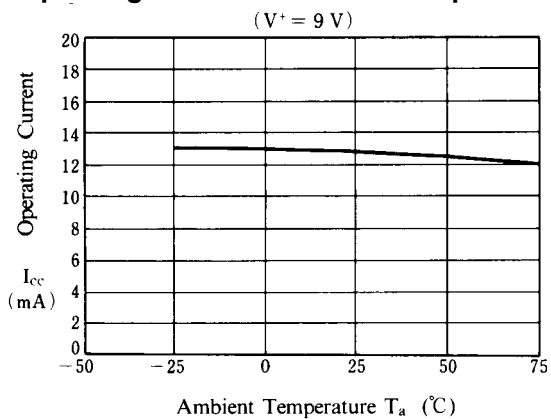

### Voltage Gain vs. Operating Voltage

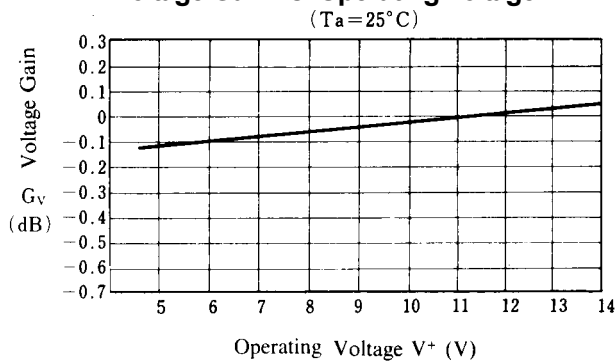

### Voltage Gain vs. Frequency

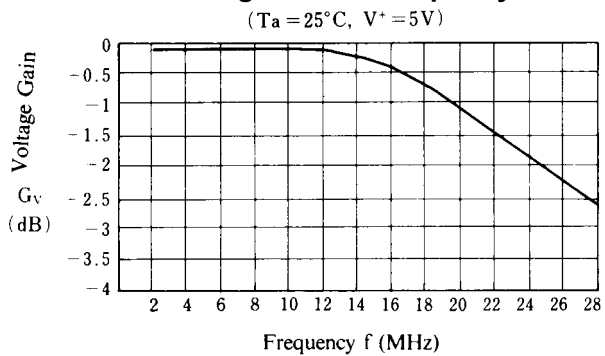

### Voltage Gain vs. Ambient Temperature

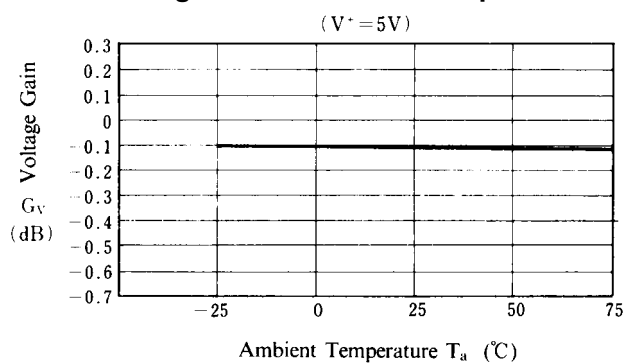

## ■ TYPICAL CHARACTERISTICS (T<sub>a</sub> = +25°C)

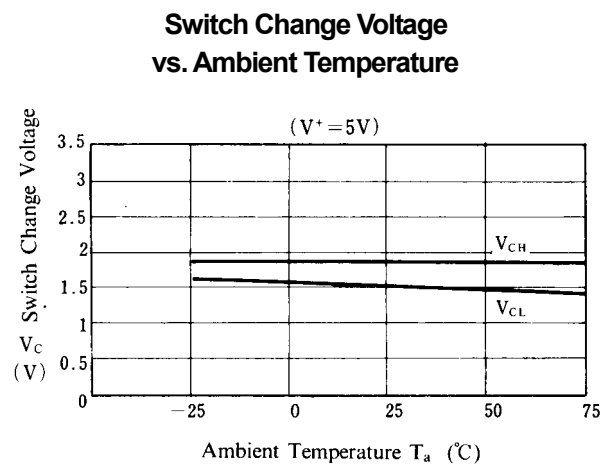
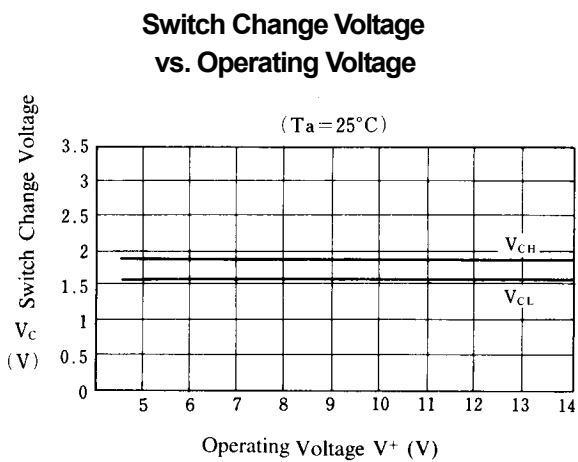
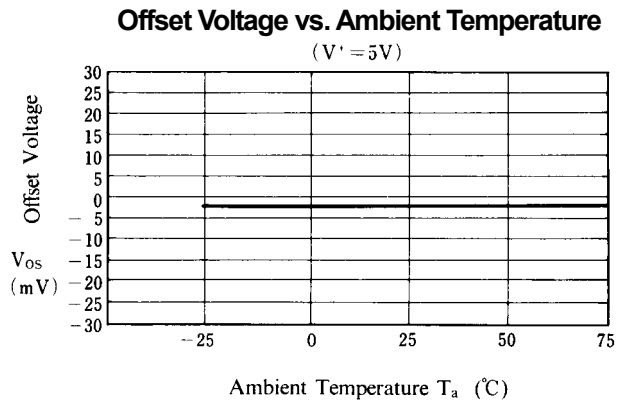
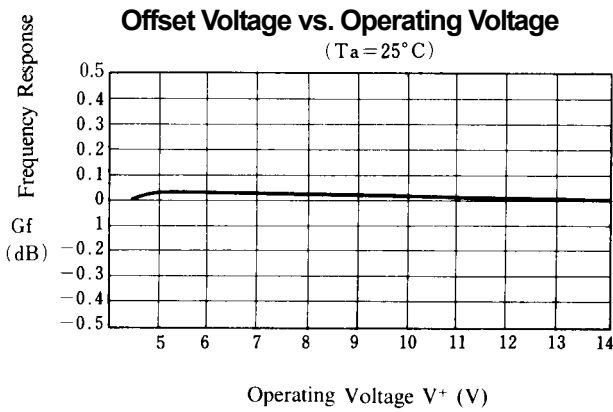
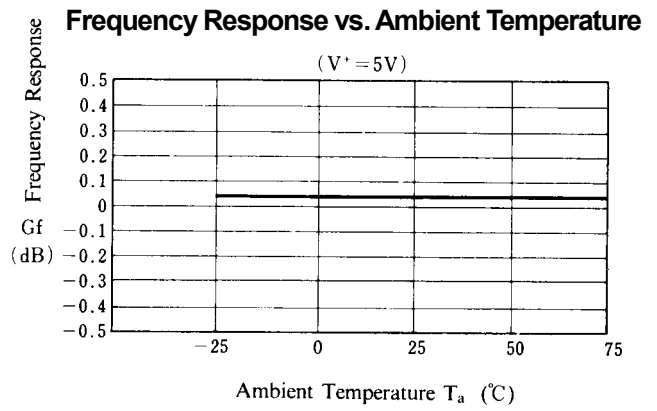
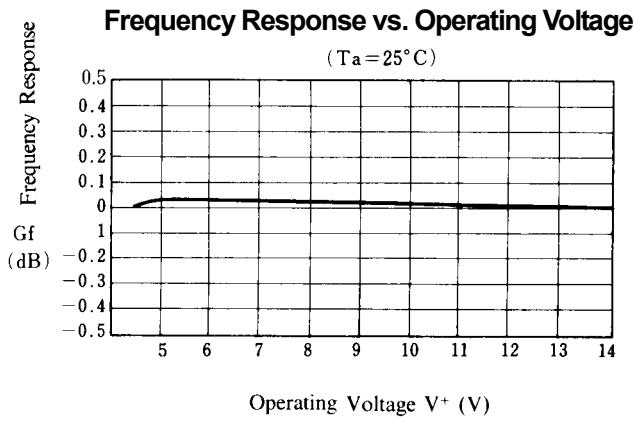

## ■ TYPICAL CHARACTERISTICS (Ta = +25°C)

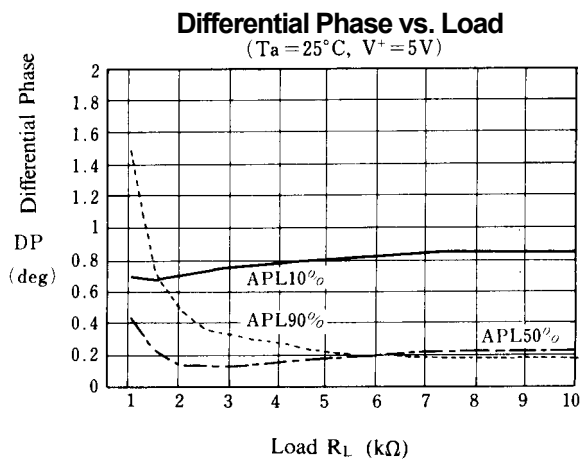
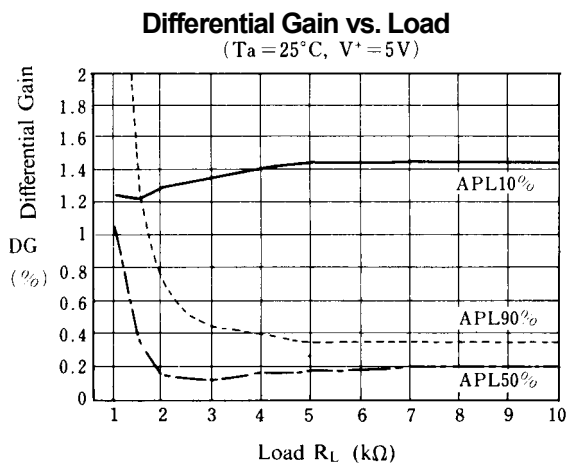
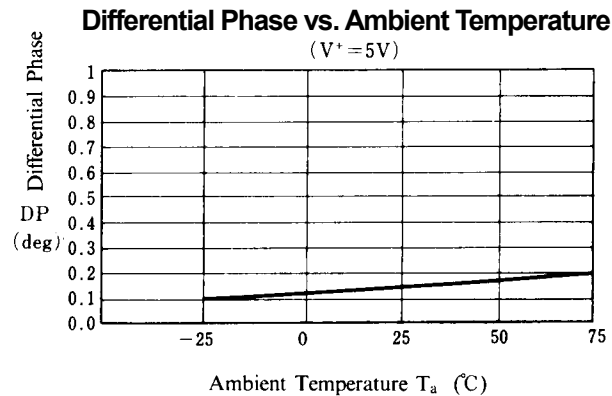
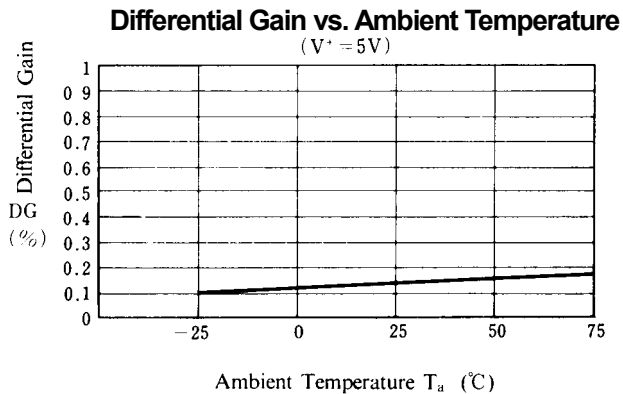
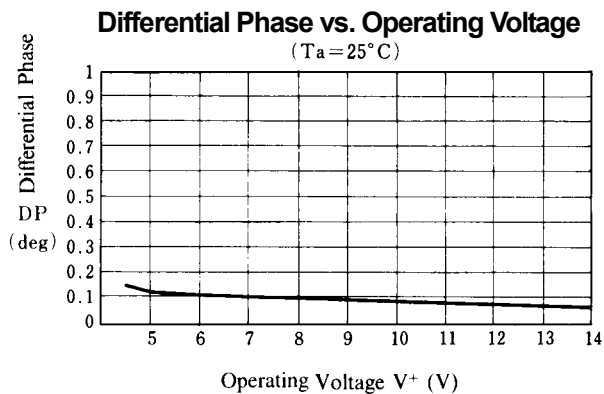
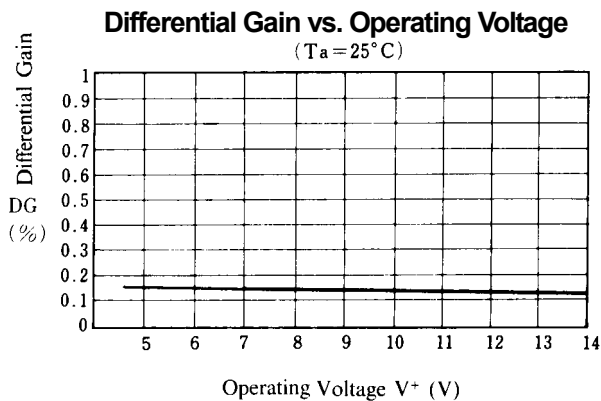

■ TYPICAL CHARACTERISTICS (Ta = +25°C)

**Differential Gain vs. APL**

(Ta = 25°C, V+ = 5V)

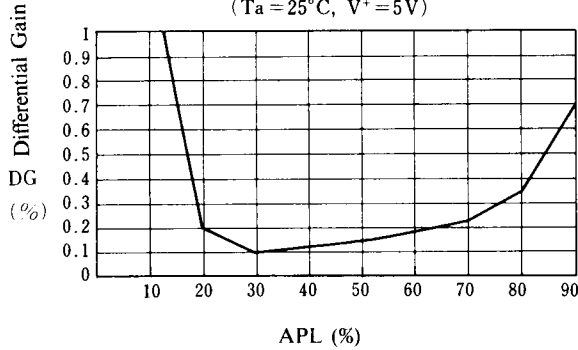

**Differential Phase vs. APL**

(Ta = 25°C, V+ = 5V)

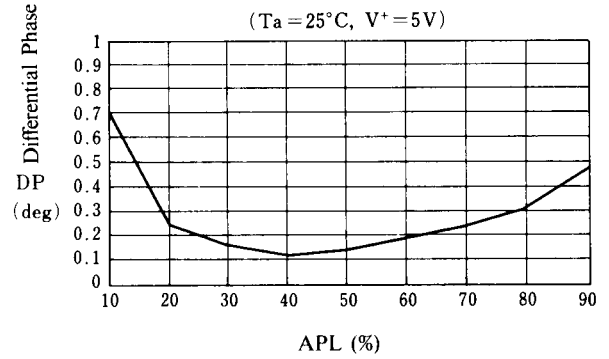

**Differential Gain vs. Load**

(Ta = 25°C, V+ = 5V)

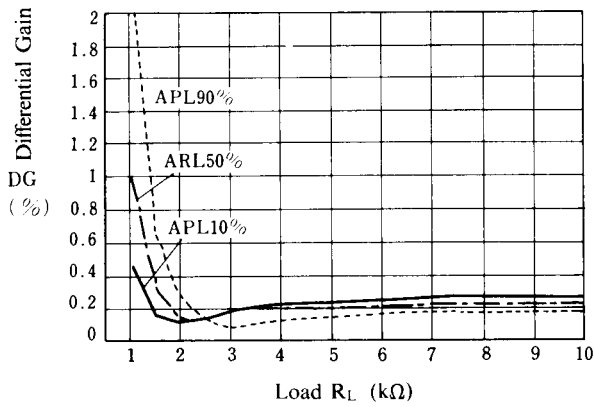

**Differential Phase vs. Load**

(Ta = 25°C, V+ = 5V)

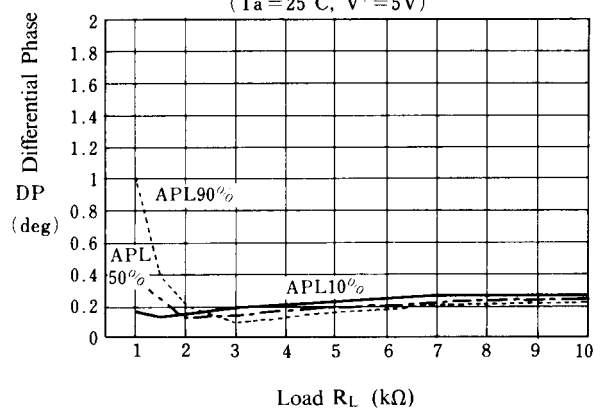

**Differential Gain vs. APL**

(Ta = 25°C, V+ = 5V)

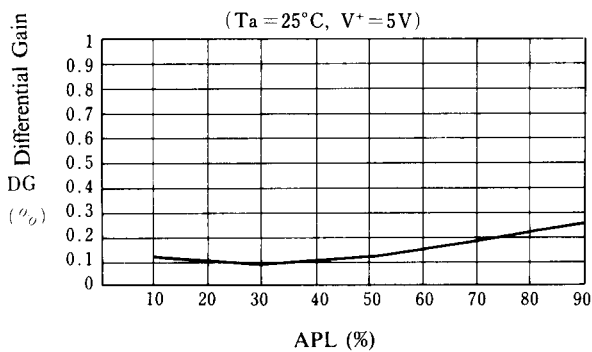

**Differential Phase vs. APL**

(Ta = 25°C, V+ = 5V)

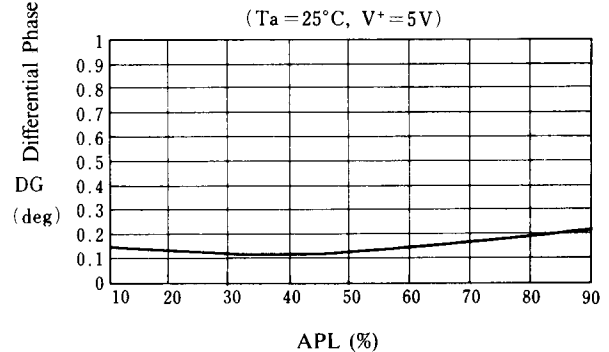



## ■ TYPICAL CHARACTERISTICS (Ta = +25°C)

**Crosstalk (IN2A to OUT2) vs. Operating Voltage**  
(Ta = 25°C)

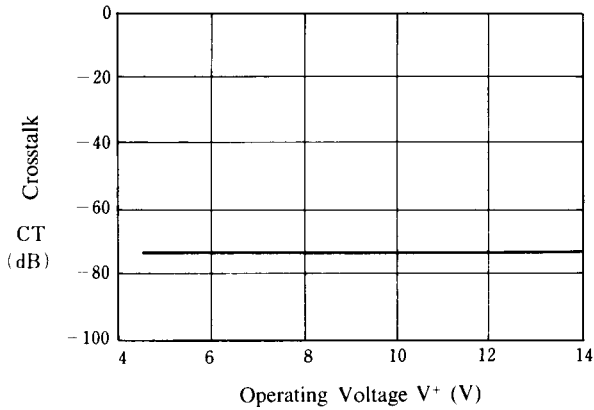

**Crosstalk (IN2A to OUT2) vs. Ambient Temperature**  
(V<sup>+</sup> = 5V)

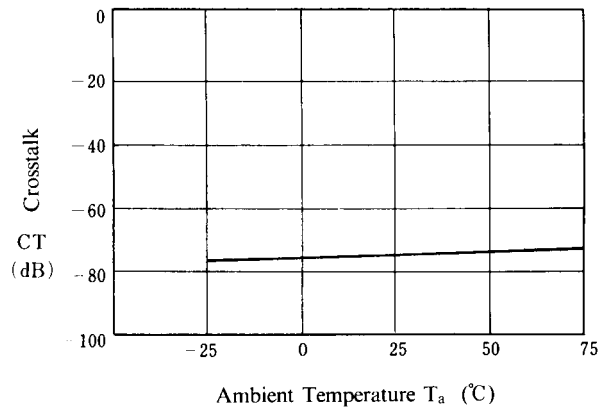

**Crosstalk (IN1B to OUT1) vs. Operating Voltage**  
(Ta = 25°C)

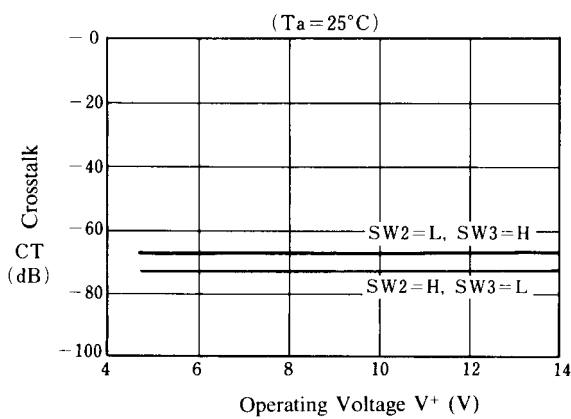

**Crosstalk (IN1B to OUT1) vs. Ambient Temperature**  
(V<sup>+</sup> = 5V)

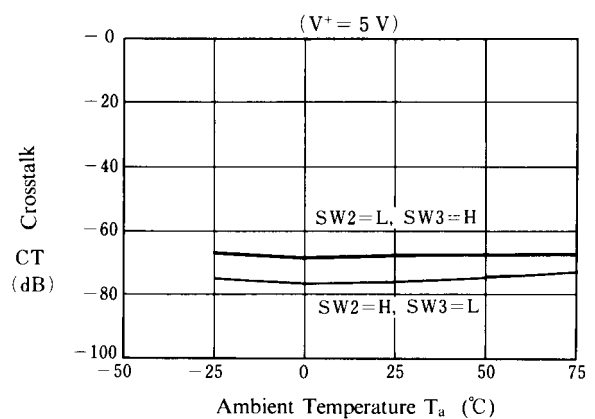

**Crosstalk (IN1B to OUT1) vs. Operating Voltage**  
(Ta = 25°C)

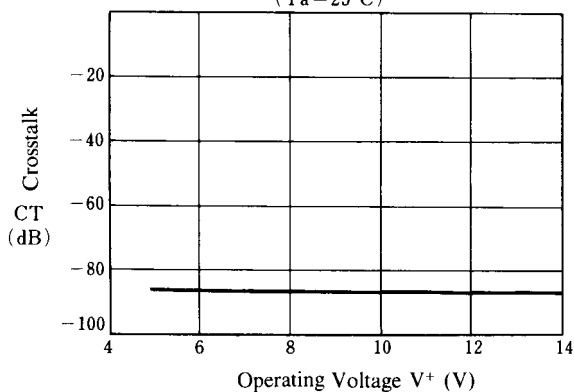

**Crosstalk (IN1B to OUT1) vs. Ambient Temperature**  
(V<sup>+</sup> = 5V)

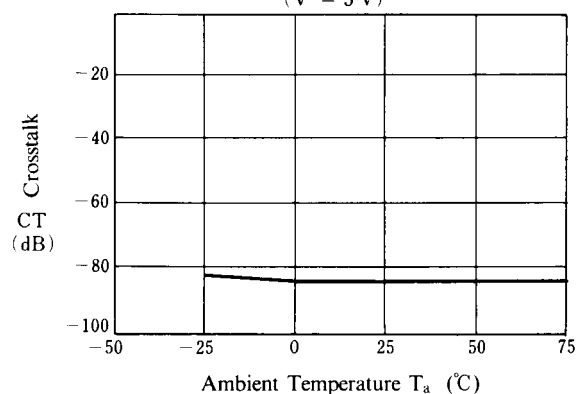

■ TYPICAL CHARACTERISTICS (T<sub>a</sub> = +25°C)

Total Harmonic Distortion vs. Load

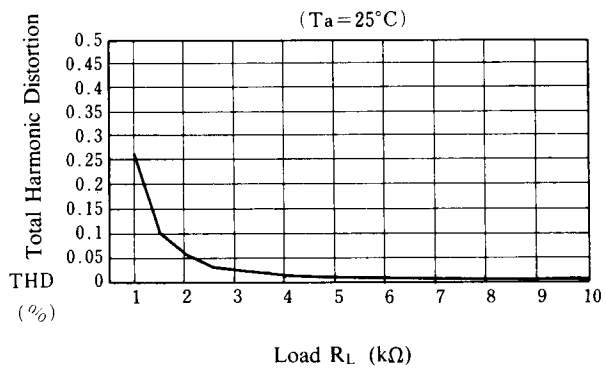

# NJM2506

## ■ APPLICATION

This IC requires  $1M\Omega$  resistance between INPUT and GND pin for clamp type input since the minute current causes an unstable pin voltage.

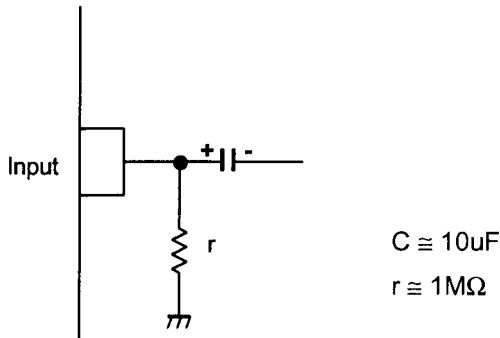

This IC requires  $0.1\mu\text{F}$  capacitor between INPUT and GND,  $1M\Omega$  resistance between INPUT and GND for clamp type input at mute mode.

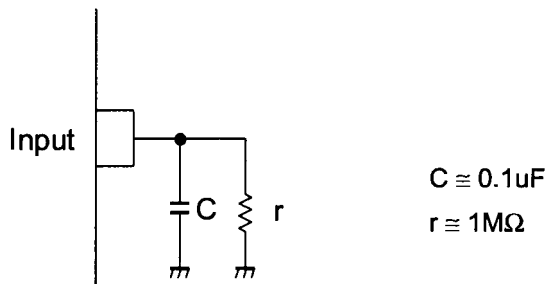

This IC requires  $0.1\mu\text{F}$  capacitor between INPUT and GND for bias type input at mute mode.

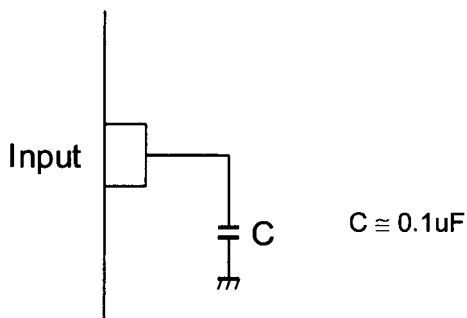

[CAUTION]  
The specifications on this databook are only given for information, without any guarantee as regards either mistakes or omissions. The application circuits in this databook are described only to show representative usages of the product and not intended for the guarantee or permission of any right including the industrial rights.