

NJW4840

■ ABSOLUTE MAXIMUM RATINGS

(Ta=25°C)

PARAMETER	SYMBOL	RATINGS	UNIT	REMARK
Supply Voltage	V _{DD}	+24	V	VDD-GND Pin
Input Voltage	V _{IN}	-0.3 to +6	V	IN-GND Pin
Input Voltage (Pulse)	V _{IN-pulse}	-0.3 to +7	V	
Power Dissipation	P _D	720 (*1) 1100 (*2)	mW	-
Junction Temperature	T _j	-40 to +150	°C	-
Operating Temperature	T _{opr}	-40 to +105	°C	-
Storage Temperature	T _{stg}	-50 to +150	°C	-

(*1): Mounted on glass epoxy board. (76.2×114.3×1.6mm:based on EIA/JDEC standard, 2Layers)

(*2): Mounted on glass epoxy board. (76.2×114.3×1.6mm:based on EIA/JDEC standard, 4Layers),

internal Cu area: 74.2×74.2mm

■ RECOMMENDED OPERATING CONDITIONS

(Ta=25°C)

PARAMETER	SYMBOL	MIN.	TYP.	MAX.	UNIT	REMARK
Operating Voltage	V _{DD}	8.0	-	20	V	VDD-GND Pin
Input Voltage	V _{IN}	0	-	5.5	V	IN-GND Pin

■ ELECTRICAL CHARACTERISTICS

(Unless otherwise noted, $V_{DD}=16V$, $T_a=25^\circ C$)

PARAMETER	SYMBOL	TEST CONDITIONS	MIN.	TYP.	MAX.	UNIT
General						
Quiescent Current	I_{Q1}	$V_{IN}=5V$	–	0.93	1.6	mA
	I_{Q2}	$V_{IN}=0V$	–	0.7	1.4	mA

Output Block

Output Peak Current	I_{PK1}	$PW \leq 400ns, V_{OUT}=0V$	–	4	–	A
	I_{PK2}	$PW \leq 400ns, V_{OUT}=16V$	–	4	–	A
Output ON Resistance (High-Side / Low-Side)	R_{DSH}	$I_{O-SOURCE}=100mA$	–	0.8	1.5	Ω
	R_{DSL}	$I_{O-SINK}=100mA$	–	0.8	1.5	Ω
Pull Down Resistance	R_{PD}		60	100	140	k Ω

Input Circuit Block

IN Pin High Resistance	V_{IHIN}		3.0	–	5.5	V
IN Pin Low Resistance	V_{ILIN}		0	–	1.5	V
IN Pin Sink Current	I_{IIN}	$V_{IN}=5.5V$	–	–	1	μA
IN Pin Hysteresis Voltage	ΔV_{in}	$V_{IHIN} - V_{ILIN}$	–	0.3	–	V

UVLO Block

UVLO Release Voltage	V_{UVLO2}		6.3	7	7.7	V
UVLO Operating Voltage	V_{UVLO1}		6	6.7	7.4	V
UVLO Hysteresis Voltage	ΔV_{UVLO}	$V_{UVLO2} - V_{UVLO1}$	–	0.3	–	V

■ OUTPUT RISE / FALL CHARACTERISTICS

($V_{DD}=16V$, $T_a=25^\circ C$, Design Value*)

PARAMETER	SYMBOL	TEST CONDITION	MIN.	TYP.	MAX.	UNIT
Output Rise Time	t_r	$C_L=4700pF, V_{IN}=0$ to 5V	15.0	27.5	40.0	ns
Output Fall Time	t_f	$C_L=4700pF, V_{IN}=5$ to 0V	15.0	27.5	40.0	ns
Rise Delay Time	t_{d_ON}	$C_L=4700pF, V_{IN}=0$ to 5V	17.5	30.0	42.5	ns
Fall Delay Time	t_{d_OFF}	$C_L=4700pF, V_{IN}=5$ to 0V	25.0	37.5	50.0	ns

* It is design guaranteed, not tested.

NJW4840

■ TIMING CHART

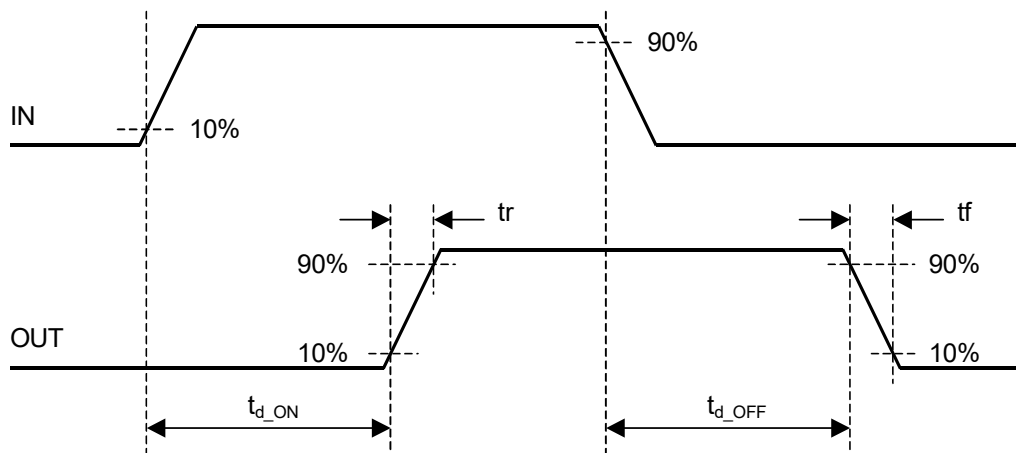

■ PROTECTION CIRCUIT OPERATION

● Under Voltage Lockout (UVLO)

The VDD pin has UVLO function for malfunction prevention at low voltage condition.

When the VDD voltage is less than UVLO Operating Voltage, the output pin is turned off.

When the VDD voltage rises to UVLO Release Voltage, normal operation resumes.

● Thermal Shut Down (TSD)

When the junction temperature reaches to 180°C typ., the output pin is turned off.

When the junction temperature falls to 170°C typ., normal operation resumes.

● Short Circuit Protection (power / ground fault)

The OUT pin has current detection circuit for protection against short-circuit to power and ground.

If the output current exceeding the current detection threshold (about 1.4 A) inside the IC continues to flow for more than about 500ns, the output pin is turned off and retained.

This protected state returns to normal operation when the power-on again or the input signal is switched.

■ TYPICAL APPLICATION

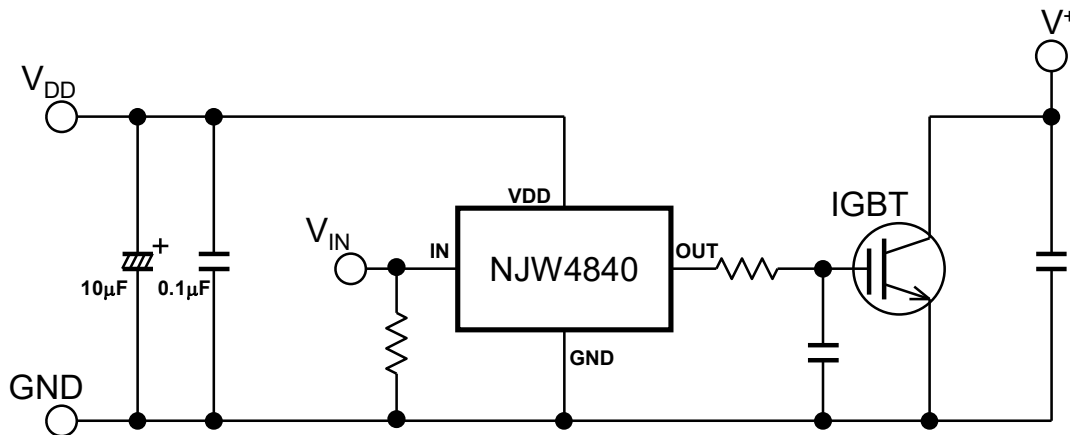

■ APPLICATION TIPS

In the application that does a high-speed switching of NJW4840, because the current flow corresponds to the input frequency, the substrate (PCB) layout becomes an important.

NJW4840 is driving the High-side/Low-side SW gate with high speed to reduce switching losses. The transient voltage is generated by parasitic inductance and a high-speed current change of high side and low side SW.

You should attempt the transition voltage decrease by making a current loop area minimize as much as possible. Therefore, you should make a current flowing line thick and short as much as possible.

You should insert a bypass capacitor between the VDD pin and the GND pin to prevent malfunction by generating over voltage and/or exceed maximum input voltage rating. The recommended bypass capacitor is low ESR and high frequency characteristic (NJR recommends 0.1µF or more).

An aluminum electrolysis capacitor is recommended for smoothing condenser. (NJR recommends 10µF or more). However, you should use large capacitor by sufficient evaluation (assessment) due to load condition and/or application use environment. (There is a possibility that the supply voltage rises by inductive kickback when the supply current of the inductive load is large.)

The bypass capacitors should be connected as much as possible near the VDD pin.

NJW4840

■ TYPICAL CHARACTERISTICS

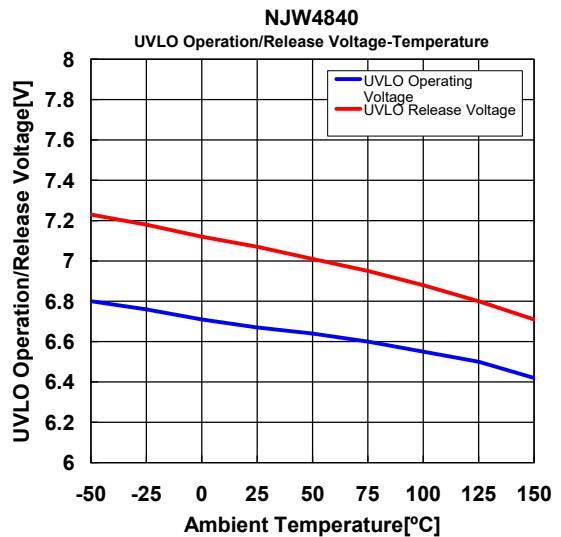
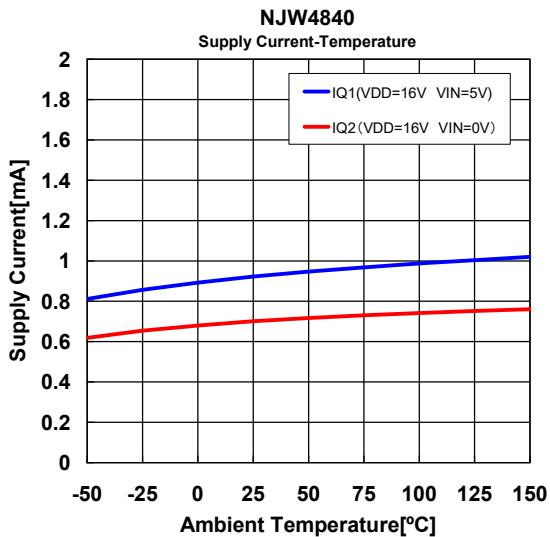
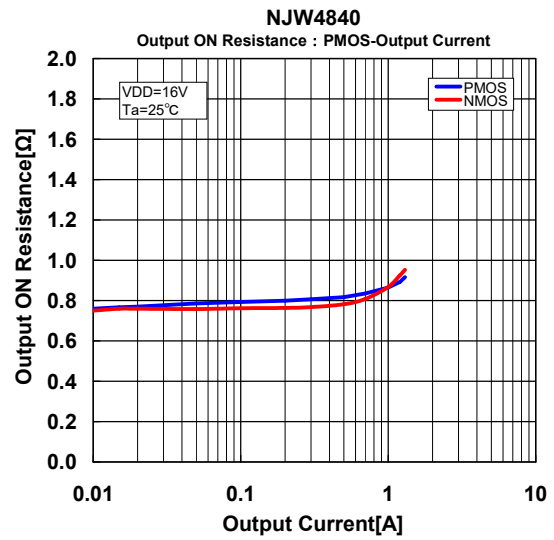
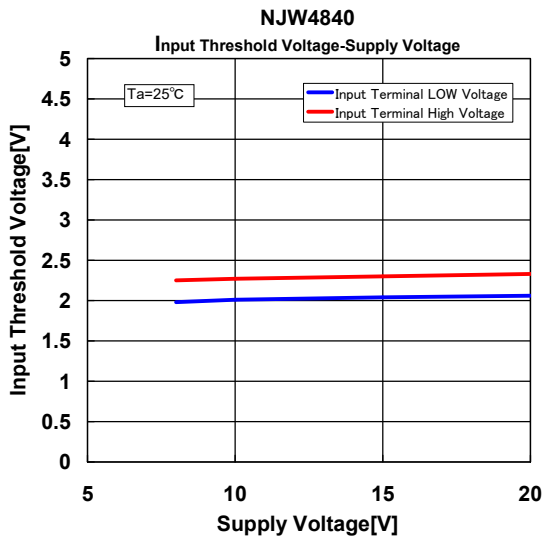
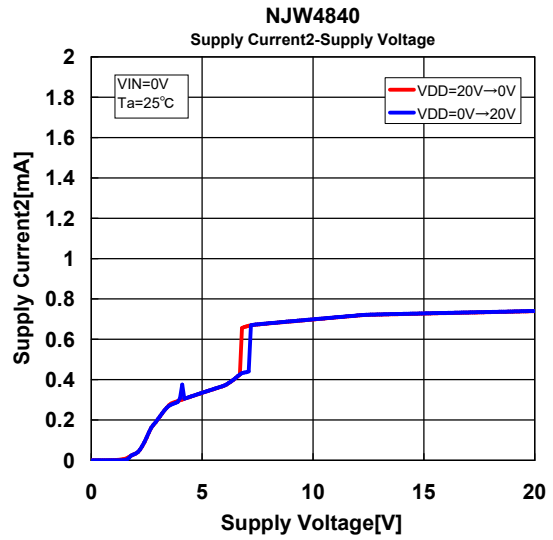
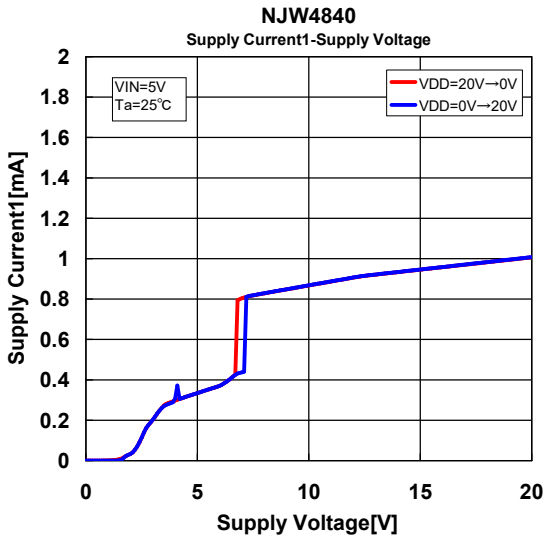

■ TYPICAL CHARACTERISTICS

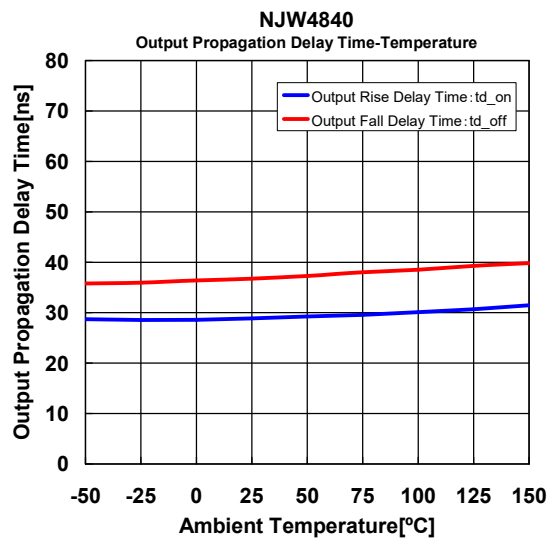
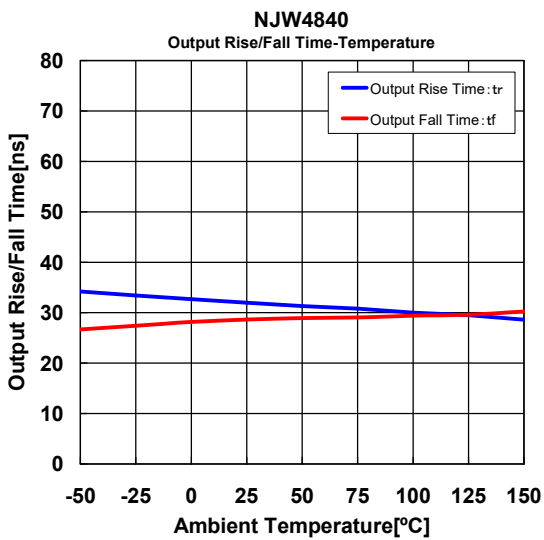
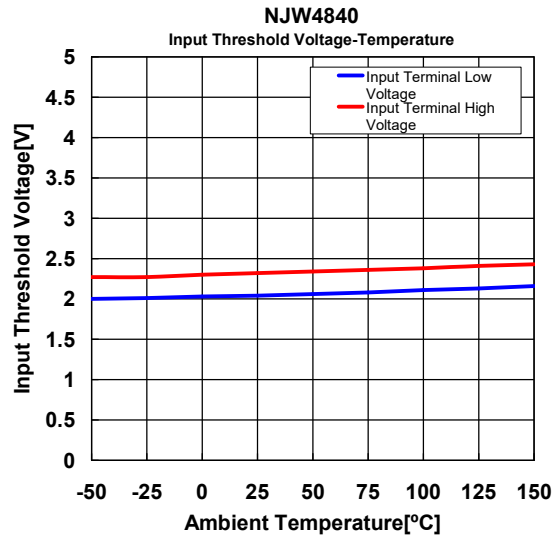
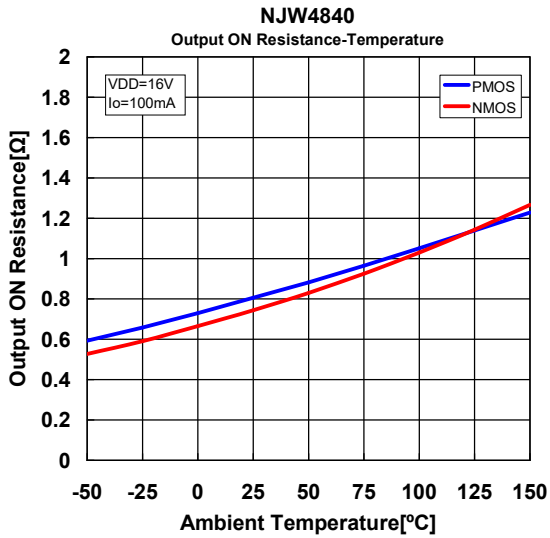

[CAUTION]
The specifications on this datasheets are only given for information , without any guarantee as regards either mistakes or omissions.
The application circuits in this datasheets are described only to show representative usages of the product and not intended for the guarantee or permission of any right including the industrial rights.