

Internal 40V MOSFET Switching Regulator IC for Buck Converter

■ GENERAL DESCRIPTION

The **NJW4150A** is a buck converter with **40V/300mA** MOSFET. It corresponds to high oscillating frequency, and Low ESR Output Capacitor (MLCC) within wide input range from 6.2V to 40V. Therefore, the **NJW4150A** can realize downsizing of an application with a few external parts.

Also, it has a soft start function, an over current protection and a thermal shutdown circuit.

It is suitable for logic voltage generation from high voltage that Car Accessory, Office Automation Equipment, Industrial Instrument and so on.

■ PACKAGE OUTLINE

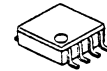

NJW4150ARB1

■ FEATURES

- Maximum Rating Input Voltage 45V
- Wide Operating Voltage Range 6.2V to 40V
- Switching Current 450mA min.
- PWM control
- Correspond to Ceramic Capacitor (MLCC)
- Oscillating Frequency 1MHz typ. (A ver.)
- Soft Start Function 4ms typ.
- UVLO (Under Voltage Lockout)
- Over Current Protection
- Thermal Shutdown Protection
- Standby Function
- Package Outline NJW4150ARB1: MSOP8(TVSP8)* *MEET JEDEC MO-187-DA THIN TYPE

■ PRODUCT CLASSIFICATION

Part Number	Version	Oscillating Frequency	Operating Temperature Range
NJW4150ARB1-A	A	1,000kHz typ.	General Spec. -40°C to +125°C

NJW4150A

■PIN CONFIGURATION

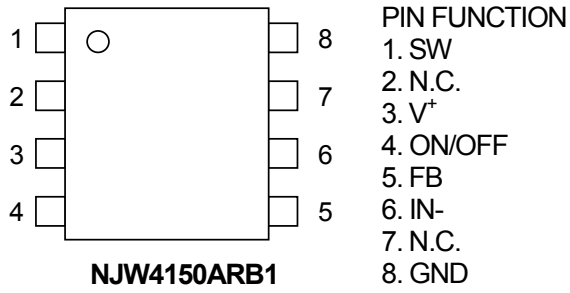

■BLOCK DIAGRAM

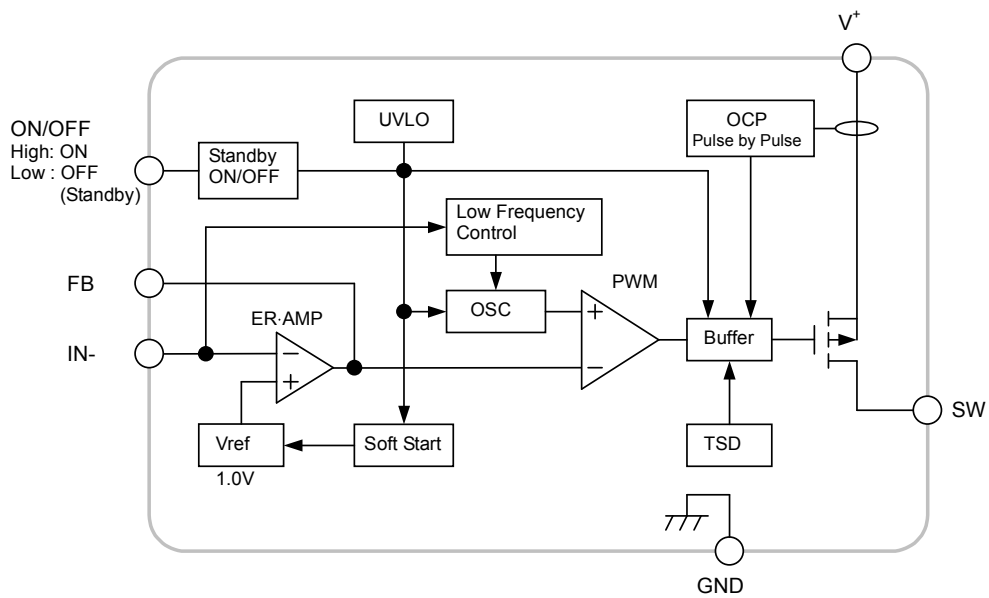

■ ABSOLUTE MAXIMUM RATINGS (Ta=25°C)

PARAMETER	SYMBOL	MAXIMUM RATINGS	UNIT
Supply Voltage	V ⁺	-0.3 to +45	V
V ⁺ - SW pin Voltage	V _{V,SW}	+45	V
IN- pin Voltage	V _{IN-}	-0.3 to +6	V
ON/OFF pin Voltage	V _{ON/OFF}	-0.3 to +45	V
Power Dissipation	P _D	580 (*1) 780 (*2)	mW
Junction Temperature Range	T _j	-40 ~ +150	°C
Operating Temperature Range	T _{opr}	-40 ~ +125	°C
Storage Temperature Range	T _{stg}	-50 ~ +150	°C

(*1): Mounted on glass epoxy board. (76.2×114.3×1.6mm:EIA/JDEC standard size, 2Layers)

(*2): Mounted on glass epoxy board. (76.2×114.3×1.6mm:EIA/JDEC standard size, 4Layers),
internal Cu area: 74.2×74.2mm

■ RECOMMENDED OPERATING CONDITIONS

PARAMETER	SYMBOL	MIN.	TYP.	MAX.	UNIT
Operating Voltage	V ⁺	6.2	—	40	V

NJW4150A

■ ELECTRICAL CHARACTERISTICS ($V^+=V_{ON/OFF}=24V$, $T_a=25^\circ C$)

PARAMETER	SYMBOL	TEST CONDITION	MIN.	TYP.	MAX.	UNIT
Under Voltage Lockout Block						
ON Threshold Voltage	V_{T_ON}	$V^+ = L \rightarrow H$	5.6	5.9	6.2	V
OFF Threshold Voltage	V_{T_OFF}	$V^+ = H \rightarrow L$	5.4	5.7	6.0	V
Hysteresis Voltage	V_{HYS}		150	200	–	mV
Soft Start Block						
Soft Start Time	t_{SS}	$V_B=0.95V$	2	4	8	ms
Oscillator Block						
Oscillating Frequency	f_{OSC}	A version $V_{IN}=0.9V$, $V_{FB}=0.5V$	900	1,000	1,100	kHz
Oscillating Frequency OCP operates	f_{OSC_LIM}	$V_{IN}=0V$, $V_{FB}=0.5V$	–	333	–	kHz
Oscillating Frequency deviation (Supply voltage)	f_{DV}	$V^+=6.2V$ to $40V$	–	1	–	%
Oscillating Frequency deviation (Temperature)	f_{DT}	$T_a=-40^\circ C$ to $+85^\circ C$	–	5	–	%
Error Amplifier Block						
Reference Voltage	V_B		-1.0%	1.00	+1.0%	V
Input Bias Current	I_B		-0.1	–	0.1	μA
PWM Comparator Block						
Maximum Duty Cycle	$M_{AX}D_{UTY}$	$V_{IN}=0.9V$	100	–	–	%
Output Block						
Output ON Resistance	R_{ON}	$I_{SW}=300mA$	–	1.0	1.45	Ω
Switching Current Limit	I_{LIM}		450	600	750	mA
SW Leak Current	I_{LEAK}	$V_{ON/OFF}=0V$, $V^+=40V$, $V_{SW}=0V$	–	–	1	μA
ON/OFF Block						
ON Control Voltage	V_{ON}	$V_{ON/OFF}=L \rightarrow H$	1.6	–	V^+	V
OFF Control Voltage	V_{OFF}	$V_{ON/OFF}=H \rightarrow L$	0	–	0.3	V
General Characteristic						
Quiescent Current	I_{DD}	$R_L=no\ load$, $V_{IN}=0.9V$, $V_{FB}=0.5V$	–	2.75	3.1	mA
Standby Current	I_{DD_STB}	$V_{ON/OFF}=0V$	–	–	1	μA

■ TYPICAL APPLICATIONS

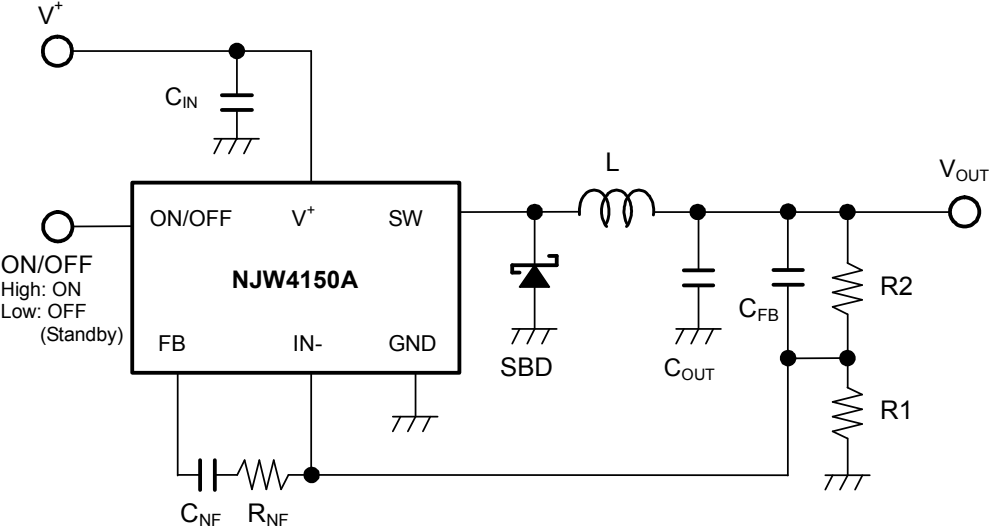

NJW4150A

TYPICAL CHARACTERISTICS

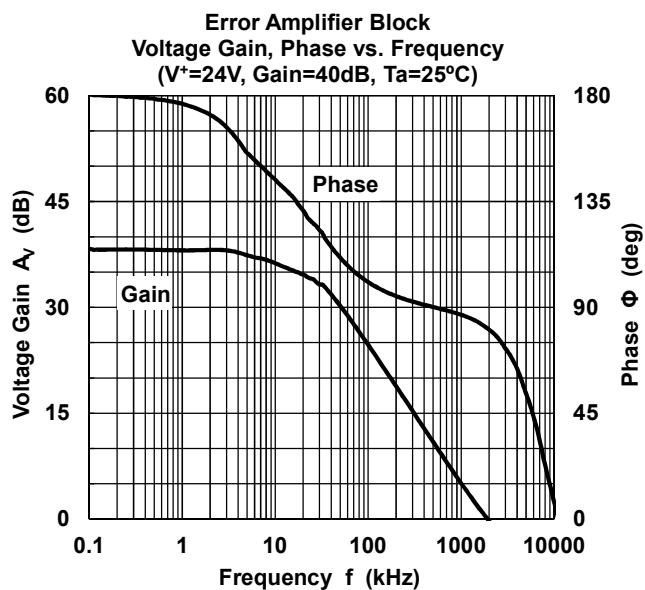
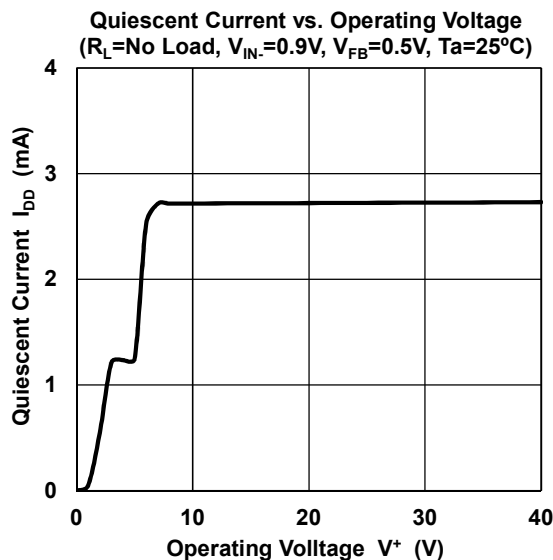
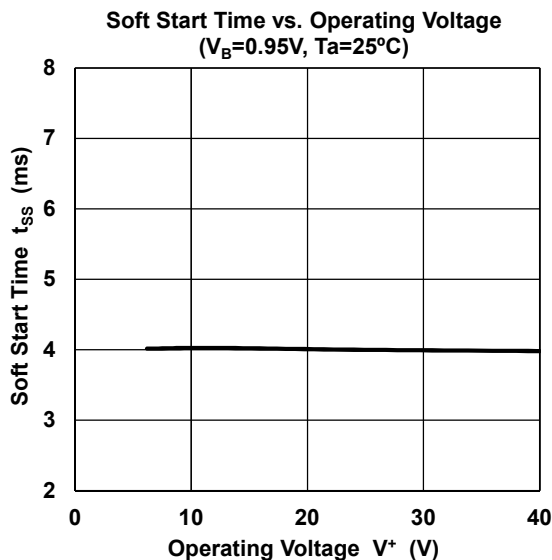
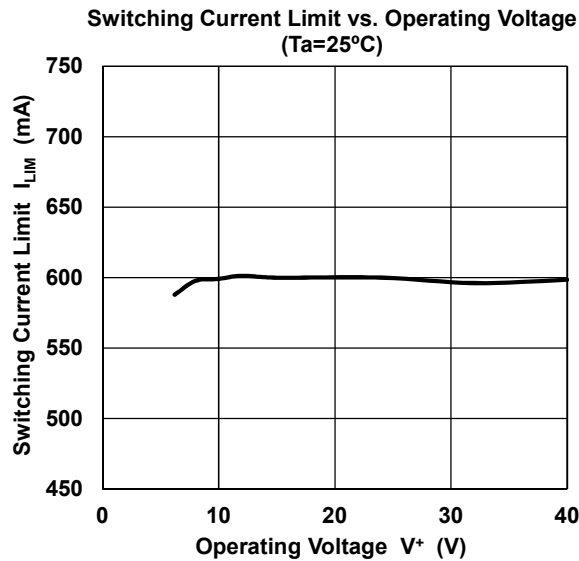
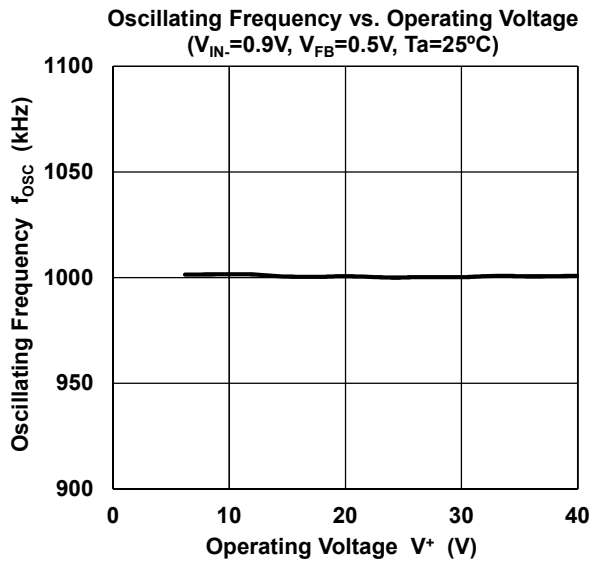

■ TYPICAL CHARACTERISTICS

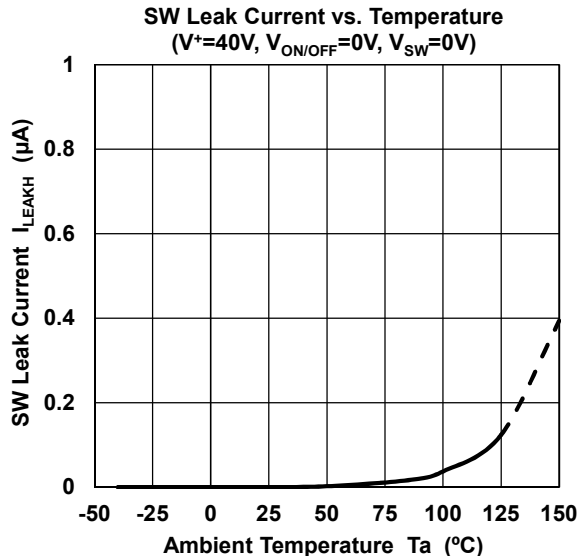
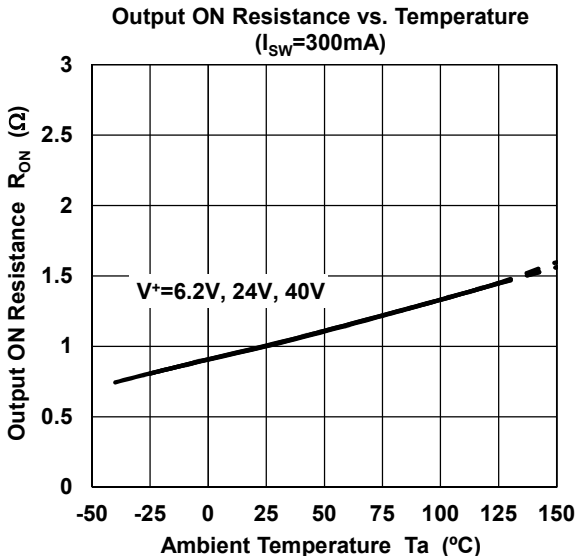
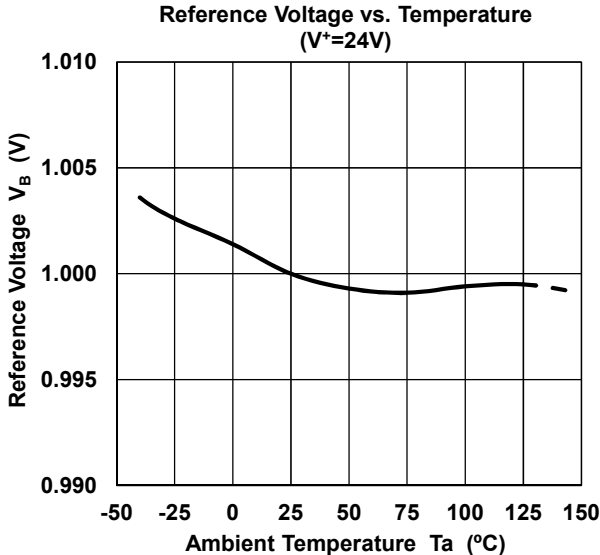
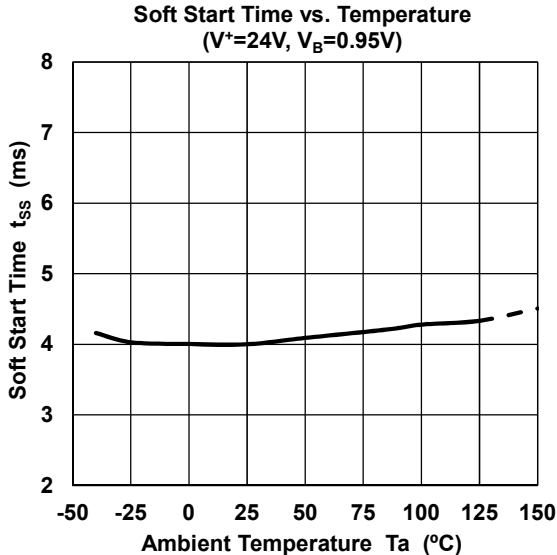
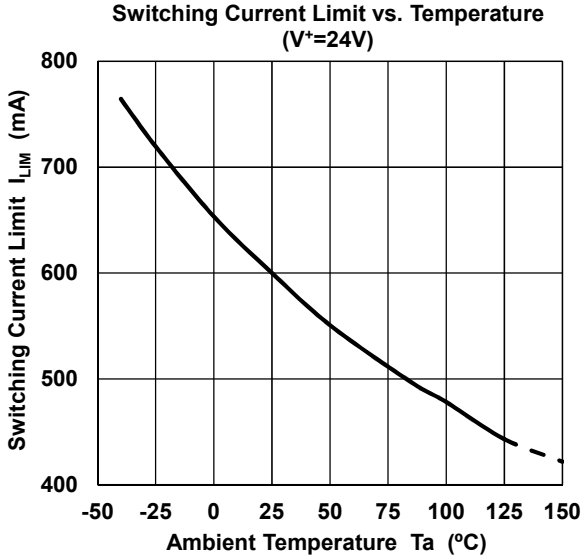
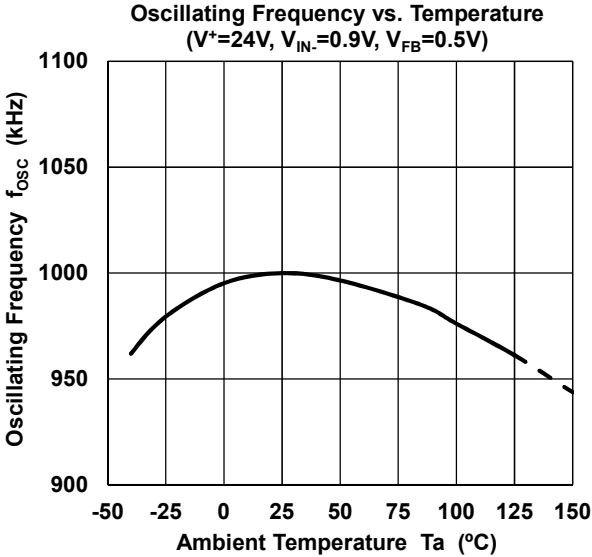

NJW4150A

■ TYPICAL CHARACTERISTICS

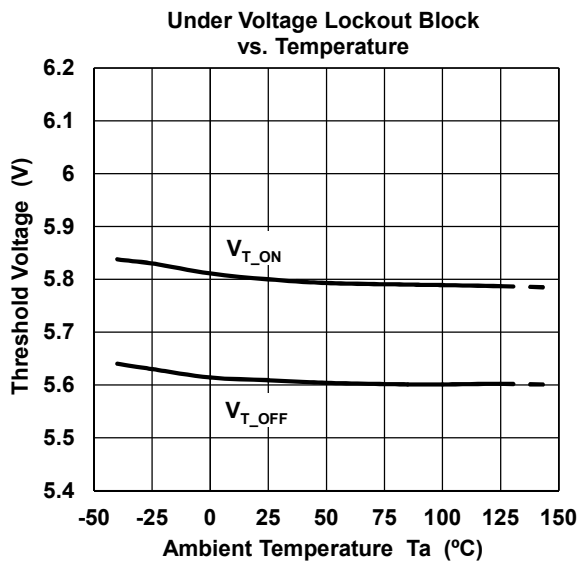
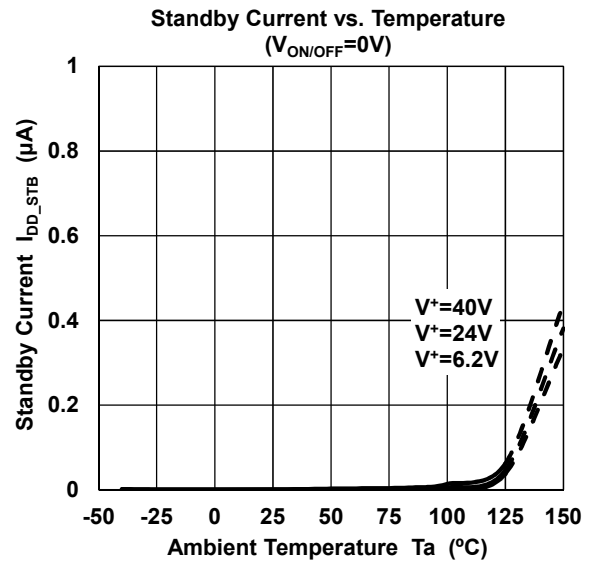
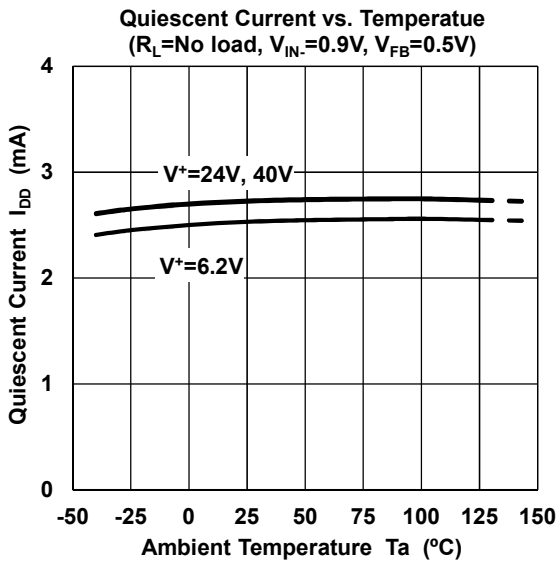

MEMO

[CAUTION]

The specifications on this databook are only given for information, without any guarantee as regards either mistakes or omissions. The application circuits in this databook are described only to show representative usages of the product and not intended for the guarantee or permission of any right including the industrial rights.