

LOW DROPOUT VOLTAGE REGULATOR

■ GENERAL DESCRIPTION

The NJU7790 is a 500mA output low dropout voltage regulator with ON/OFF control.

Advanced CMOS technology achieves high ripple rejection and low quiescent current.

Small packaging and 2.2 μ F small decoupling capacitor make the NJU7790 suitable for space conscious applications.

■ PACKAGE OUTLINE

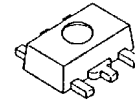

NJU7790U1

■ FEATURES

- High Ripple Rejection 65dB typ. (f=400Hz, Vo=3.0V version)
- Low quiescent Current Iq=30 μ A typ.(Io=0mA)
- Output Current Io(max.)=500mA
- High Precision Output Vo \pm 1.0%
- Output capacitor with 2.2 μ F ceramic capacitor (Vo \geq 2.1V version)
- Low Dropout Voltage 0.14V typ. (Io=300mA, Vo=3.0V version)
- ON/OFF Control
- Internal Thermal Overload Protection
- Internal Over Current Protection
- CMOS Technology
- Package Outline SOT-89-5

■ PIN CONFIGURATION

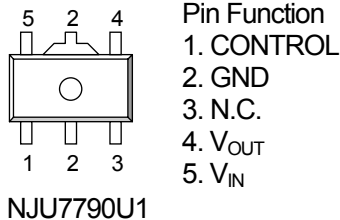

NJU7790U1

■ EQUIVALENT CIRCUIT

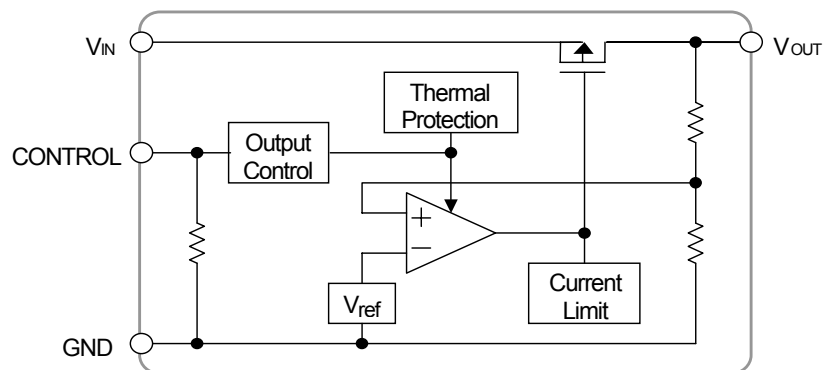

■ OUTPUT VOLTAGE RANK LIST

Device Name	V _{OUT}	Device Name	V _{OUT}
NJU7790U1-15	1.5V	NJU7790U1-33	3.3V
NJU7790U1-21	2.1V	NJU7790U1-05	5.0V
NJU7790U1-03	3.0V		

NJU7790

■ ABSOLUTE MAXIMUM RATINGS (Ta=25°C)

PARAMETER	SYMBOL	RATINGS	UNIT
Input Voltage	V _{IN}	+9	V
Control Voltage	V _{CONT}	+9(*1)	V
Power Dissipation	P _D	500(*2) 765(*3)	mW
Operating Temperature	Topr	-40~+85	°C
Storage Temperature	Tstg	-40~+125	°C

(*1): When input voltage is less than +10V, the absolute maximum control voltage is equal to the input voltage.

(*2): Mounted on glass epoxy board. (76.2 × 114.3 × 1.6mm:based on EIA/JDEC standard size, 2Layers, Cu area 100mm²)

(*3): Mounted on glass epoxy board. (76.2 × 114.3 × 1.6mm:based on EIA/JDEC standard, 4Layers)

(For 4Layers: Applying 74.2 × 74.2mm inner Cu area and a thermal via hole to a board based on JEDEC standard JESD51-5)

■ Operating voltage

V_{IN}=+2.3 ~ +8V (In case of Vo<2.1V version)

■ ELECTRICAL CHARACTERISTICS (V_{IN}=Vo+1V, C_{IN}=1.0μF, Co=2.2μF(Co=4.7μF: Vo<2.0V), Ta=25°C)

PARAMETER	SYMBOL	TEST CONDITION	MIN.	TYP.	MAX.	UNIT	
Output Voltage	Vo	Io=30mA	-1.0%	—	+1.0%	V	
Input Voltage	V _{IN}		—	—	8	V	
Quiescent Current	I _Q	Io=0mA, V _{CONT} =V _{IN} , Include I _{CONT}	—	30	60	μA	
Quiescent Current at Control OFF	I _{Q(OFF)}	V _{CONT} =0V	—	0.1	1.0	μA	
Output Current	Io	Vo - 0.1V (Vo<2.0V Version) Vo - 0.3V (Vo≥2.1V Version)	500	—	—	mA	
Short Current Limit	I _{LIM}	Vo=0V	—	180	—	mA	
Line Regulation	ΔVo/ΔV _{IN}	V _{IN} =Vo+1V ~ Vo+6.0V (Vo<2V Version) V _{IN} =Vo+1V ~ 8.0V (Vo≥2V Version), Io=30mA	—	—	0.15	%/V	
Load Regulation	ΔVo/ΔIo	Io=0 ~ 500mA	—	—	0.005	%/mA	
Dropout Voltage(*4)	ΔV _{LO}	Io=300mA	2.1V≤Vo<2.5V	—	0.17	0.22	V
			2.5V≤Vo<2.9V	—	0.15	0.19	V
			2.9V≤Vo<3.5V	—	0.14	0.18	V
			3.5V≤Vo<5.0V	—	0.12	0.16	V
Ripple Rejection	RR	ein=200mVrms, f=400Hz, Io=10mA, Vo=3V Version	—	65	—	dB	
Average Temperature Coefficient of Output Voltage	ΔVo/ΔTa	Ta=0 ~ +85°C, Io=10mA	—	±100	—	ppm/°C	
Output Noise Voltage	V _{NO}	f=10Hz ~ 80kHz, Io=10mA, Vo=3V Version	—	75	—	μVrms	
Pull-down Resistance	R _{CONT}		2	5	10	MΩ	
Control Voltage for ON-state	V _{CONT(ON)}		1.6	—	—	V	
Control Voltage for OFF-state	V _{CONT(OFF)}		—	—	0.3	V	

(*4): Except output voltage less than 2.1V.

The above specification is a common specification for all output voltages.

Therefore, it may be different from the individual specification for a specific output voltage.

■ TEST CIRCUIT

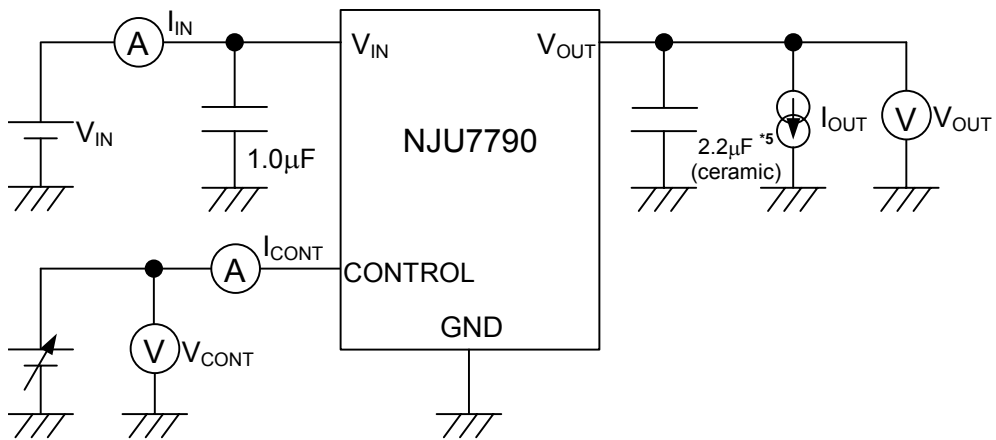

*5 $V_o \leq 2.0V$ version: $C_o = 4.7\mu F$ (ceramic)

■ TYPICAL APPLICATION

① In case that ON/OFF Control is not required:

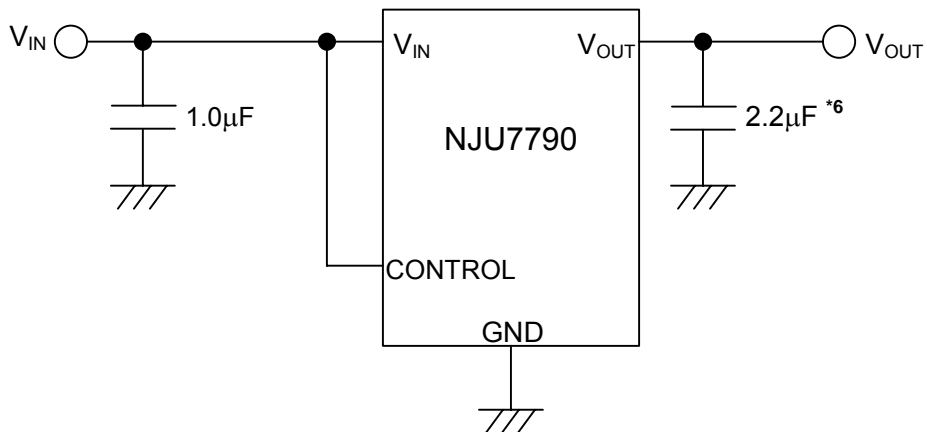

*6: $V_o \leq 2.0V$ version: $C_o = 4.7\mu F$

Connect control pin to V_{IN} pin.

② In use of ON/OFF Control

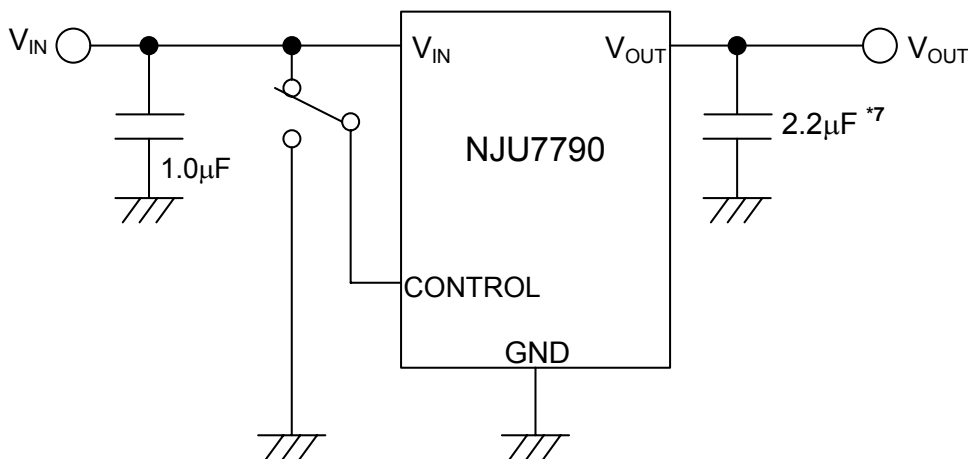

*7: $V_O \leq 2.0V$ version: $C_O = 4.7\mu F$

State of control pin:

- "H" → output is enabled.
- "L" or "open" → output is disabled.

*In the case of using a resistance "R" between V_{IN} and control.

If this resistor is inserted, it can reduce the control current when the control voltage is high.

The applied voltage to control pin should set to consider voltage drop through the resistor "R" and the minimum control voltage for ON-state.

The $V_{CONT(ON)}$ and I_{CONT} have temperature dependence as shown in the "Control Current vs. Temperature" and "Control Voltage vs. Temperature" characteristics. Therefore, the resistance "R" should be selected to consider the temperature characteristics.

*Output Capacitor C_O

Output capacitor (C_O) will be required for a phase compensation of the internal error amplifier.

The capacitance and the equivalent series resistance (ESR) influence to stable operation of the regulator.

Use of a smaller C_O may cause excess output noise or oscillation of the regulator due to lack of the phase compensation.

On the other hand, Use of a larger C_O reduces output noise and ripple output, and also improves output transient response when rapid load change.

Therefore, use the recommended C_O value (refer to conditions of ELECTRIC CHARACTERISTIC) or larger and should connect between GND and V_{OUT} as shortest path as possible for stable operation

The recommended capacitance depends on the output voltage rank. Especially, low voltage regulator requires larger C_O value.

In addition, you should consider varied characteristics of capacitor (a frequency characteristic, a temperature characteristic, a DC bias characteristic and so on) and unevenness peculiar to a capacitor supplier enough.

When selecting C_O , recommend that have withstand voltage margin against output voltage and superior temperature characteristic though this product is designed stability works with wide range ESR of capacitor including low ESR products.

TYPICAL CHARACTERISTICS

DC CHARACTERISTICS

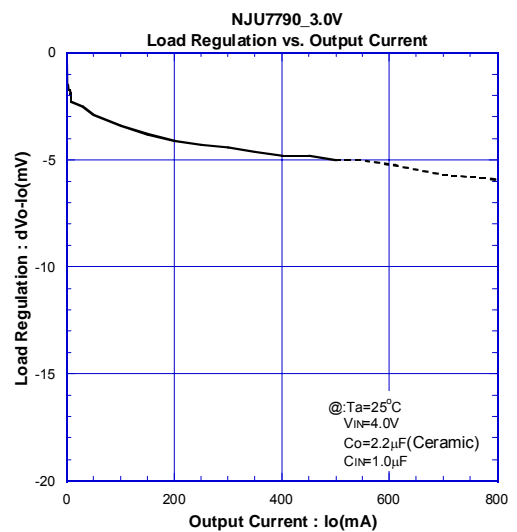
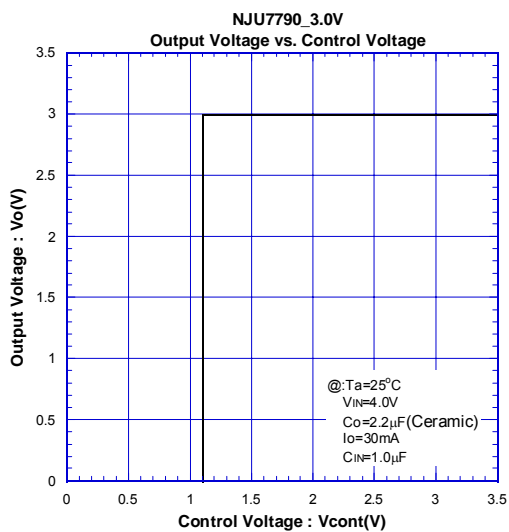
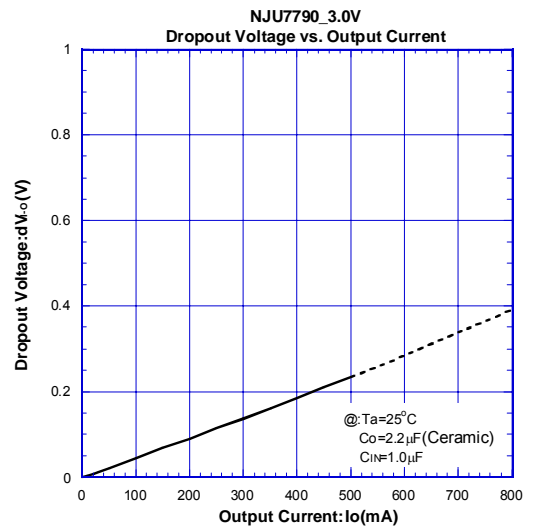
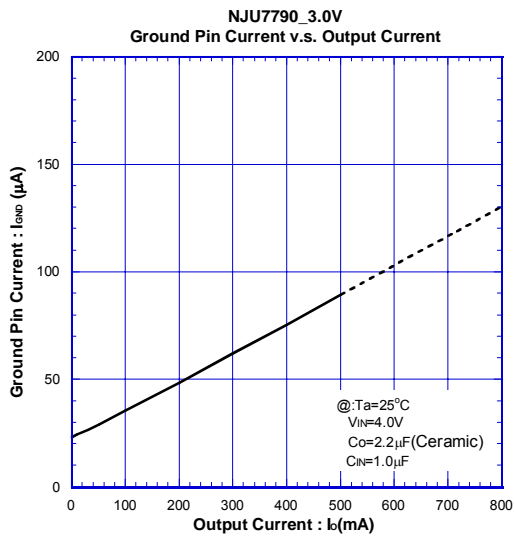
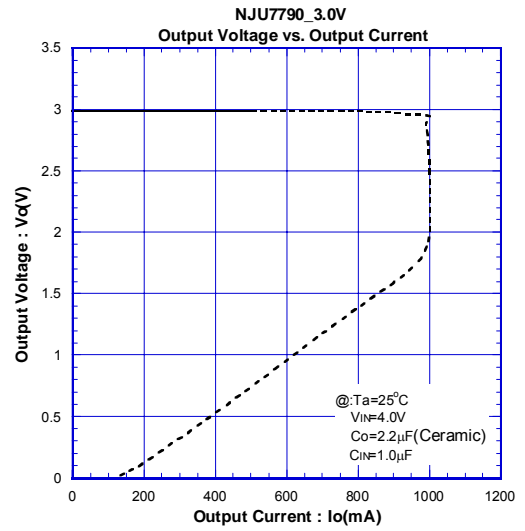
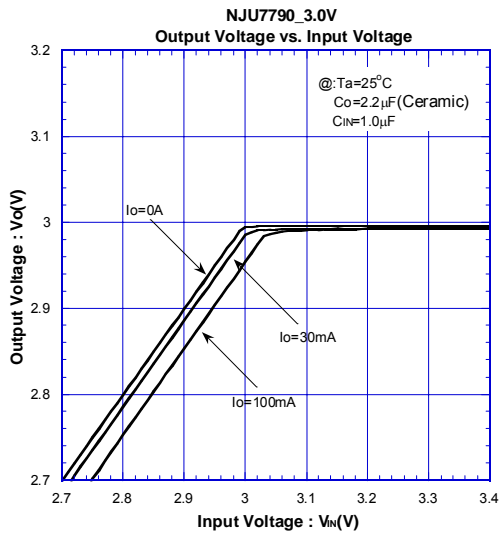

■ TYPICAL CHARACTERISTICS

● DC CHARACTERISTICS

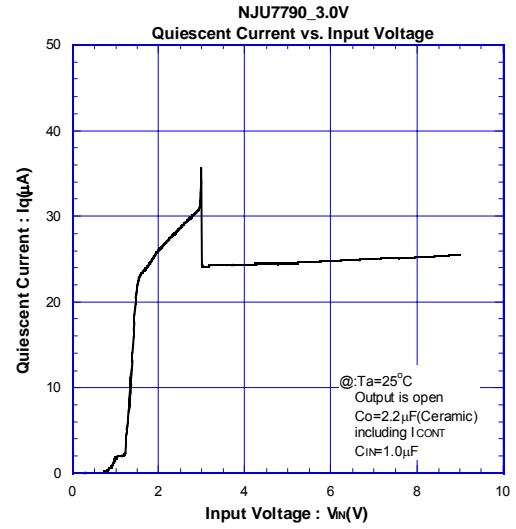
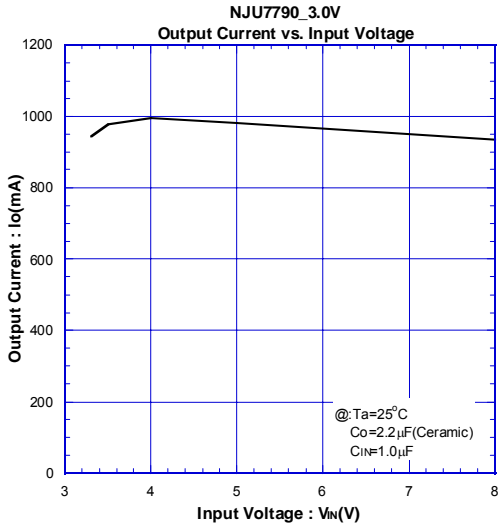

● AC CHARACTERISTICS

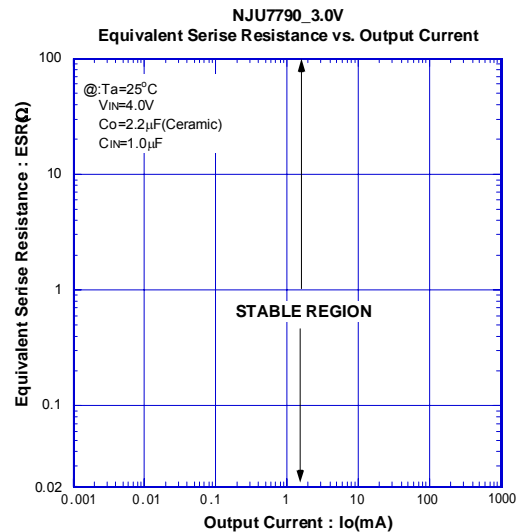
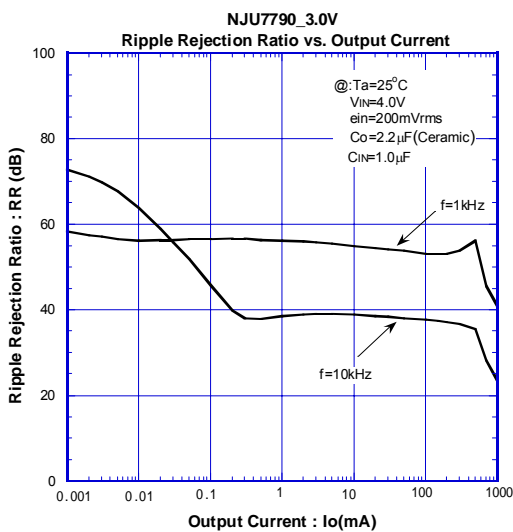
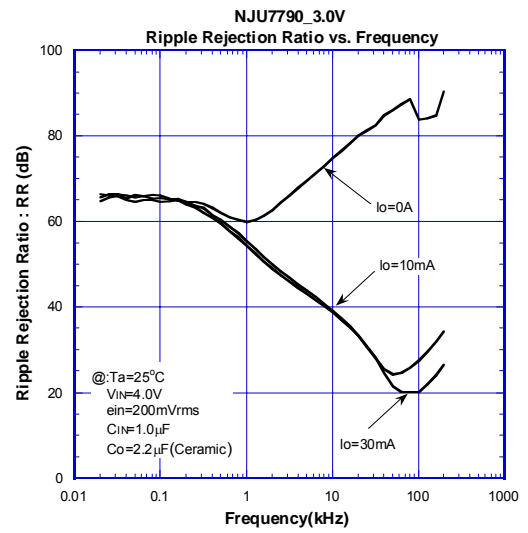
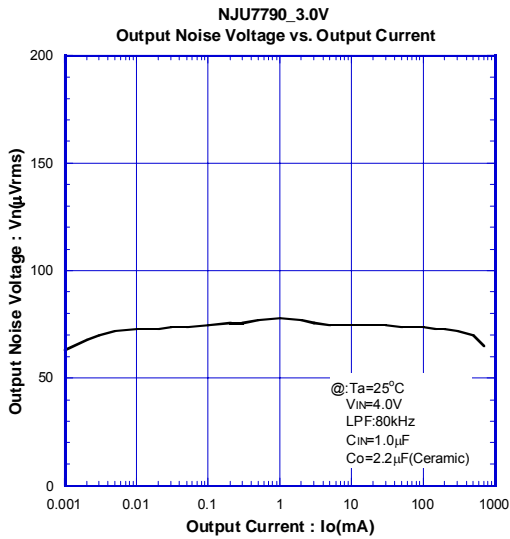

■ TYPICAL CHARACTERISTICS

● TEMPERATURE CHARACTERISTICS

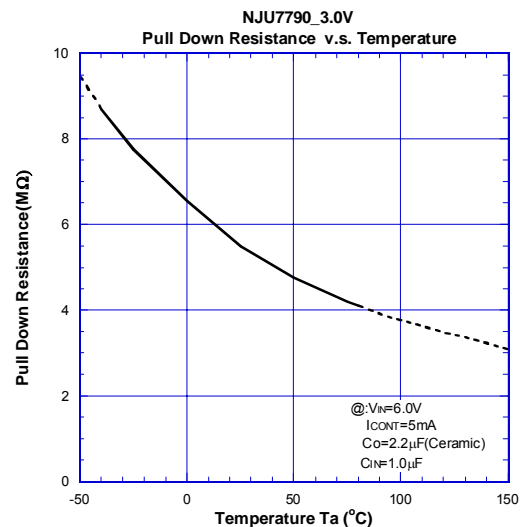
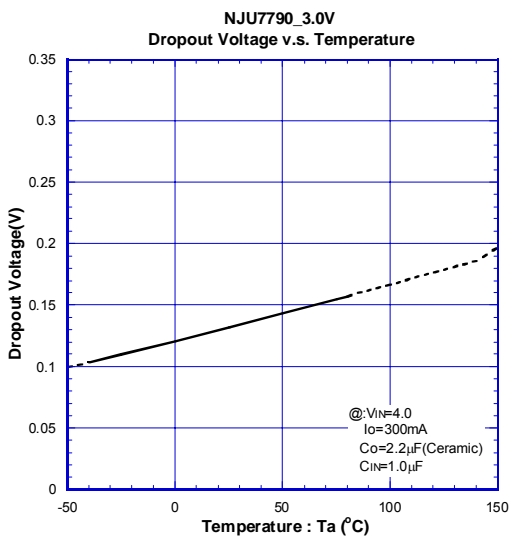
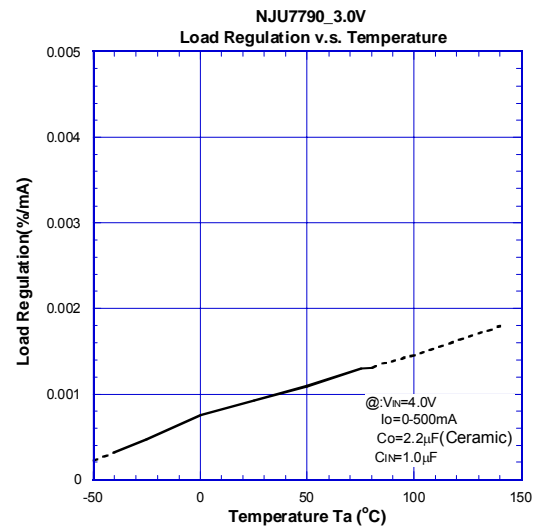
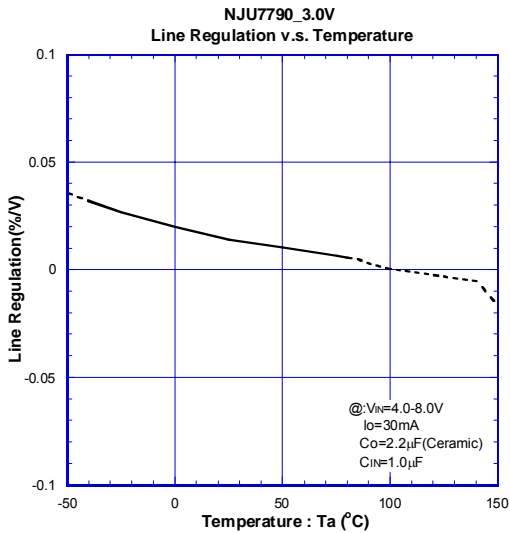
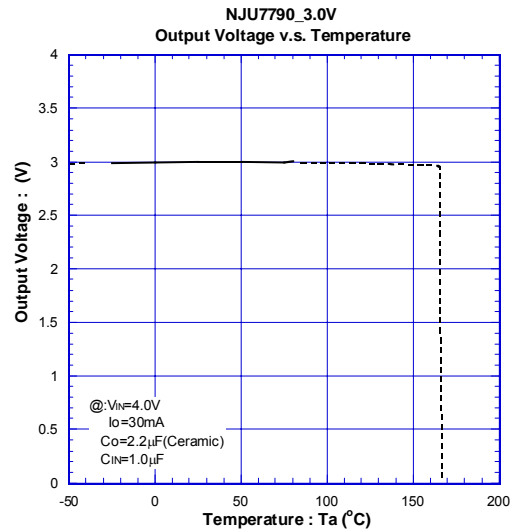
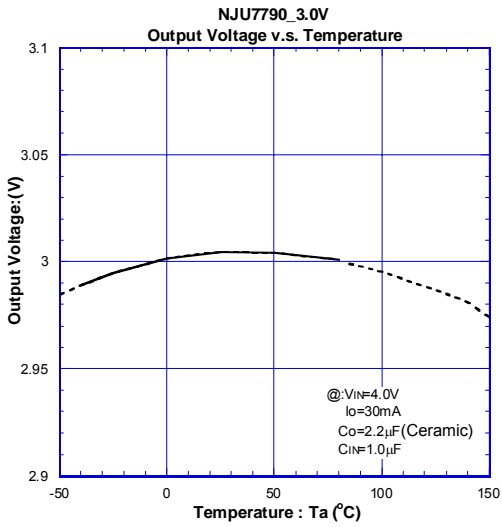

■ TYPICAL CHARACTERISTICS

● TEMPERATURE CHARACTERISTICS

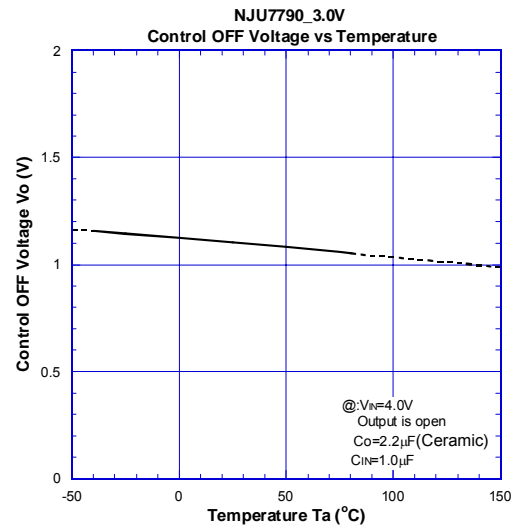
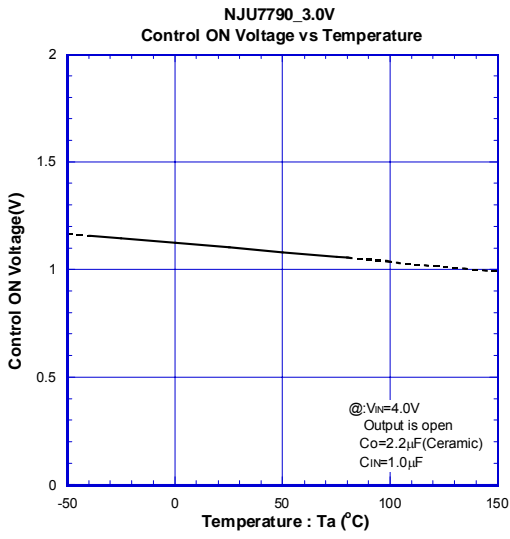

■ TYPICAL CHARACTERISTICS

● TRANSIENT RESPONSE

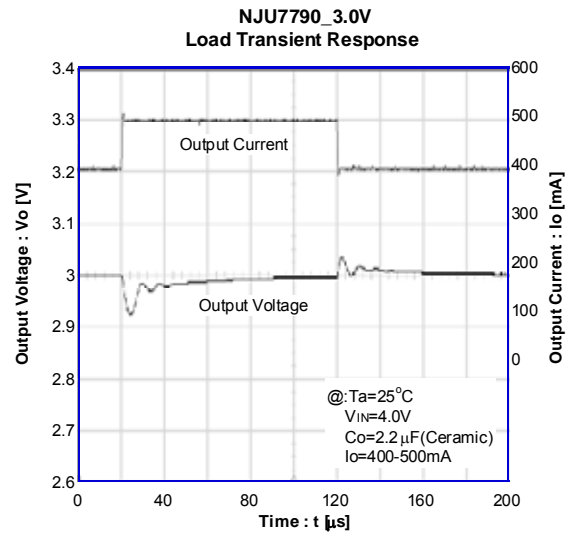
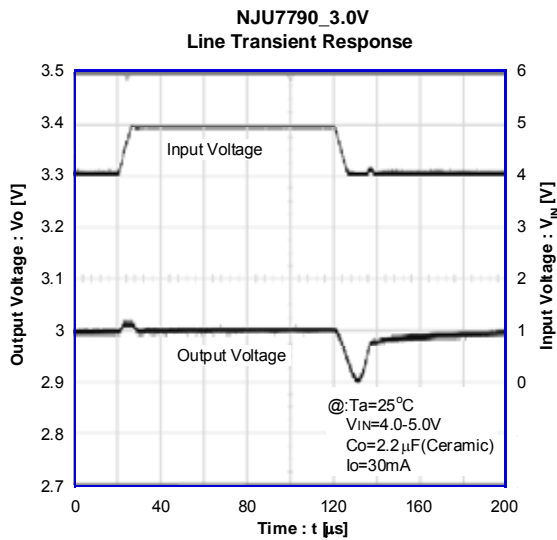
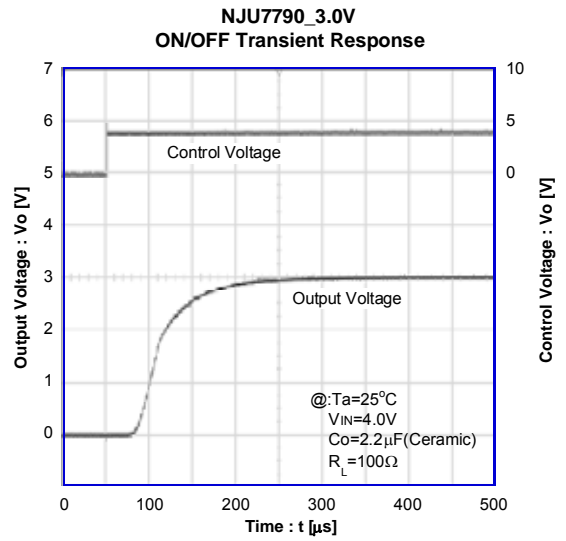
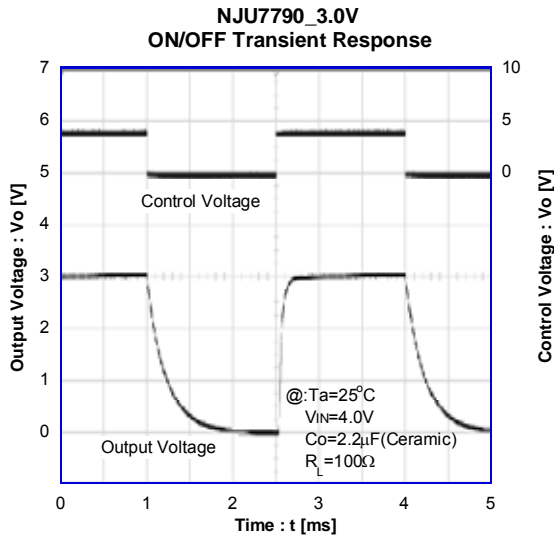

[CAUTION]
The specifications on this databook are only given for information, without any guarantee as regards either mistakes or omissions. The application circuits in this databook are described only to show representative usages of the product and not intended for the guarantee or permission of any right including the industrial rights.