

300mA Synchronous Step-Down switching regulator IC

■ GENERAL DESCRIPTION

The **NJU7691** is a synchronous rectification switching regulator IC with a power MOSFET (300mA output).

It incorporates an over-current detection and thermal shutdown circuit, which can make a power supply circuit with few external parts. The output voltage can be set from 1.8V. Therefore it is suitable for a power supply circuit for digital chips and logic ICs. The NJU7691 is available in a small and thin 8-lead MSOP (TVSP) package.

■ PACKAGE OUTLINE

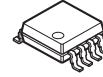

NJU7691RB1
(MSOP8 (TVSP8))

■ FEATURES

- 300mA Synchronous Step-Down
- PWM switching control
- Operating Voltage 2.2V to 7V
- Wide Oscillator Range 300kHz to 1MHz
- Maximum Duty Cycle 100%
- Stand-by Current 5 μ A max.
- Soft-Start Function 4ms typ.
- Over Current Protection
- C-MOS Technology
- Package Outline NJU7691RB1 : MSOP8 (TVSP8)*

*MEET JEDEC MO-187-DA / THIN TYPE

■ PIN CONFIGURATION

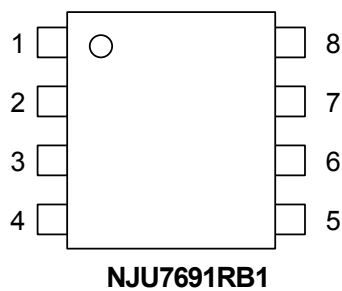

PIN FUNCTION

1. SW
2. V⁺
3. FB
4. IN-
5. ON/OFF
6. RT
7. AGND
8. PGND

■ ABSOLUTE MAXIMUM RATINGS

(Ta=25°C)

PARAMETER	SYMBOL	MAXIMUM RATINGS	UNIT
Supply Voltage	V ⁺	+8	V
ON/OFF pin Voltage	V _{ON/OFF}	+8	V
Power Dissipation	P _D	580 (*1)	mW
Operating Temperature Range	T _{opr}	-40 to +85	°C
Storage Temperature Range	T _{stg}	-40 to +150	°C

(*1): Mounted on glass epoxy board based on EIA/JEDEC. (76.2 × 114.3 × 1.6mm: 2-Layers)

■ RECOMMENDED OPERATING CONDITIONS

PARAMETER	SYMBOL	MIN.	TYP.	MAX.	UNIT
Operating Voltage	V ⁺	2.2	–	7	V
Output Current (*2)	I _{OUT}	–	–	300	mA
Oscillator Timing Resistor	R _T	30	47	120	kΩ
Oscillation Frequency	f _{OSC}	300	700	1,000	kHz

(*2): Steady Operating

■ ELECTRICAL CHARACTERISTICS

(V⁺=V_{ON/OFF}=3.3V, R_T=47kΩ, Ta=25°C)

PARAMETER	SYMBOL	TEST CONDITION	MIN.	TYP.	MAX.	UNIT
Under Voltage Lockout Block						
ON Threshold Voltage	V _{T_ON}	V ⁺ =L → H	1.9	2.0	2.1	V
OFF Threshold Voltage	V _{T_OFF}	V ⁺ =H → L	1.8	1.9	2.0	V
Hysteresis Voltage	V _{HYS}		60	100	–	mV
Soft Start Block						
Soft Start Time	T _{SS}	V _{T_ON} → Duty=80%	2	4	8	ms
Oscillator Block						
Oscillation Frequency	f _{OSC}		630	700	770	kHz
Oscillate Supply Voltage Fluctuations	f _{DV}	V ⁺ =2.2V to 7V	–	1	–	%
Oscillate Temperature Fluctuations	f _{DT}	Ta=-40°C to +85°C	–	3	–	%
Error Amplifier Block						
Reference Voltage	V _B		-1.0%	0.8	+1.0%	V
Input Bias Current	I _B		-0.1	–	0.1	μA
Open Loop Gain	A _V		–	80	–	dB
Gain Bandwidth Product	G _B		–	1	–	MHz
Output Source Current	I _{OM+}	V _{FB} =1V, V _{IN} =0.7V	20	35	50	μA
Output Sink Current	I _{OM-}	V _{FB} =1V, V _{IN} =0.9V	1	2.5	5	mA

NJU7691

■ ELECTRICAL CHARACTERISTICS

($V^+ = V_{ON/OFF} = 3.3V$, $R_T = 47k\Omega$, $T_a = 25^\circ C$)

PARAMETER	SYMBOL	TEST CONDITION	MIN.	TYP.	MAX.	UNIT
-----------	--------	----------------	------	------	------	------

PWM Compare Block

Input Threshold Voltage	$V_{T,0}$	Duty=0%	0.16	0.22	0.28	V
	$V_{T,50}$	Duty=50%	0.44	0.50	0.56	V
Maximum Duty Cycle	$M_{AX}D_{UTY}$	$V_{FB} = 0.9V$	100	—	—	%

Output Block

Output High Level ON Resistance	R_{OH}	$I_{SW} = -200mA$	—	0.9	1.2	Ω
Output Low Level ON Resistance	R_{OL}	$I_{SW} = +200mA$	—	0.8	1.1	Ω
Switching Current Limit	I_{LIM}		500	650	800	mA
High Side SW Leak Current	I_{LEAKH}	$V_{ON/OFF} = 0V$	—	—	1	μA
Output Pull-Down Resistance	R_{PD-SW}		60	100	140	$k\Omega$

ON/OFF Block

ON Control Voltage	V_{ON}	$V_{ON/OFF} = L \rightarrow H$	1.6	—	V^+	V
OFF Control Voltage	V_{OFF}	$V_{ON/OFF} = H \rightarrow L$	0	—	0.3	V

General Characteristics

Quiescent Current	I_{DD}	$R_L = \text{Non Load}$	—	1.3	1.6	mA
Standby Current	I_{DD_STB}	$V_{ON/OFF} = 0V$	—	—	5	μA

■ TYPICAL APPLICATIONS

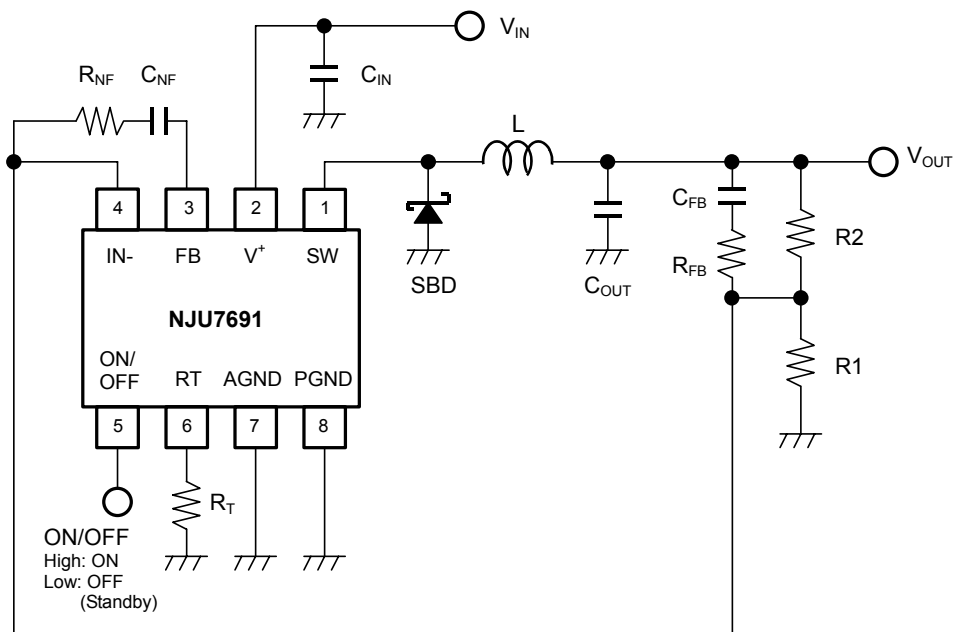

■ TYPICAL CHARACTERISTICS

Oscillation Frequency vs. Timing Resistance

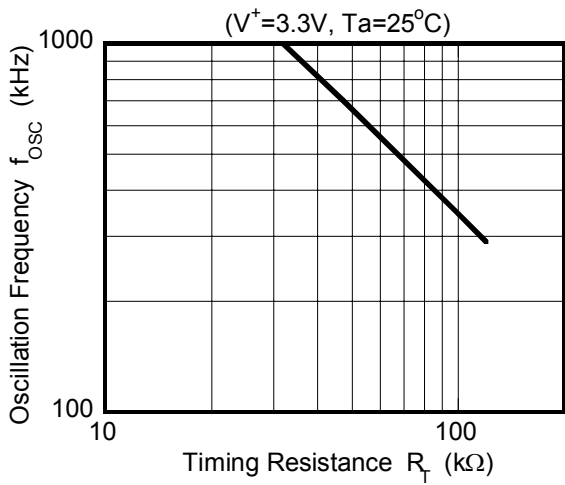

Oscillation Frequency vs. Operating Voltage

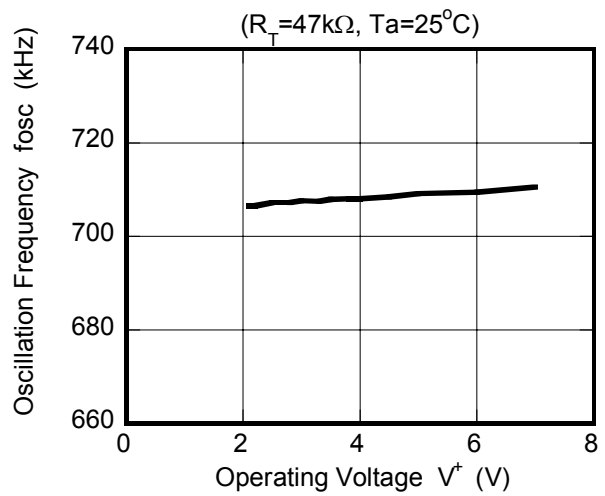

Reference Voltage vs. Operating Voltage

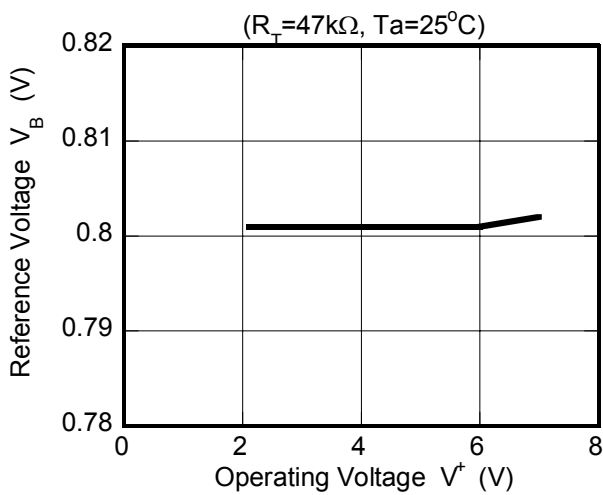

Switching Current Limit vs. Operating Voltage

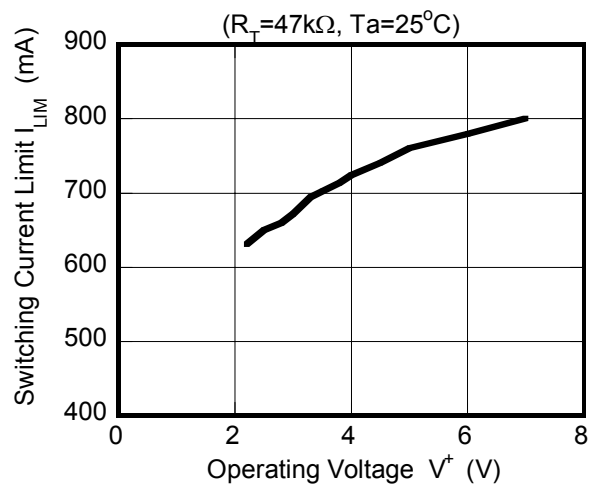

Quiescent Current vs. Operating Voltage

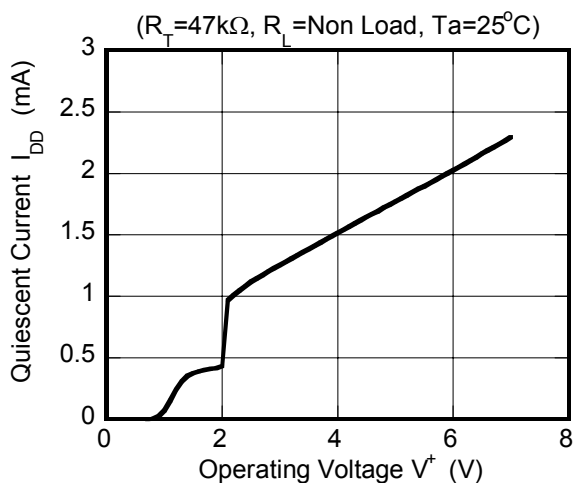

Standby Current vs. Operating Voltage

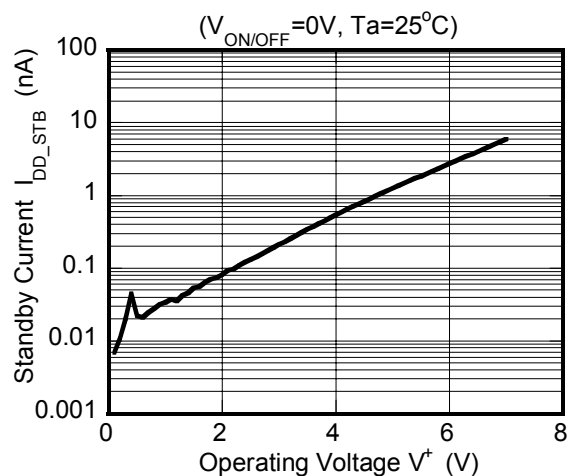

■ TYPICAL CHARACTERISTICS

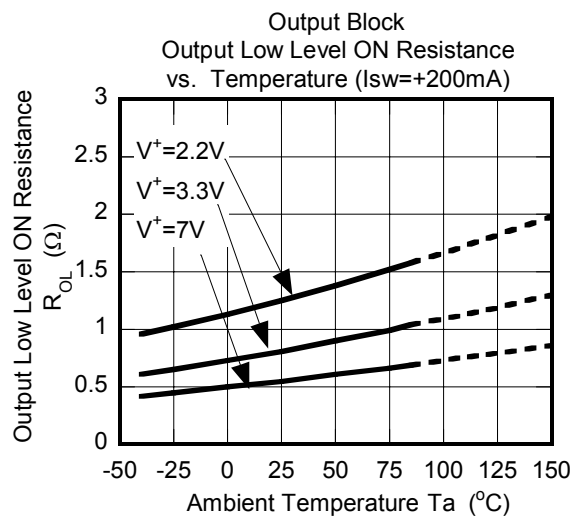
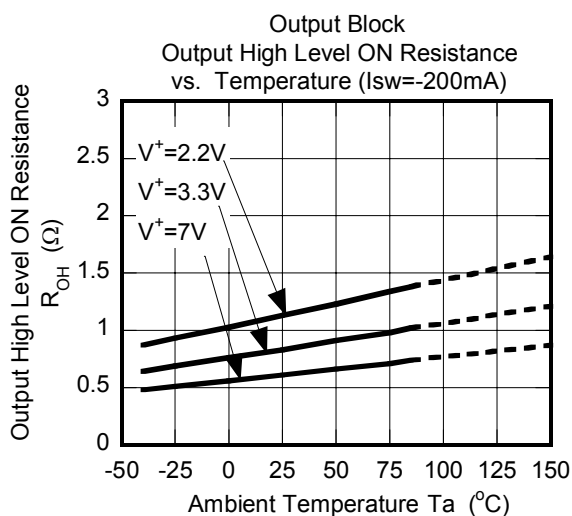
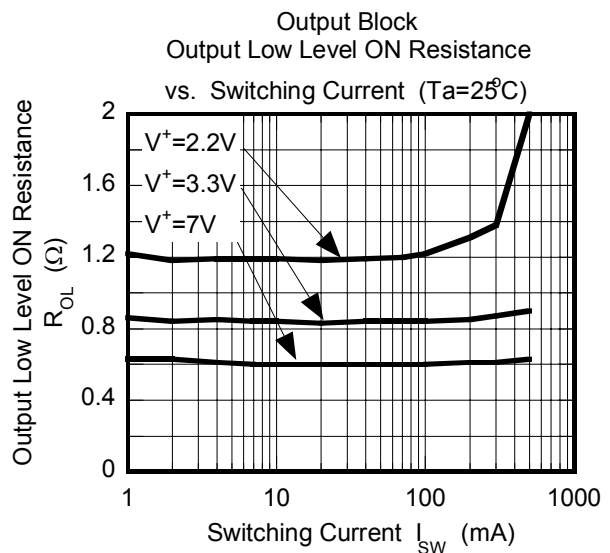
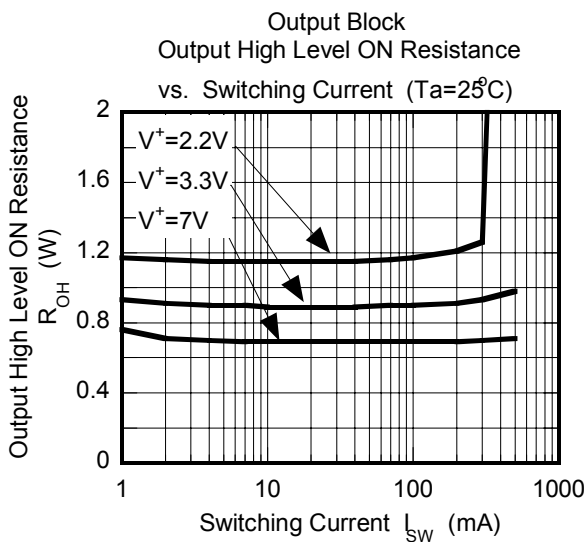
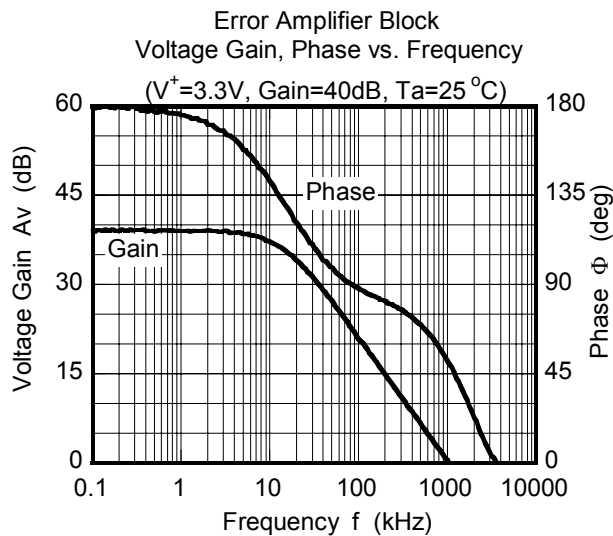

■ TYPICAL CHARACTERISTICS

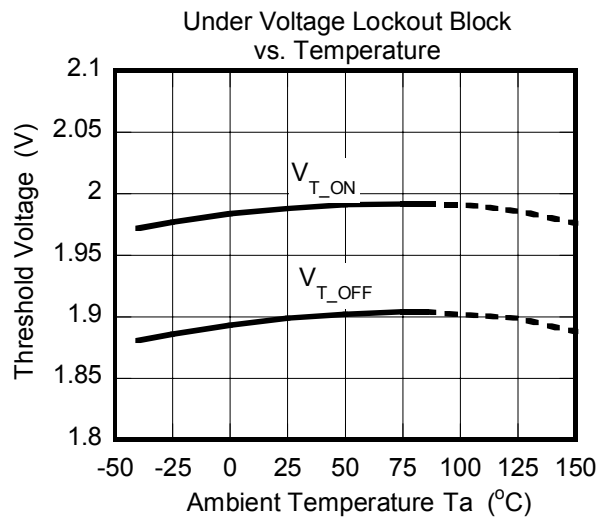
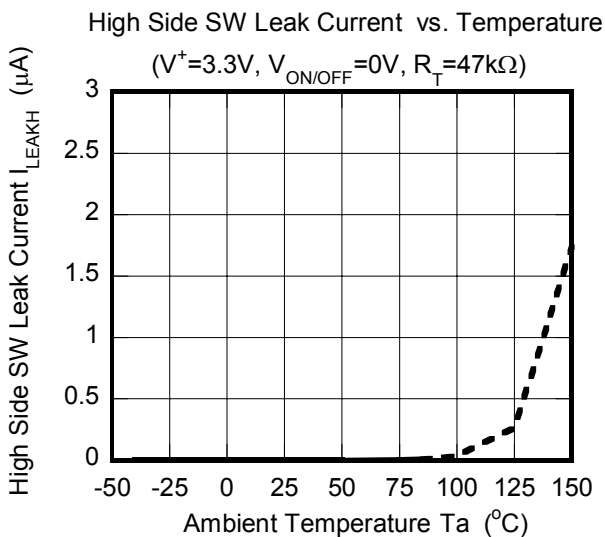
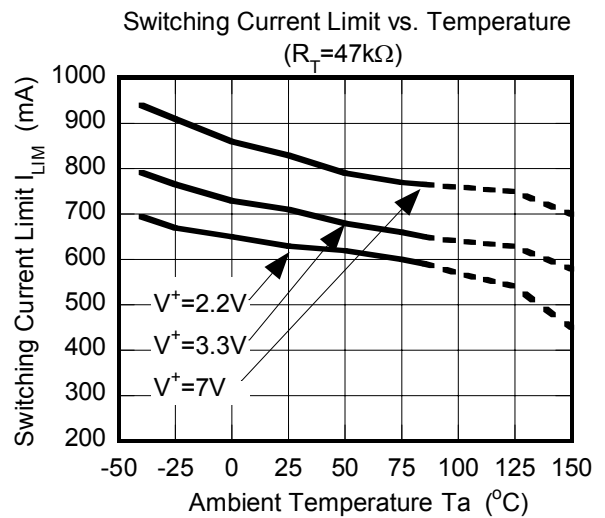
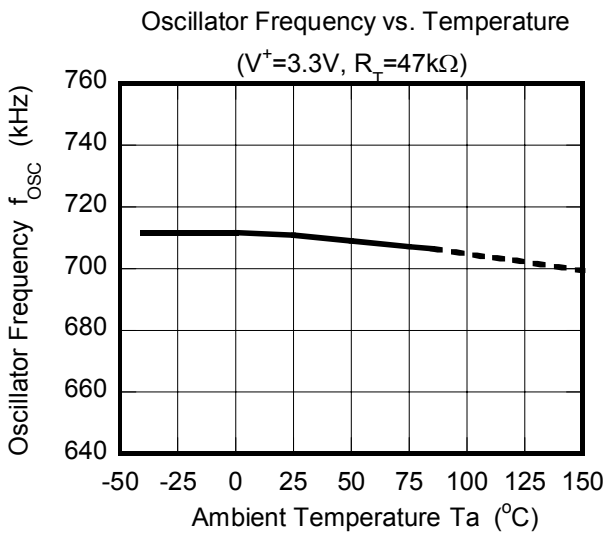
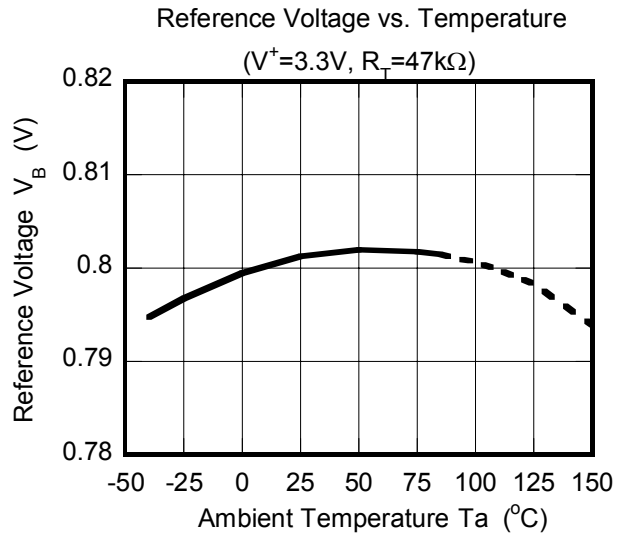
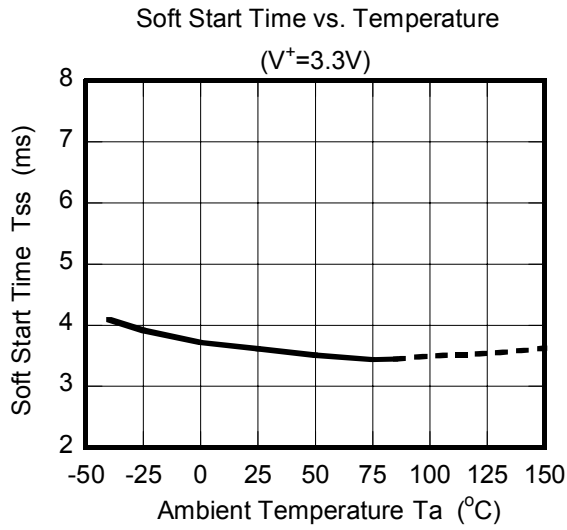

■ TYPICAL CHARACTERISTICS

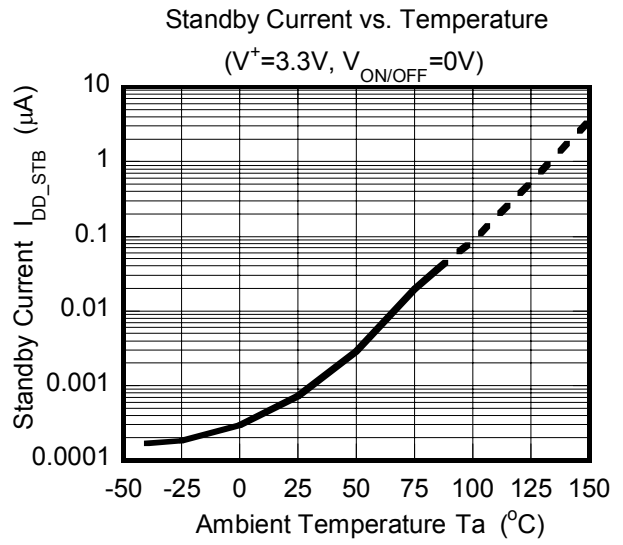
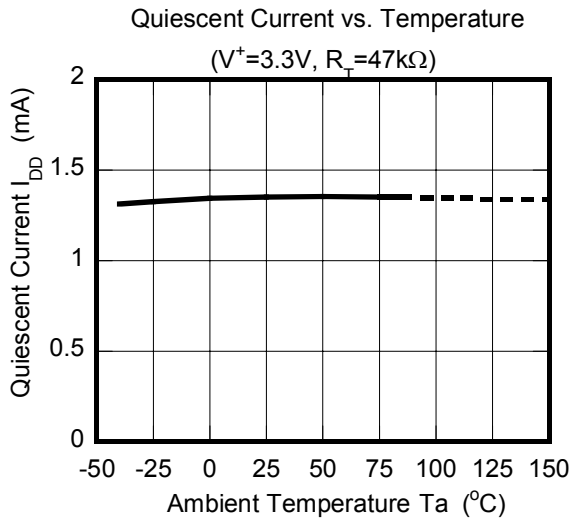

[CAUTION]
The specifications on this databook are only given for information, without any guarantee as regards either mistakes or omissions. The application circuits in this databook are described only to show representative usages of the product and not intended for the guarantee or permission of any right including the industrial rights.