

High Efficiency Synchronous Step-Down switching regulator IC

■ GENERAL DESCRIPTION

The **NJU7690** is a high efficiency synchronous step-down switching regulator control IC. It offers high efficiency power supply circuits in applications by synchronous rectification. The NJU7690 also has a soft-start function, dead time control and timer latch for short circuit protection and their times are all adjustable with external parts. It is available in a small and thin 10-lead MSOP (TVSP) package. It is suitable for battery powered applications.

■ PACKAGE OUTLINE



NJU7690RB2
(MSOP10 (TVSP10))

■ FEATURES

- Synchronous Rectification
- PWM switching control
- Standby Function
- Operating Voltage 2.2V to 8V
- Wide Oscillator Range 300kHz to 1MHz
- Maximum Duty Cycle 100%
- Quiescent Current Operating :800 μ A typ.
 Standby :1 μ A max.
- Soft-Start Function Internal : 16ms typ. or adjustable
- Dead Time Control
- Timer Latch for Short Circuit Protection
- C-MOS Technology
- Package Outline NJU7690RB2 : TVSP10

■ PRODUCT VARIATION

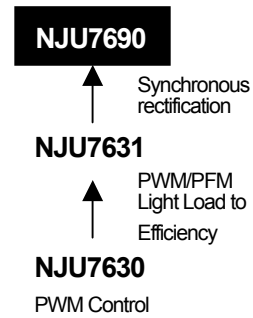

■ PIN CONFIGURATION

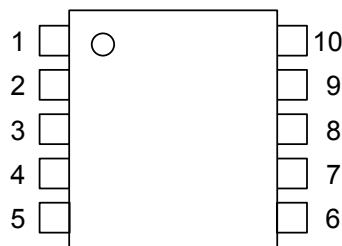

NJU7690RB2

PIN FUNCTION

1. OUTP
2. V⁺
3. FB
4. IN-
5. SCP
6. ON/OFF
7. DTC
8. RT
9. GND
10. OUTN

NJU7690

■ BLOCK DIAGRAM

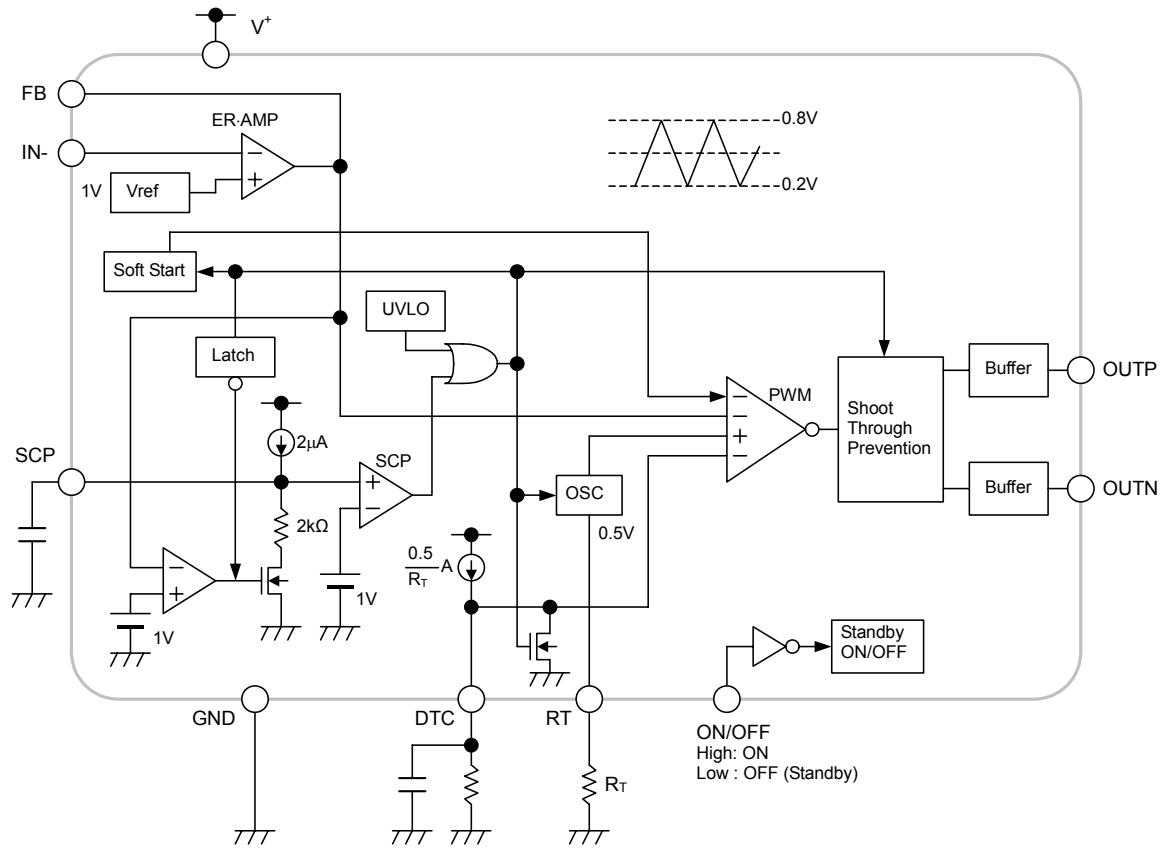

■ ABSOLUTE MAXIMUM RATINGS

(Ta=25°C)

PARAMETER	SYMBOL	MAXIMUM RATINGS	UNIT
Supply Voltage	V ⁺	+9	V
Output Pin Current	I _O	±50	mA
Power Dissipation	P _D	MSOP8 (TVSP8) :320	mW
Operating Temperature Range	T _{OPR}	-40 to +85	°C
Storage Temperature Range	T _{STG}	-40 to +125	°C

■ RECOMMENDED OPERATING CONDITIONS

(Ta=25°C)

PARAMETER	SYMBOL	MIN.	TYP.	MAX.	UNIT
Operating Voltage	V ⁺	2.2	–	8	V
Oscillator Timing Resistor	R _T	30	47	120	kΩ
Oscillation Frequency	f _{OSC}	300	700	1,000	kHz

■ ELECTRICAL CHARACTERISTICS

(V⁺ = V_{ON/OFF} = 3.3V, R_T = 47kΩ, Ta = 25°C)

PARAMETER	SYMBOL	TEST CONDITION	MIN.	TYP.	MAX.	UNIT
Under Voltage Lockout Block						
ON Threshold Voltage	V _{T_ON}	V ⁺ = L → H	1.9	2.0	2.1	V
OFF Threshold Voltage	V _{T_OFF}	V ⁺ = H → L	1.8	1.9	2.0	V
Hysteresis Voltage	V _{HYS}		60	100	–	mV
Soft Start Block						
Soft Start Time	T _{SS}	V _{T_ON} → Duty=80%	8	16	24	ms
Short Circuit Protection Block						
Input Threshold Voltage	V _{T_PC}	FB Pin	0.95	1.00	1.05	V
Charge Current	I _{CHG}	V _{SCP} = 0V	1.5	2	2.5	μA
Latch Mode ON Threshold Voltage	V _{T_LA}	SCP Pin	0.95	1.00	1.05	V
Latch Mode OFF Threshold Voltage	V _{T_LAOFF}	SCP Pin	0.20	0.45	0.70	V
Oscillator Block						
RT Pin Voltage	V _{RT}		-10%	0.5	+10%	V
Oscillation Frequency	f _{OSC}		630	700	770	kHz
Oscillate Supply Voltage Fluctuations	f _{DV}	V ⁺ = 2.2V to 8V	–	1	–	%
Oscillate Temperature Fluctuations	f _{DT}	Ta = -40°C to +85°C	–	3	–	%

NJU7690

■ ELECTRICAL CHARACTERISTICS

($V^+ = V_{ON/OFF} = 3.3V$, $R_T = 47k\Omega$, $T_a = 25^\circ C$)

PARAMETER	SYMBOL	TEST CONDITION	MIN.	TYP.	MAX.	UNIT
-----------	--------	----------------	------	------	------	------

Error Amplifier Block

Reference Voltage	V_B		-1.0%	1.00	+1.0%	V
Input Bias Current	I_B		-0.1	—	0.1	μA
Open Loop Gain	A_V		—	80	—	dB
Gain Bandwidth Product	G_B		—	1	—	MHz
Output Source Current	I_{OM+1}	$V_{FB} = 1V, V_{IN-} = 0.9V$	12	40	70	mA
	I_{OM+2}	$V_{FB} = 1V, V_{IN-} = 0.9V, V^+ = 2.2V$	2.5	9	16	mA
Output Sink Current	I_{OM-}	$V_{FB} = 1V, V_{IN-} = 1.1V$	0.10	0.16	0.22	mA

PWM Compare Block

Input Threshold Voltage	V_{T0}	Duty=0%	0.10	0.16	0.22	V
	V_{T50}	Duty=50%	0.4	0.5	0.6	V
Maximum Duty Cycle	$M_{AXDUTY1}$	$V_{FB} = 0.9V$	100	—	—	%
	$M_{AXDUTY2}$	$V_{FB} = 0.9V, R_{DTC} = 47k\Omega$	35	50	65	%

Output Block

OUTP Output High Level ON Resistance	R_{OPH}	$I_O = -20mA$	—	10	20	Ω
OUTP Output Low Level ON Resistance	R_{OPL}	$I_O = +20mA$	—	5	10	Ω
OUTN Output High Level ON Resistance	R_{ONH}	$I_O = -20mA$	—	10	20	Ω
OUTN Output Low Level ON Resistance	R_{ONL}	$I_O = +20mA$	—	5	10	Ω
OUTP-OUTN Rise Dead Time	t_{dr}		55	85	120	ns
OUTN-OUTP Fall Dead Time	t_{df}		45	75	110	ns

ON/OFF Block

ON Control Voltage	V_{ON}	$V_{ON/OFF} = L \rightarrow H$	1.6	—	V^+	V
OFF Control Voltage	V_{OFF}	$V_{ON/OFF} = H \rightarrow L$	0	—	0.3	V

General Characteristics

Quiescent Current	I_{DD}	$R_L = \text{Non Load}$	—	800	1200	μA
Standby Current	I_{DD_STB}	$V_{ON/OFF} = 0V$	—	—	1.0	μA

■ TYPICAL APPLICATIONS

Step-Down Converter

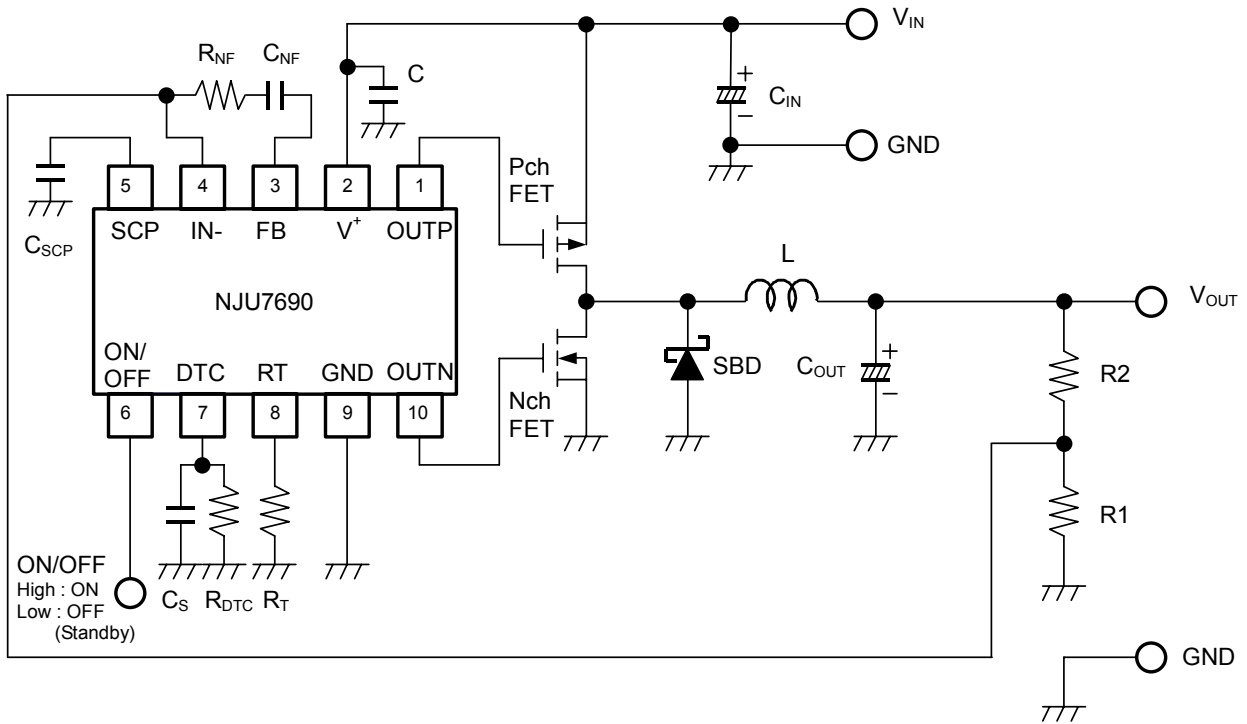

■ TYPICAL CHARACTERISTICS

Oscillation Frequency vs. Timing Resistance
($V^+ = 3.3V$, $T_a = 25^\circ C$)

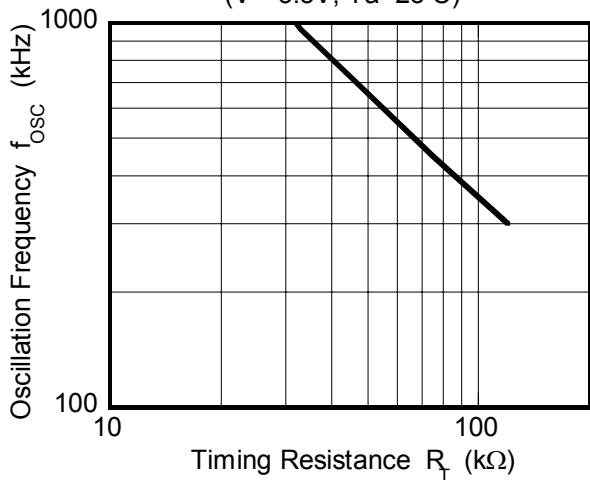

Oscillation Frequency vs. Operating Voltage
($R_T = 47k\Omega$, $T_a = 25^\circ C$)

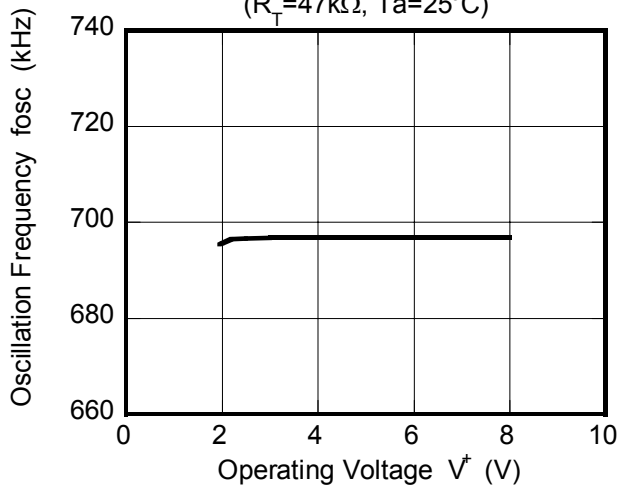

Duty Cycle vs. R_{DTC}

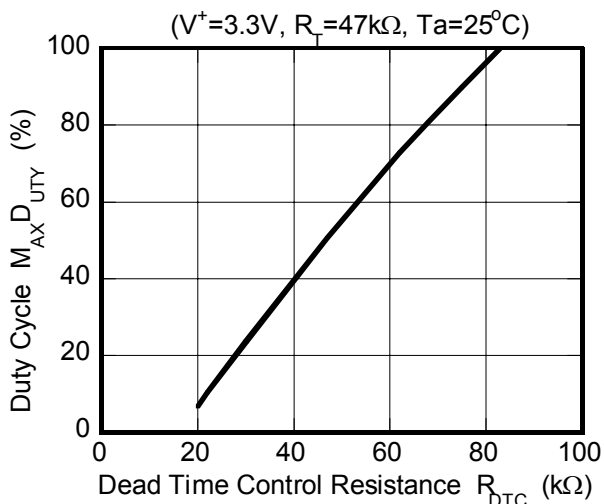

Reference Voltage vs. Operating Voltage
($T_a = 25^\circ C$)

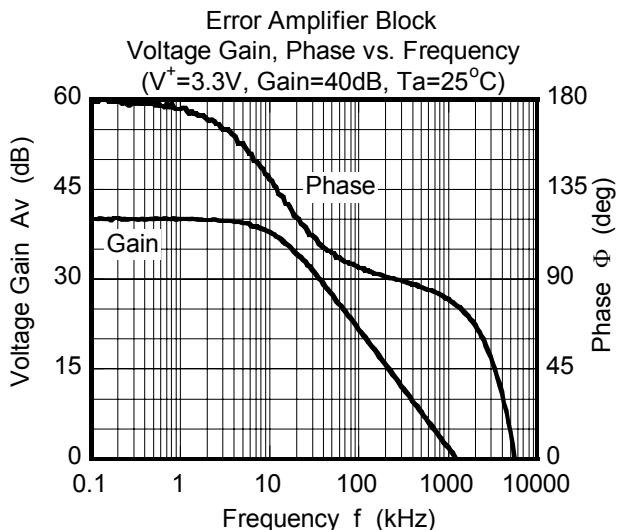
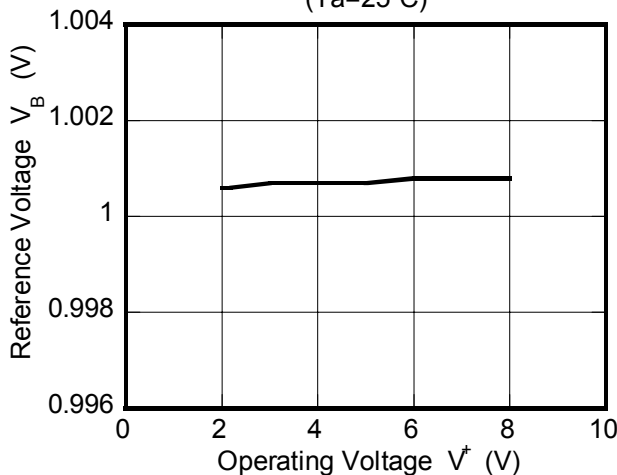

■ TYPICAL CHARACTERISTICS

Quiescent Current vs. Operating Voltage

($R_T=47k\Omega$, R_L = Non Load, $T_a=25^\circ\text{C}$)

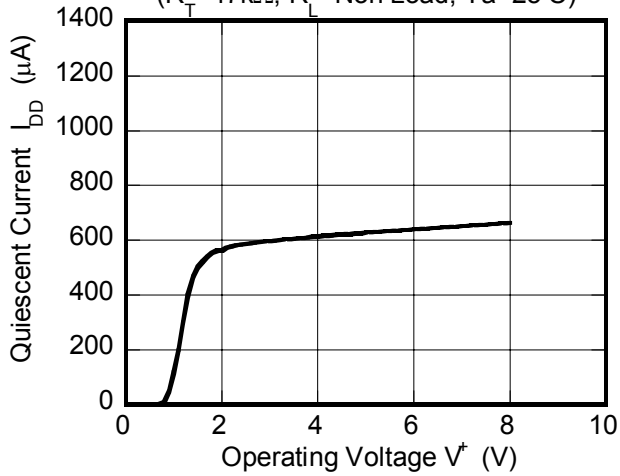

Standby Current vs. Operating Voltage

($R_T=47k\Omega$, $V_{ON/OFF}=0V$, $T_a=25^\circ\text{C}$)

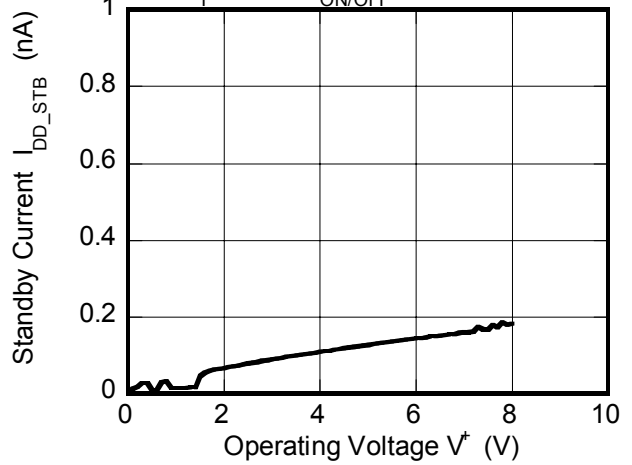

Output Block (P&N)
Output High Level ON Resistance vs. Temperature ($I_o=-20\text{mA}$)

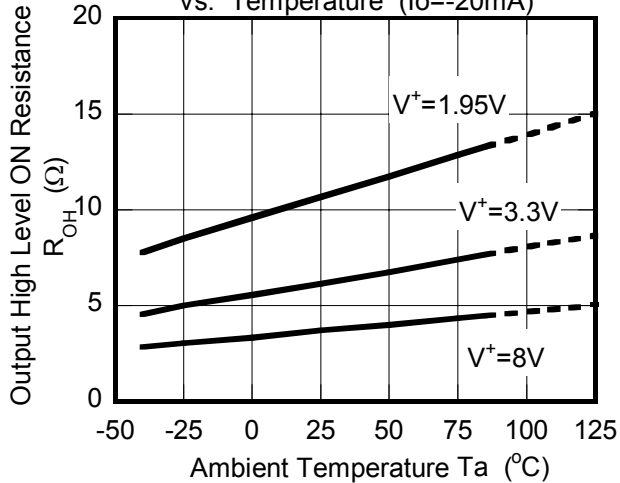

Output Block (P&N)
Output Low Level ON Resistance vs. Temperature ($I_o=+20\text{mA}$)

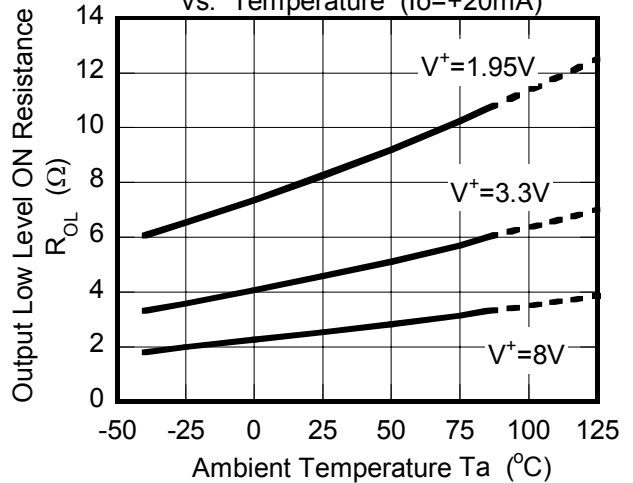

Error Amplifier Block
Output Source Current vs. Temperature ($V_{FB}=1V$, $V_{IN-}=0.9V$)

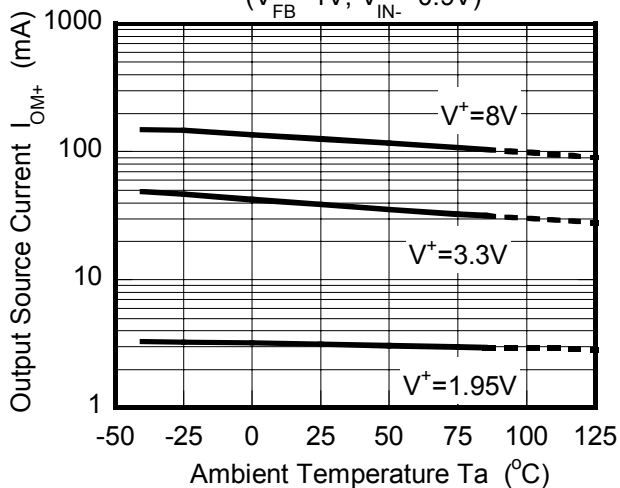

Error Amplifier Block
Output Sink Current vs. Temperature ($V_{FB}=1V$, $V_{IN-}=1.1V$)

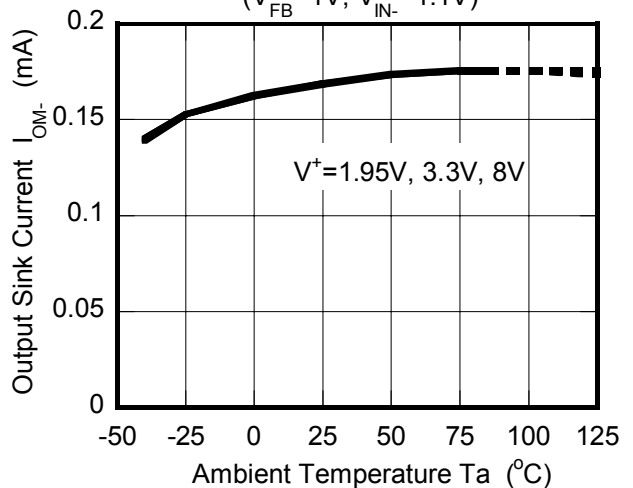

■ TYPICAL CHARACTERISTICS

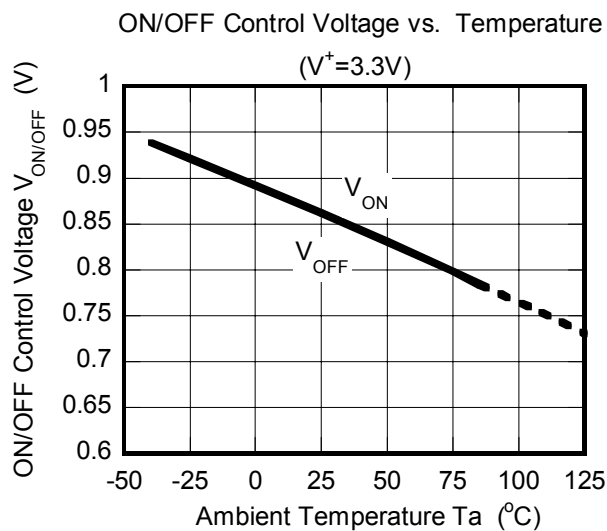
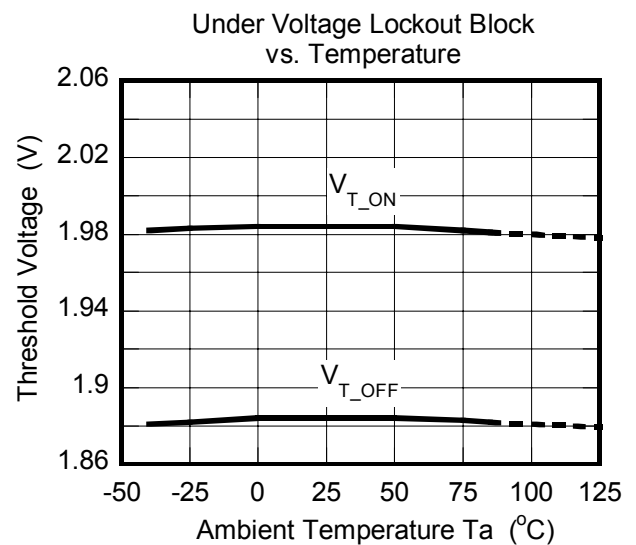
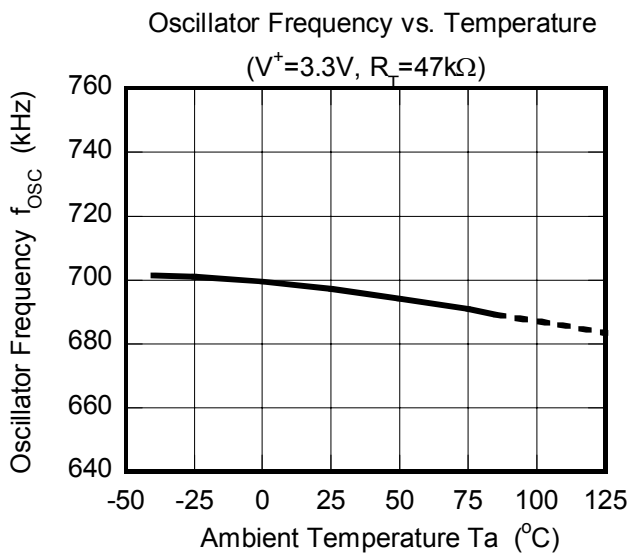
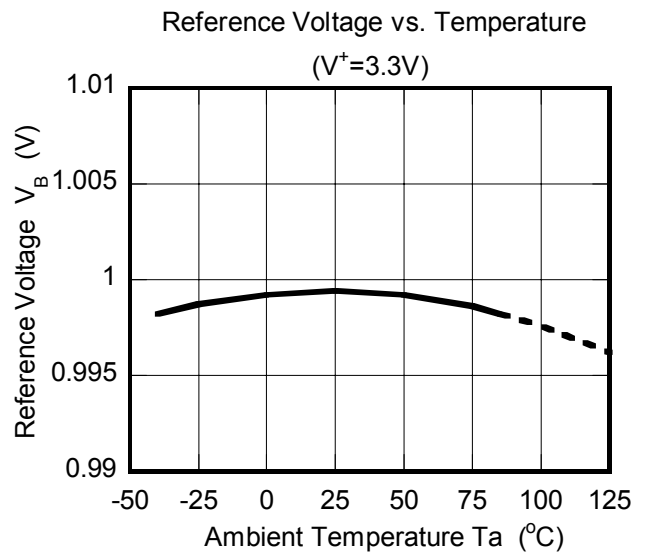
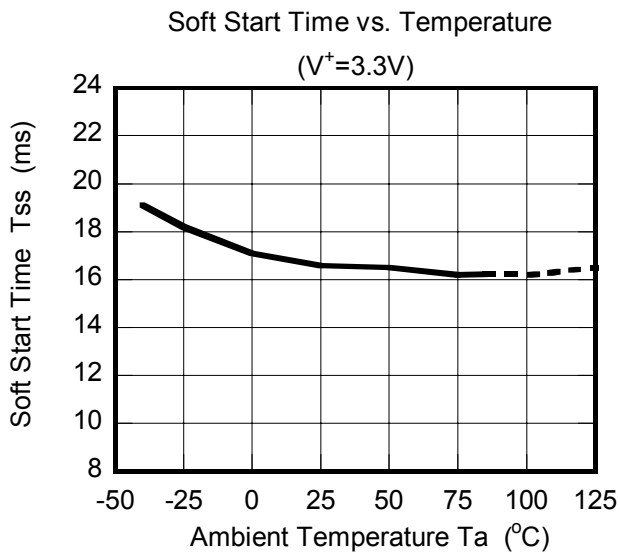

■ TYPICAL CHARACTERISTICS

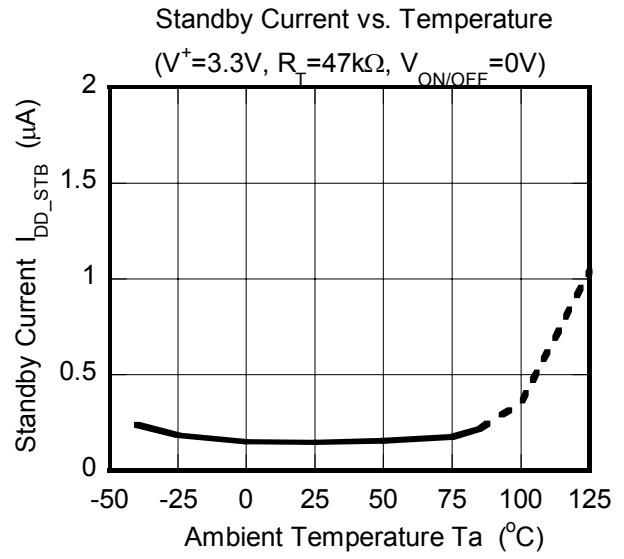
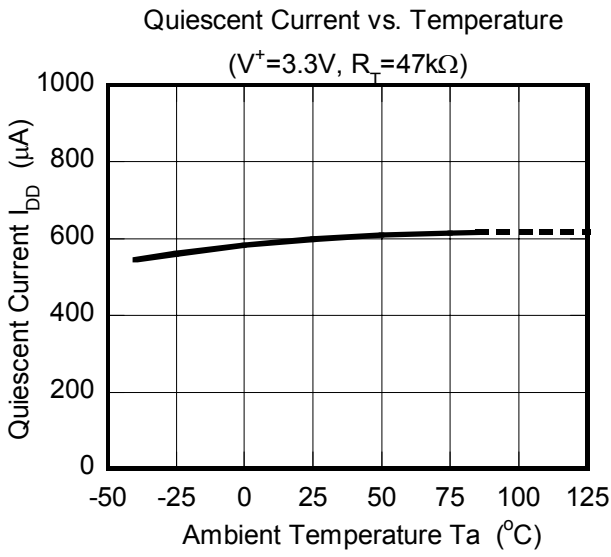

[CAUTION]

The specifications on this databook are only given for information, without any guarantee as regards either mistakes or omissions. The application circuits in this databook are described only to show representative usages of the product and not intended for the guarantee or permission of any right including the industrial rights.