

Single-phase DC Brushless Motor Driver IC

■ GENERAL DESCRIPTION

The NJU7364 is a single phase motor driver IC. It features a MOS FET motor driver, hall bias output, FG output and thermal shutdown circuit.

The driver is capable of 600mA maximum output current and continuous current of 250mA.

■ PACKAGE OUTLINE

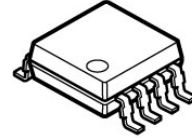

NJU7364RB1

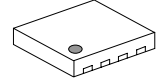

NJU7364KU1

■ FEATURES

- Supply Voltage $V_{DD}=2.0$ to $5.5V$
- Low Quiescent Current $I_{DD}=1mA$ typ.
- Output Voltage $V_{OM}=\pm 0.30V$ typ. @ $I_o=\pm 250mA$
- Hall Bias Terminal
- FG Output
- Thermal Shutdown Circuit
- CMOS Technology
- Package Outline TVSP8 / ESON8-U1

■ BLOCK DIAGRAM

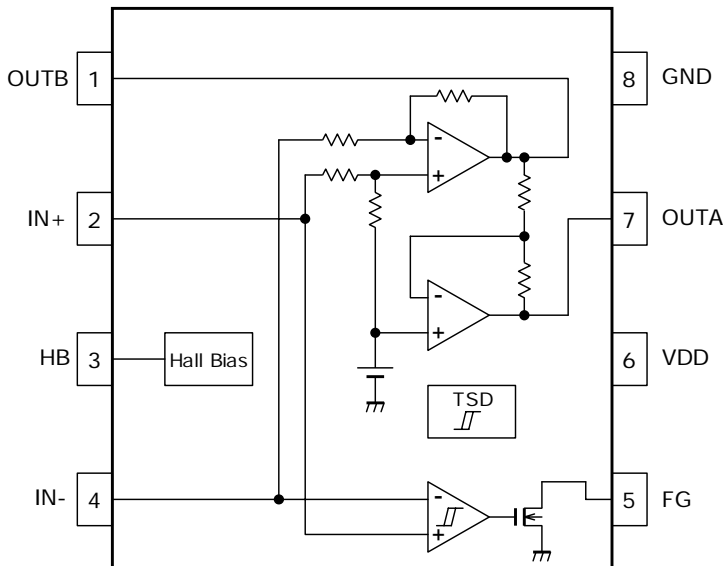

NJU7364

■ ABSOLUTE MAXIMUM RATINGS

(Ta=25°C)

PARAMETER	SYMBOL	RATINGS		UNIT
Supply Voltage	V _{DD}	+7		V
Input Voltage	V _{ID}	-0.3 to V _{DD}		V
Output Current (Peak)	I _{OPEAK}	600		mA
FG Output Current	I _{FG}	10		mA
FG Output Voltage	V _{FG}	+7		V
Power Dissipation (TVSP8)	P _D	Device itself	400	mW
Power Dissipation (ESON8-U1)	P _D	(*1) Mounted on 2Layer Board	450	mW
		(*2) Mounted on 4Layer Board	1,200	
Operating Temperature	Topr	-40 to +85		°C
Junction Temperature	Tjmax	150		°C
Storage Temperature	Tstg	-50 to +150		°C

(*1): Mounted on glass epoxy board based on EIA/JEDEC. (101.5 × 114.5 × 1.6mm: 2-Layers FR-4)

(*2): Mounted on glass epoxy board based on EIA/JEDEC.

(101.5 × 114.5 × 1.6mm: 4-Layers FR-4 Internal foil area: 99.5 × 99.5mm)

■ RECOMMENDED OPERATING CONDITIONS

(Ta=25°C)

PARAMETER	SYMBOL	TEST CONDITION	MIN.	TYP.	MAX.	UNIT
Supply Voltage	V _{DD}	-	2.0	5	5.5	V
Input Common mode Voltage Range	V _{ICM}	-	0.4	-	4.0	V

■ ELECTRICAL CHARACTERISTICS

(V_{DD}=5V, Ta=25°C)

PARAMETER	SYMBOL	TEST CONDITION	MIN.	TYP.	MAX.	UNIT
■ GENERAL						
Quiescent Current	I _{DD}	IN+=4V, IN-=0.4V	-	1.0	2.0	mA
Thermal Shutdown Operating Temperature	T _{TSD}	No-load	-	180	-	°C
Thermal Shutdown Hysteresis	T _{HYS}	No-load	-	50	-	°C
■ HALL AMP BLOCK						
Input Offset Voltage	V _{IO}	No-load	-10	-	10	mV
Close-loop Gain	A _V	No-load	-	44	-	dB
■ OUTPUT BLOCK						
Output Voltage	V _{OH}	I _O = -250mA	4.55	4.7	-	V
	V _{OL}	I _O =250mA	-	0.3	0.45	V
FGL Output Voltage	V _{FG}	I _{FG} =3mA	-	-	0.3	V
FGH Leak Current	I _{FG-LEAK}	V _{FG} =5V	-	-	5.0	uA
■ HALL BIAS BLOCK						
Hall Bias Voltage	V _{HB}	I _{HB} = -5mA	1.1	1.3	1.5	V

■ TRUTH TABLE

IN+	IN-	OUTA	OUTB	FG
H	L	H	L	L (FET Output: ON)
L	H	L	H	Z (FET Output: OFF)

※ Z : High-impedance

■ PIN FUNCTION

• VSP8/TVSP8

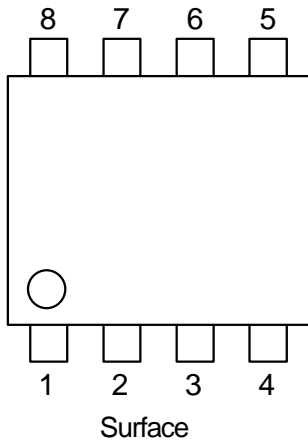

- 1: OUTB
- 2: IN+
- 3: HB
- 4: IN-
- 5: FG
- 6: VDD
- 7: OUTA
- 8: GND

• ESON8-U1

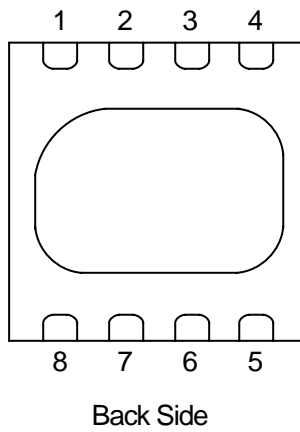
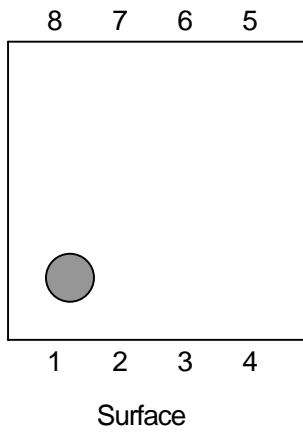

- 1: OUTB
- 2: IN+
- 3: HB
- 4: IN-
- 5: FG
- 6: VDD
- 7: OUTA
- 8: GND

(*3):The PAD in the center part on the back is connected with the internal V_{DD} , therefore it is open or connects to V_{DD} .

NJU7364

■ TYPICAL APPLICATION CIRCUIT

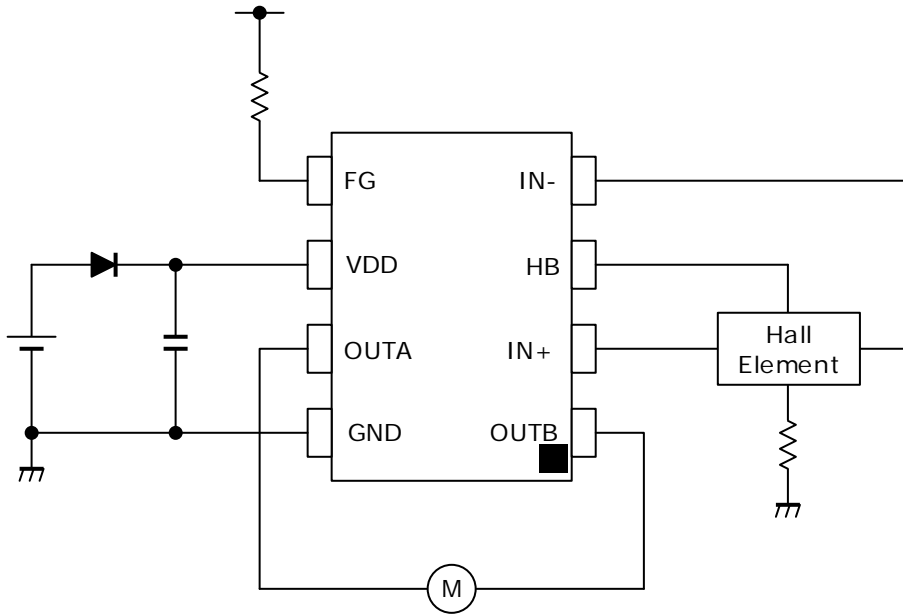

■ POWER DISSIPATION vs. AMBIENT TEMPERATURE

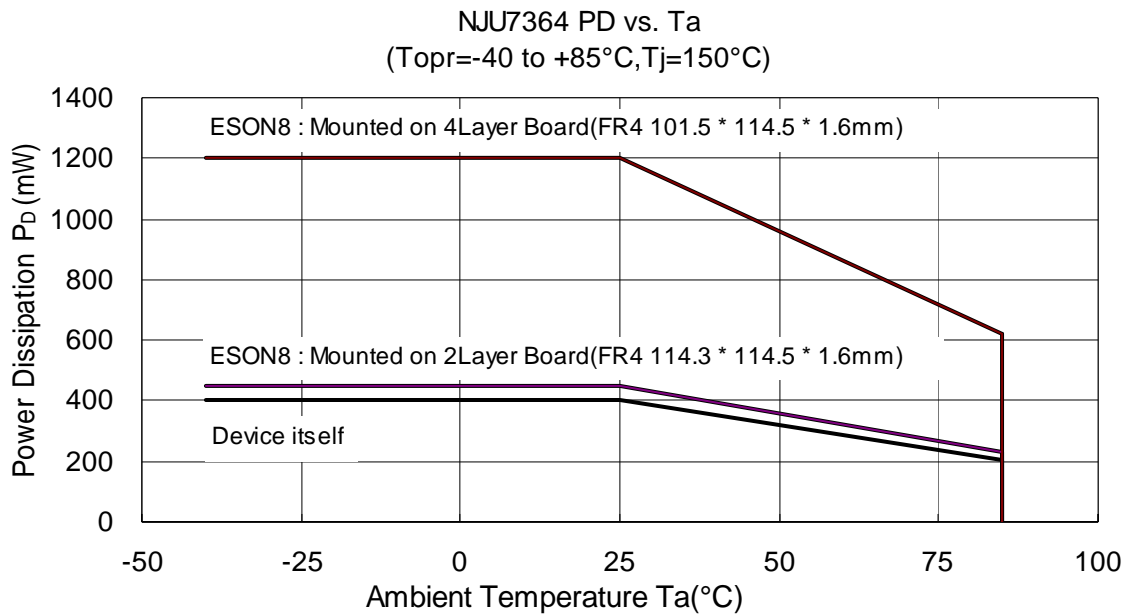

TYPICAL CHARACTERISTICS

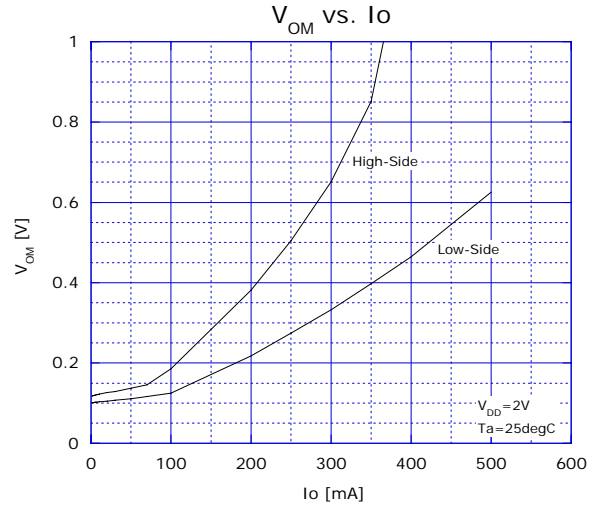
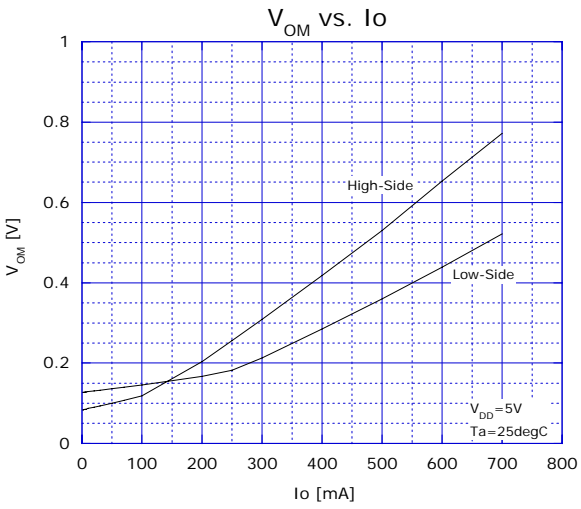
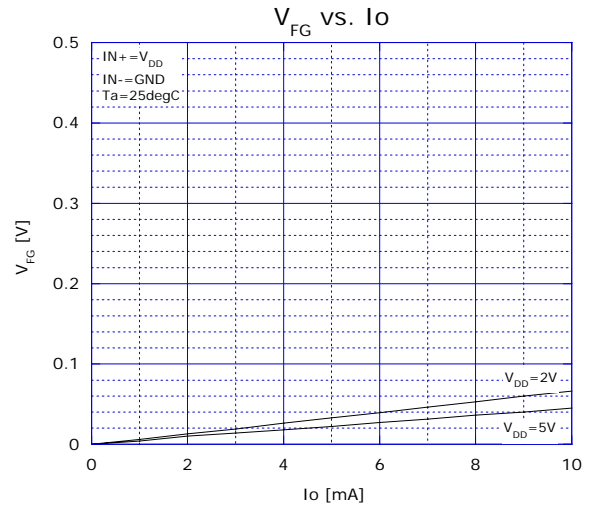
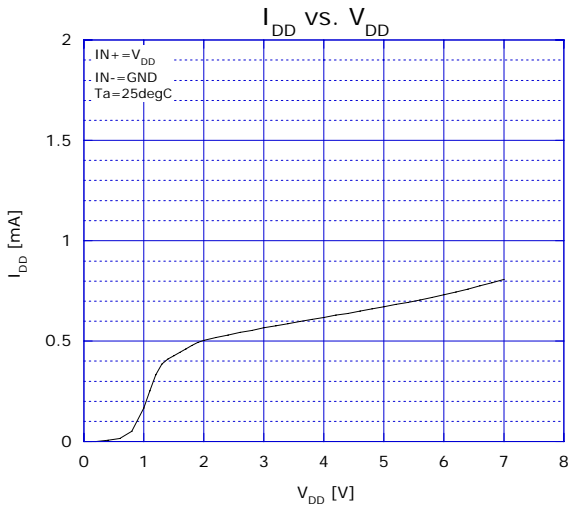

TYPICAL CHARACTERISTICS

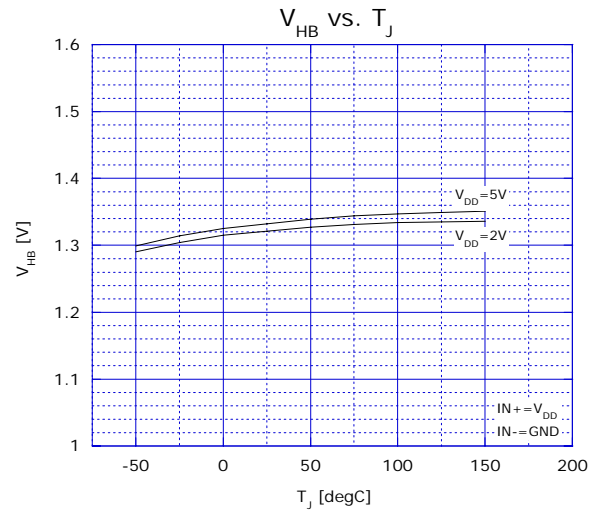
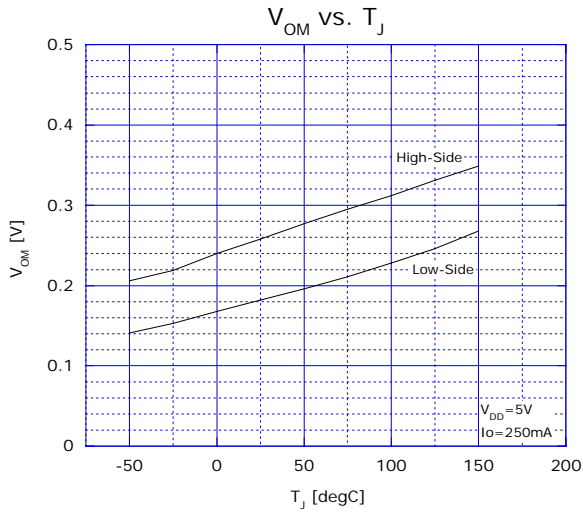
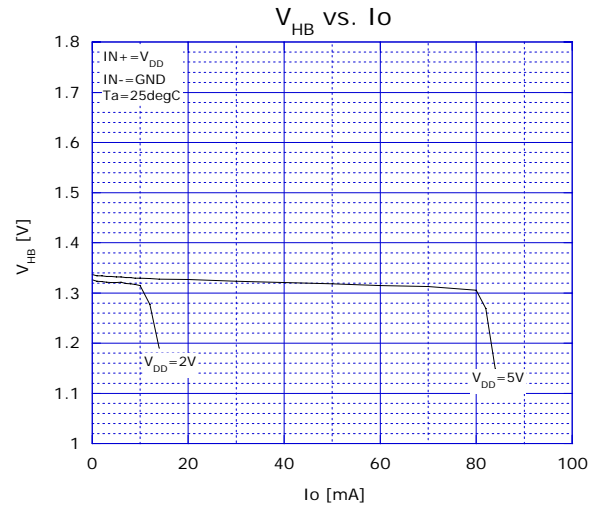
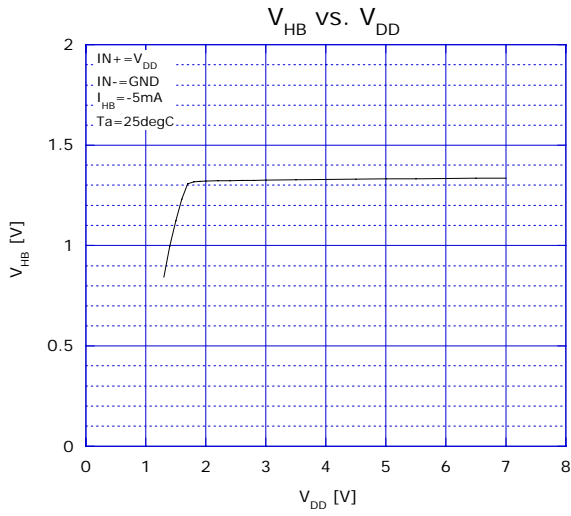

[CAUTION]
 The specifications on this databook are only given for information, without any guarantee as regards either mistakes or omissions. The application circuits in this databook are described only to show representative usages of the product and not intended for the guarantee or permission of any right including the industrial rights.