

SYSTEM RESET IC WITH DELAY CIRCUIT

■ GENERAL DESCRIPTION

The NJU7295 is a system reset IC with built-in delay circuit that monitors the status of a power line, and outputs a reset signal to the microcomputer.

The NJU7295 outputs a reset signal when exceeds the detection voltage. Therefore it is possible to control the microcomputer by detecting a rising edge of a power line.

Delay times are fixed internally and those are set in each of rising and falling.

It is possible to monitor multiplex power line by combination of NJU7295 because output voltage V_{OUT} is kept High level when EXT Pin is Low level by connecting with other NJU7295.

Detection voltage's default value is 1.0V. It can be adjusted to desired voltage by the resistor divider.

In addition, a hysteresis voltage can be set arbitrarily by inserting a resistor between the V_{IN} pin and the HYS pin.

■ PACKAGE OUTLINE

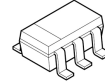

NJU7295F1

■ FEATURES

- High Precision Detection Voltage $\pm 1.0\%$ ($T_a=25^\circ\text{C}$)
- Detection Voltage 1.0V (default) and adjustable with external resistor
- Reset Output Logic Reset Low output when V_{IN} pin is detection voltage or more
*If required reset low output when V_{IN} pin is detection voltage or below, see the NJU7296.
- Delay Circuit (Internal Fixed type) Rising / Falling independent setting
- Ultra Low Quiescent Current 1.7 μA typ.
- Supply Voltage Range 1.5 to 5.5V
- External Input Pin While inputting low signal, keep output High level
- Adjustable Hysteresis Voltage
- Output Type CMOS output
- Package SOT-23-6-1

■ PIN CONFIGURATION

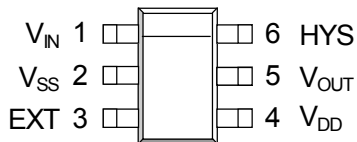

Pin Function

1. V_{IN} : Input Voltage Pin
2. V_{SS} : Ground Pin
3. EXT : External Input Pin
4. V_{DD} : Supply Voltage Pin
5. V_{OUT} : Output Pin
6. HYS : External Resistor Pin for setting Hysteresis Voltage

NJU7295

■ BLOCK DIAGRAM

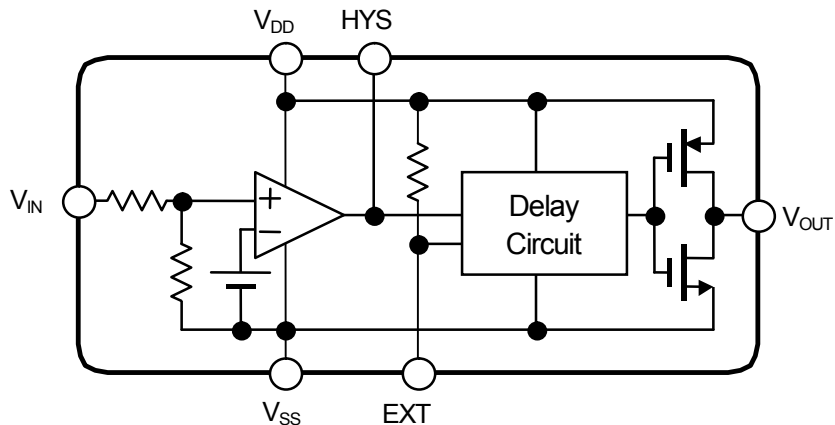

■ PRODUCT CLASSIFICATION

Device Name	Version	Delay Time1(Typ.)	Delay Time2(Typ.)	Spec Guarantee	
NJU7295F1-A	A	10ms	1.25ms	25°C	(General Spec.)
NJU7295F1-A-T				-40°C to +105°C	(T Spec.)
NJU7295F1-B	B	20ms	10ms	25°C	(General Spec.)
NJU7295F1-B-T				-40°C to +105°C	(T Spec.)
NJU7295F1-C	C	10ms	10ms	25°C	(General Spec.)
NJU7295F1-C-T				-40°C to +105°C	(T Spec.)
NJU7295F1-D	D	10ms	30μs	25°C	(General Spec.)
NJU7295F1-D-T				-40°C to +105°C	(T Spec.)

■ ABSOLUTE MAXIMUM RATINGS

(Ta=25°C)

PARAMETER	SYMBOL	RATINGS	UNIT	
Supply Voltage	V _{DD}	+7	V	
Input Voltage	V _{IN}	V _{SS} -0.3 to +7	V	
Output Voltage	V _{OUT}	V _{SS} -0.3 to V _{DD} +0.3	V	
HYS Pin Voltage	V _{HYS}	V _{SS} -0.3 to V _{DD} +0.3	V	
EXT Pin Input Voltage	V _{EXT}	V _{SS} -0.3 to V _{DD} +0.3	V	
Output Current	I _{OUT}	50	mA	
HYS Pin Current	I _{HYS}	10	mA	
Power Dissipation	P _D	SOT-23-6-1	410(*1)	mW
			580(*2)	
Surge Current	I _{IN_SRG}	±2.5(*3)	mA	
Operating Temperature	T _{opr}	-40 to +105	°C	
Storage Temperature	T _{stg}	-40 to +125	°C	

(*1): Mounted on glass epoxy board. (76.2×114.3×1.6mm: based on EIA/JDEC standard, 2Layers)

(*2): Mounted on glass epoxy board. (76.2×114.3×1.6mm: based on EIA/JDEC standard, 4Layers), internal Cu area: 74.2×74.2mm

(*3): Permissible current range there is no logical error in V_{OUT} and no destruction

■ ELECTRICAL CHARACTERISTICS

Unless otherwise noted, $V_{DD}=3.3V$, $T_a=25^{\circ}C$

PARAMETER	SYMBOL	TEST CONDITION	MIN.	TYP.	MAX.	UNIT
Detection Voltage	V_{DET}		-1.0%	1.0	+1.0%	V
		$T_a=-40^{\circ}C$ to $105^{\circ}C$	-2.5%	-	+2.5%	
Quiescent Current	I_{SS}	No Signal	-	1.7	3.0	μA
		No Signal, $T_a=-40^{\circ}C$ to $105^{\circ}C$	-	-	3.5	
Output Current	I_{OUT}	Nch, $V_{DS}=0.5V$	12	15	-	mA
		Nch, $V_{DS}=0.5V$, $T_a=-40^{\circ}C$ to $105^{\circ}C$	10	-	-	
		Pch, $V_{DS}=0.5V$	7.5	11	-	
		Pch, $V_{DS}=0.5V$, $T_a=-40^{\circ}C$ to $105^{\circ}C$	6.0	-	-	
HYS Pin Current	I_{HYS}	Nch, $V_{DS}=0.5V$	7.5	12	-	mA
		Nch, $V_{DS}=0.5V$, $T_a=-40^{\circ}C$ to $105^{\circ}C$	6.0	-	-	
		Pch, $V_{DS}=0.5V$	5.0	9.0	-	
		Pch, $V_{DS}=0.5V$, $T_a=-40^{\circ}C$ to $105^{\circ}C$	4.0	-	-	
Average Temperature Coefficient of Detection Voltage	$\Delta V_{DET}/\Delta T_a$	$T_a=0^{\circ}C$ to $+85^{\circ}C$	-	± 100	-	ppm/ $^{\circ}C$
EXT Pin High Level Voltage	V_{EXT_H}		$0.67 \times V_{DD}$	-	V_{DD}	V
		$T_a=-40^{\circ}C$ to $105^{\circ}C$	$0.7 \times V_{DD}$	-	V_{DD}	
EXT Pin Low Level Voltage	V_{EXT_L}		-	-	$0.33 \times V_{DD}$	V
		$T_a=-40^{\circ}C$ to $105^{\circ}C$	-	-	$0.3 \times V_{DD}$	
V_{IN} Pin Resistance	R_{IN}		10	20	-	$M\Omega$
		$T_a=-40^{\circ}C$ to $105^{\circ}C$	8	-	-	
EXT Pin Resistance	R_{EXT}		0.5	1.0	-	$M\Omega$
		$T_a=-40^{\circ}C$ to $105^{\circ}C$	0.4	-	-	
Operating Voltage	V_{OPL}		1.5	-	5.5	V
		$T_a=-40^{\circ}C$ to $105^{\circ}C$	1.5	-	5.5	

■ ELECTRICAL CHARACTERISTICS (Defined by each versions)

Unless otherwise noted, $V_{DD}=3.3V$, $T_a=25^{\circ}C$

PARAMETER	SYMBOL	TEST CONDITION	MIN.	TYP.	MAX.	UNIT	
Delay Time 1	t_{d1}	$V_{IN}=L \rightarrow H$	NJU7295F1-A	7	10	14	ms
			NJU7295F1-A-T, $T_a=-40^{\circ}C$ to $105^{\circ}C$	6	-	14	
			NJU7295F1-B	16	20	24	ms
			NJU7295F1-B-T, $T_a=-40^{\circ}C$ to $105^{\circ}C$	15	-	25	
			NJU7295F1-C	7	10	14	ms
			NJU7295F1-C-T, $T_a=-40^{\circ}C$ to $105^{\circ}C$	6	-	14	
			NJU7295F1-D	7	10	14	ms
			NJU7295F1-D-T, $T_a=-40^{\circ}C$ to $105^{\circ}C$	6	-	14	
Delay Time 2	t_{d2}	$V_{IN}=H \rightarrow L$	NJU7295F1-A	1.05	1.25	1.43	ms
			NJU7295F1-A-T, $T_a=-40^{\circ}C$ to $105^{\circ}C$	1.0	-	1.5	
			NJU7295F1-B	7	10	14	ms
			NJU7295F1-B-T, $T_a=-40^{\circ}C$ to $105^{\circ}C$	6	-	14	
			NJU7295F1-C	7	10	14	ms
			NJU7295F1-C-T, $T_a=-40^{\circ}C$ to $105^{\circ}C$	6	-	14	
			NJU7295F1-D	-	30	100	μs
			NJU7295F1-D-T, $T_a=-40^{\circ}C$ to $105^{\circ}C$	-	-	120	

NJU7295

■ TEST CIRCUIT

- Quiescent Current

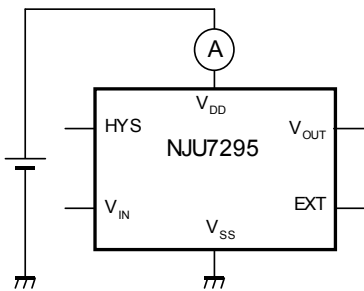

- Detection Voltage

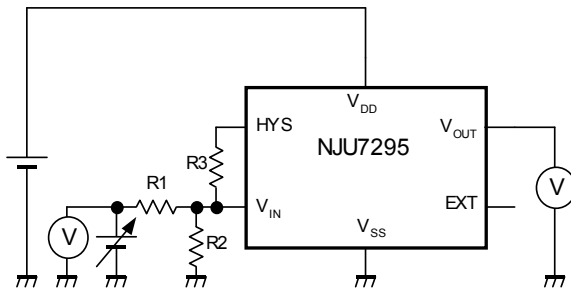

- Output Current

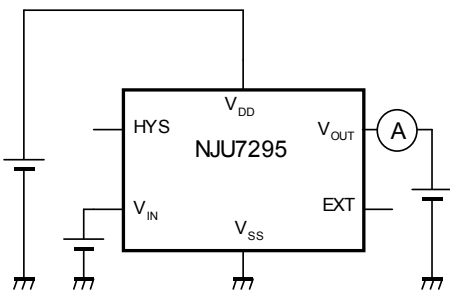

- HYS Pin Current

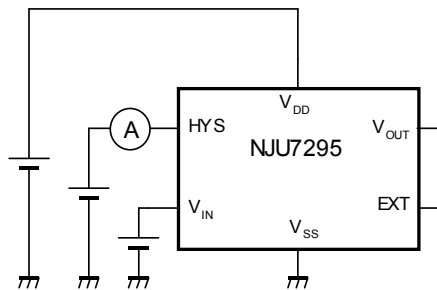

- EXT Pin Input Voltage

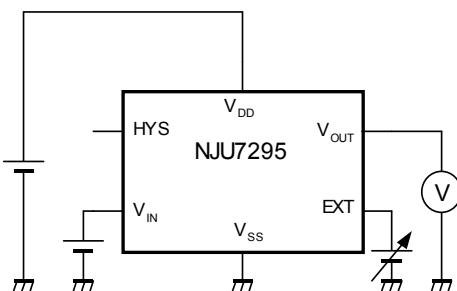

- Delay Time

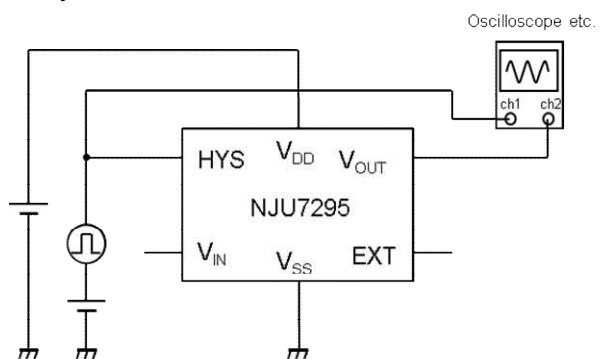

- Minimum Operating Voltage

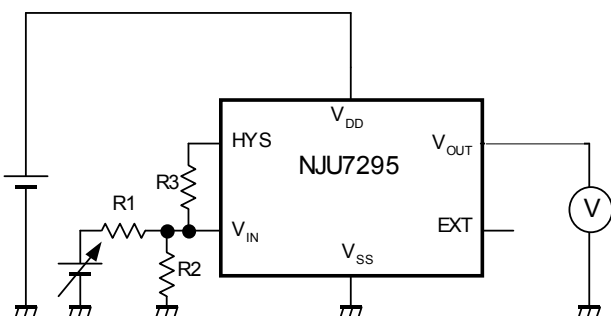

■ FUNCTION DESCRIPTION

(1) Basic Operation

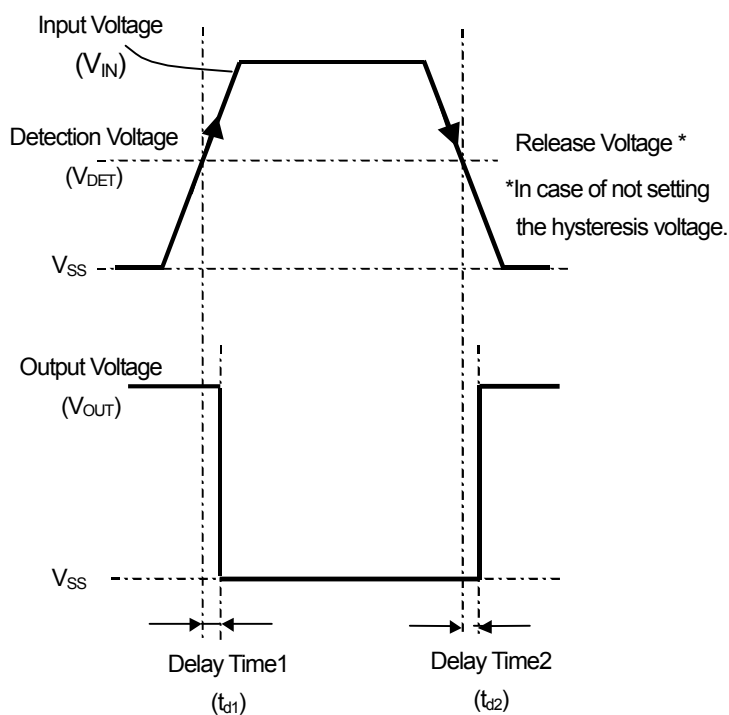

- (1) When input voltage V_{IN} is increased and exceed the detection voltage V_{DET} , after the delay time which is fixed for each version, the output voltage V_{OUT} is switched from High level to Low level.
- (2) In the state of V_{IN} is above the release voltage V_{DET} , the reset state is maintained. The default release voltage V_{DET} is same as detection voltage V_{DET} , although can be set the hysteresis by inserting a resistor between the V_{IN} pin and the HYS pin.
- (3) When V_{IN} falls and it reaches release voltage V_{DET} , after the delay time which is fixed for each version, V_{OUT} is switched from Low level to High level.

■ TYPICAL APPLICATION

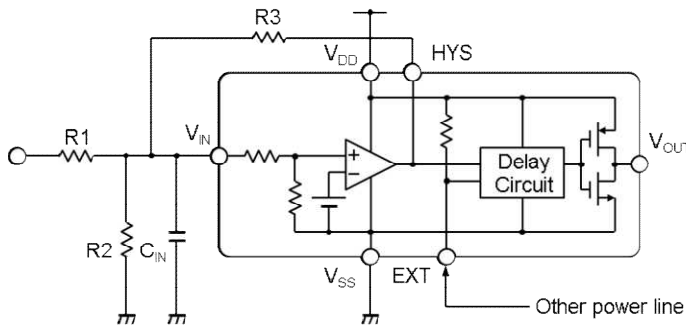

R1, R2: Adjust the detection voltage by resistor divider

R3: Setting the hysteresis voltage

C_{IN}: To prevent malfunction due to noise (Recommend about 10pF to 1000pF)

EXT: The input logic signals from other power line

● Adjusting of Detection Voltage

The Detection voltage of NJU7295 is fixed as 1.0V (typ.) internally, although it can be adjusted to a desired Detection Voltage by connecting external resistor (R1,R2) to a V_{IN} pin.

When adjusting to a desired Detection Voltage, it's necessary to consider V_{IN} pin resistance R_{IN}. (20 MΩ typ.)

● Setting of Hysteresis Voltage

The NJU7295 doesn't have the Hysteresis Voltage between the Release Voltage and Detecting Voltage in default. It's able to set the Hysteresis Voltage optionally by connecting dividing resistor between the V_{IN}-HYS pin.

$$\text{Detection Voltage} = V_{DET} + \frac{R1(R2 + R_{IN})}{R_{IN} \cdot R2} V_{DET} + \frac{R1}{R3} V_{DET}$$

$$\text{Hysteresis Voltage} = \frac{R1}{R3} V_{DD}$$

$$\text{Release Voltage} = \text{Detection Voltage} - \text{Hysteresis Voltage}$$

● External input Pin

If inputs the logic signal from other power line(e.g. other NJU7295) into the EXT pin, it can be kept the status of the output "High level" and ignoring the status of detection voltage V_{DET}.

When inputs a low level signal into the EXT pin, V_{OUT} is kept high level. It is useful for priority setting of reset signal when monitoring multiplex power supply systems.

If do not use the External input, the EXT pin should be connected to V_{DD} or Open.

■ TYPICAL CHARACTERISTICS

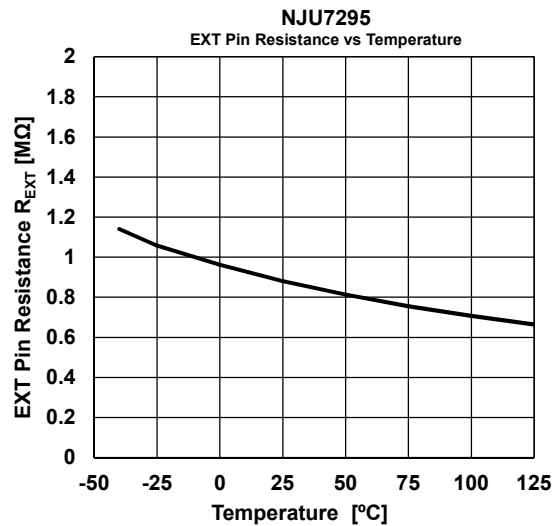
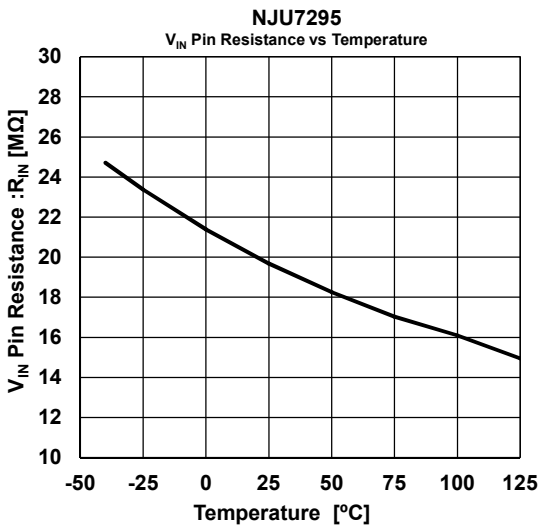
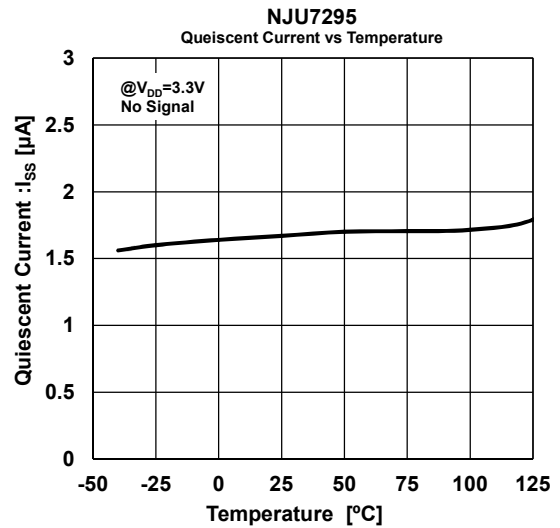
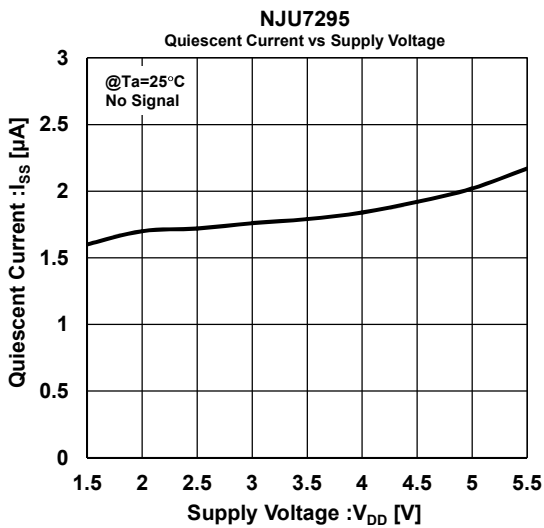
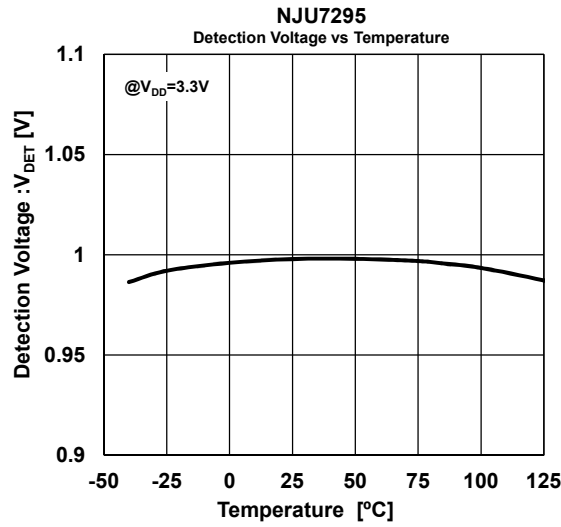

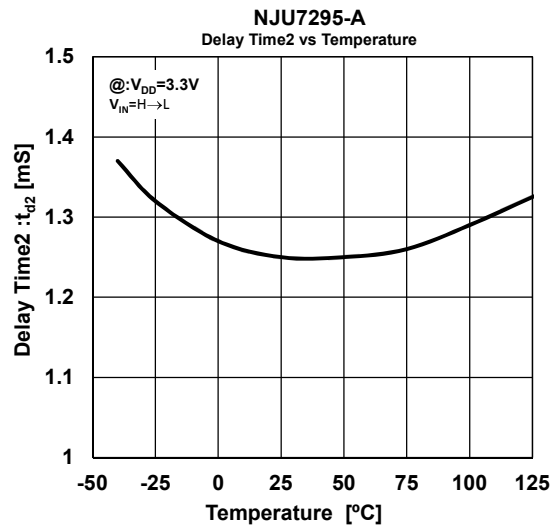
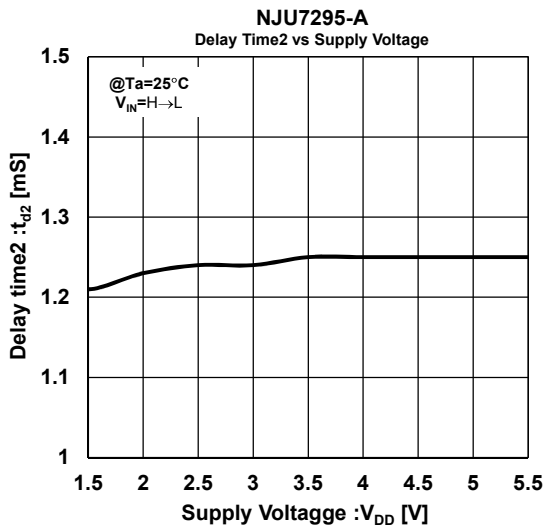
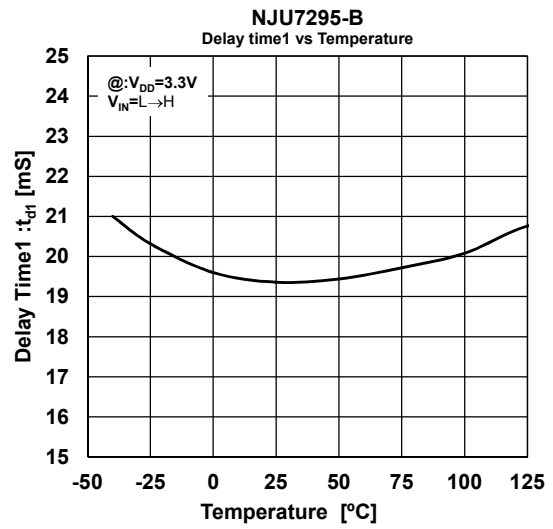
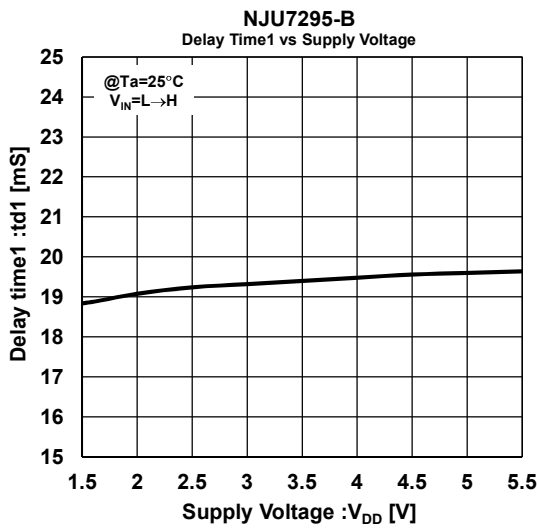
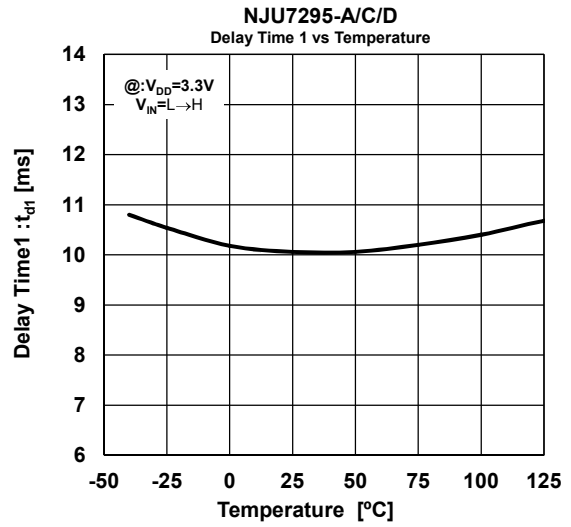
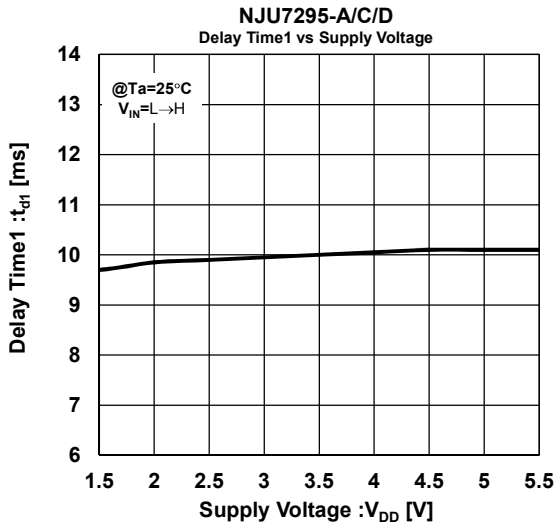

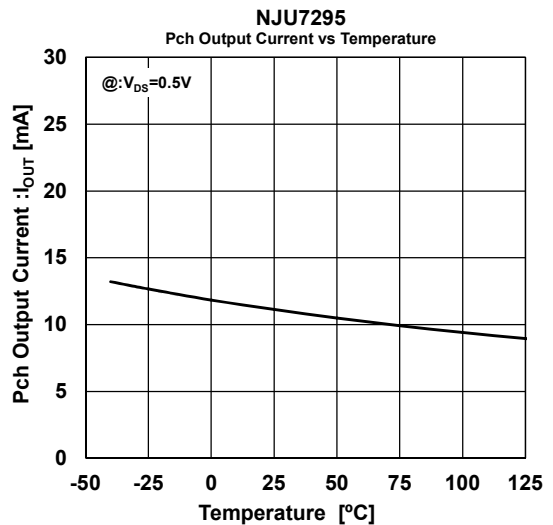
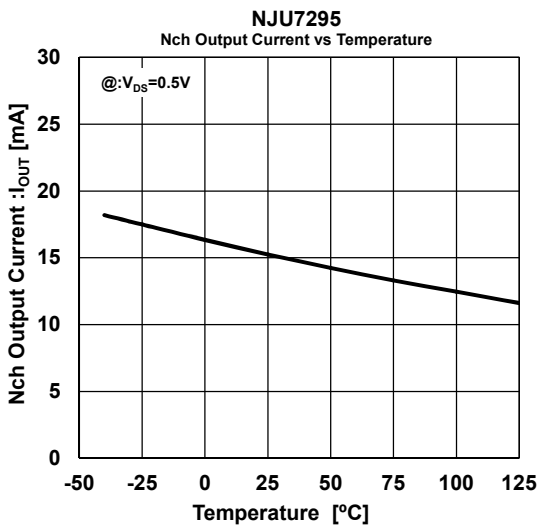
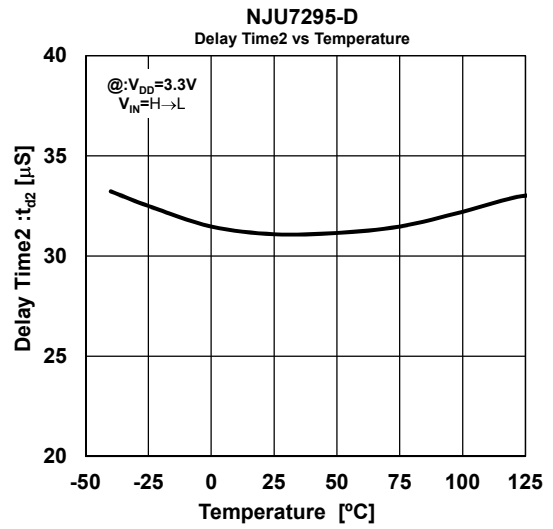
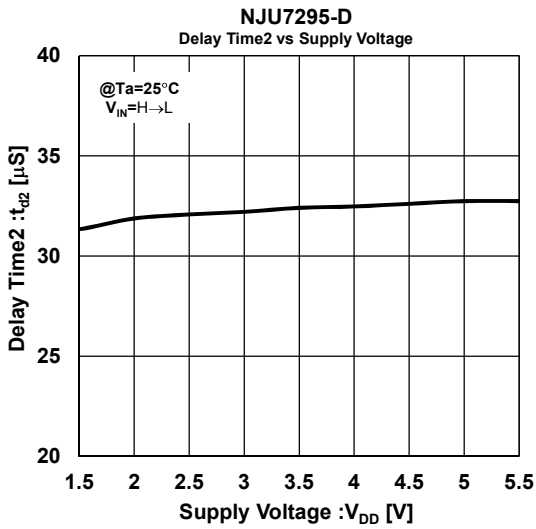
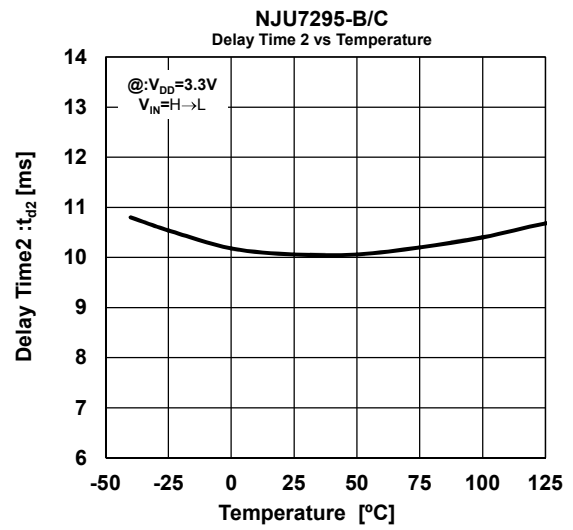
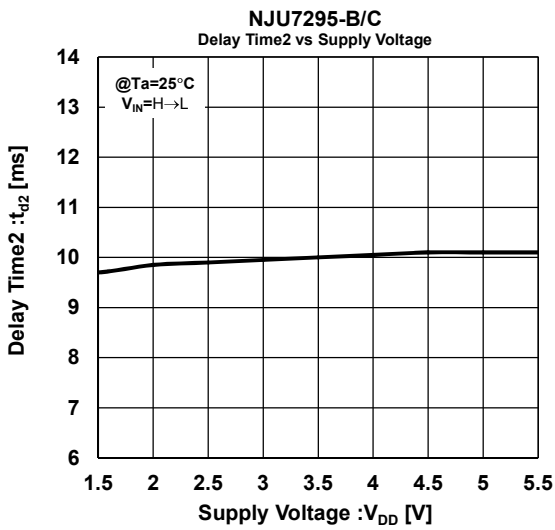

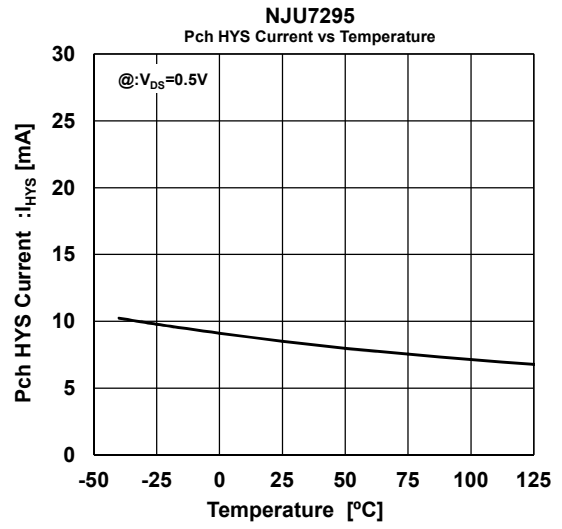
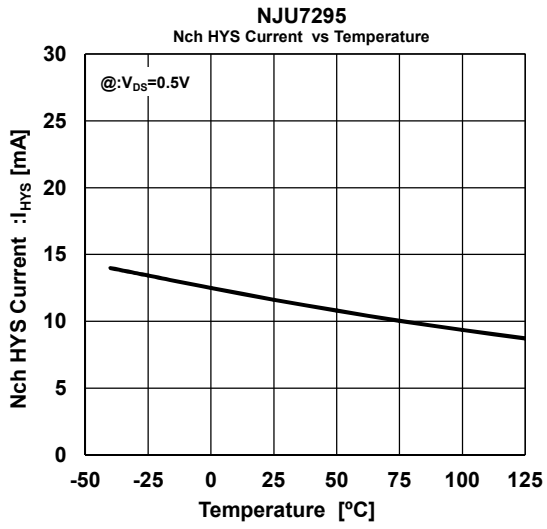

[CAUTION]
The specifications on this databook are only given for information, without any guarantee as regards either mistakes or omissions. The application circuits in this databook are described only to show representative usages of the product and not intended for the guarantee or permission of any right including the industrial rights.