

## 2ch LOW DROPOUT VOLTAGE REGULATOR

### ■ GENERAL DESCRIPTION

The NJU7254 is a 2ch low dropout voltage regulator with ON/OFF control. Advanced C-MOS technology achieves high ripple rejection and low quiescent current.

SOT-23-6 package, 100mA×2ch output current and 1.0μF small capacitor make NJU7254 suitable for space conscious applications.

### ■ PACKAGE OUTLINE



NJU7254F1

### ■ FEATURES

- High Ripple Rejection      65dB typ. (f=1kHz, Vo=3V Version)
- Low Quiescent Current      18μA/ch(typ.), 30μA/total (typ.)
- Output capacitor with 1.0μF ceramic capacitor
- Output Current              Io(max.)=100mA ×2ch
- High Precision Output      Vo±1.0%
- Low Dropout Voltage      0.09V typ. (Io=60mA, Vo=3V Version)
- ON/OFF Control (Each ch.)
- Internal Short Circuit Current Limit
- C-MOS technology
- Package Outline              SOT-23-6

### ■ PIN CONFIGURATION

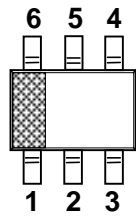

NJU7254F1

#### PIN FUNCTION

1. V<sub>OUT2</sub>
2. GND
3. V<sub>OUT1</sub>
4. CONTROL1
5. V<sub>IN</sub>
6. CONTROL2

### ■ EQUIVALENT CIRCUIT

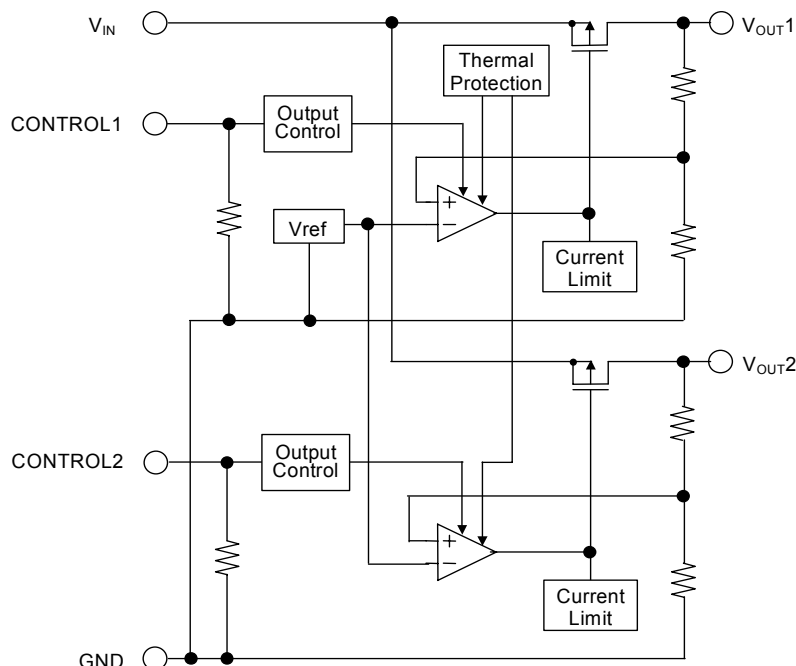

# NJU7254

## ■ OUTPUT VOLTAGE RANK LIST

Device Name	V <sub>OUT</sub>	
	CH1	CH2
NJU7254F1-2121	2.1V	2.1V
NJU7254F1-0303	3.0V	3.0V
NJU7254F1-0521	5.0V	2.1V

## ■ ABSOLUTE MAXIMUM RATINGS (Ta=25°C)

PARAMETER	SYMBOL	RATINGS	UNIT
Input Voltage	V <sub>IN</sub>	+9	V
Control Voltage	V <sub>CONT</sub>	+9(*1)	V
Power Dissipation	P <sub>D</sub>	SOT-23-6 200(*2) 400(*3)	mW
Operating Temperature	Topr	-40~+85	°C
Storage Temperature	Tstg	-40~+125	°C

(\*1): When input voltage is less than +14V, the absolute maximum control voltage is equal to the input voltage.

(\*2): Device itself.

(\*3): Mounted on glass epoxy board based on EIA/JEDEC. (114.3x76.2x1.6mm: 2Layers)

## ■ Operating voltage

V<sub>IN</sub>=+2.3 ~ +8V (In case of Vo<2.1V version)

## ■ ELECTRICAL CHARACTERISTICS (V<sub>IN</sub>=V<sub>O</sub>+1V(\*4), C<sub>IN</sub>=0.1μF, C<sub>O</sub>=1.0μF (Vo≤2.0V : Co=2.2μF), Ta=25°C)

PARAMETER	SYMBOL	TEST CONDITION	MIN.	TYP.	MAX.	UNIT	
Output Voltage	V <sub>O</sub>	I <sub>O</sub> =30mA	-1.0%	—	+1.0%	V	
Input Voltage	V <sub>IN</sub>		—	—	8	V	
Quiescent Current 1	I <sub>Q1</sub>	V <sub>CONT1</sub> =V <sub>IN</sub> , V <sub>CONT2</sub> =0V or V <sub>CONT1</sub> =0V, V <sub>CONT2</sub> =V <sub>IN</sub> , I <sub>O</sub> =0mA, Include I <sub>CONT</sub>	—	18	35	μA	
Quiescent Current 2	I <sub>Q2</sub>	V <sub>CONT1</sub> =V <sub>CONT2</sub> =V <sub>IN</sub> , I <sub>O</sub> =0mA, Include I <sub>CONT</sub>	—	30	60	μA	
Quiescent Current at Control OFF	I <sub>Q(OFF)</sub>	V <sub>CONT1</sub> =V <sub>CONT2</sub> =0V	—	0.1	1	μA	
Output Current	I <sub>O</sub>	V <sub>O</sub> -0.1V (V <sub>O</sub> ≤2.0V Version) V <sub>O</sub> -0.3V (V <sub>O</sub> ≥2.1V Version)	100	—	—	mA	
Short Circuit Limit	I <sub>LIM</sub>	V <sub>O</sub> =0V	—	40	—	mA	
Line Regulation	ΔV <sub>O</sub> /ΔV <sub>IN</sub>	V <sub>IN</sub> =V <sub>O</sub> +1V~V <sub>O</sub> +6V (V <sub>O</sub> <2.0V Version) V <sub>IN</sub> =V <sub>O</sub> +1V~8.0V (V <sub>O</sub> ≥2.0V Version), I <sub>O</sub> =30mA	—	—	0.20	%/V	
Load Regulation	ΔV <sub>O</sub> /ΔI <sub>O</sub>	I <sub>O</sub> =0~100mA	—	—	0.03	%/mA	
Dropout Voltage	ΔV <sub>I-O</sub>	I <sub>O</sub> =60mA	2.1V≤V <sub>O</sub> ≤2.4V	—	0.11	0.16	V
			2.5V≤V <sub>O</sub> ≤2.7V	—	0.10	0.15	V
			2.8V≤V <sub>O</sub> ≤3.3V	—	0.09	0.14	V
			3.4V≤V <sub>O</sub> ≤5.0V	—	0.07	0.12	V
Average Temperature Coefficient of Output Voltage	ΔV <sub>O</sub> /ΔTa	Ta=0~85°C, I <sub>O</sub> =10mA	—	±100	—	ppm/°C	
Output Noise Voltage	V <sub>NO1</sub>	f=10Hz ~ 80kHz, I <sub>O</sub> =0mA, V <sub>O</sub> =3.0V Version	—	75	—	μVrms	
Pull-down Resistance	R <sub>CONT</sub>		2	5	10	MΩ	
Control Voltage for ON-state	V <sub>CONT(ON)</sub>		1.6	—	—	V	
Control Voltage for OFF-state	V <sub>CONT(OFF)</sub>		—	—	0.3	V	

(\*4): V<sub>IN</sub>=V<sub>O</sub>+1V means add 1V to higher output voltage.

(\*5): The output voltage excludes under 2.1V.

The above specification is a common specification for all voltages.

Therefore, it may be different from the individual specification for a specific output Voltage.

## POWER DISSIPATION vs. AMBIENT TEMPERATURE

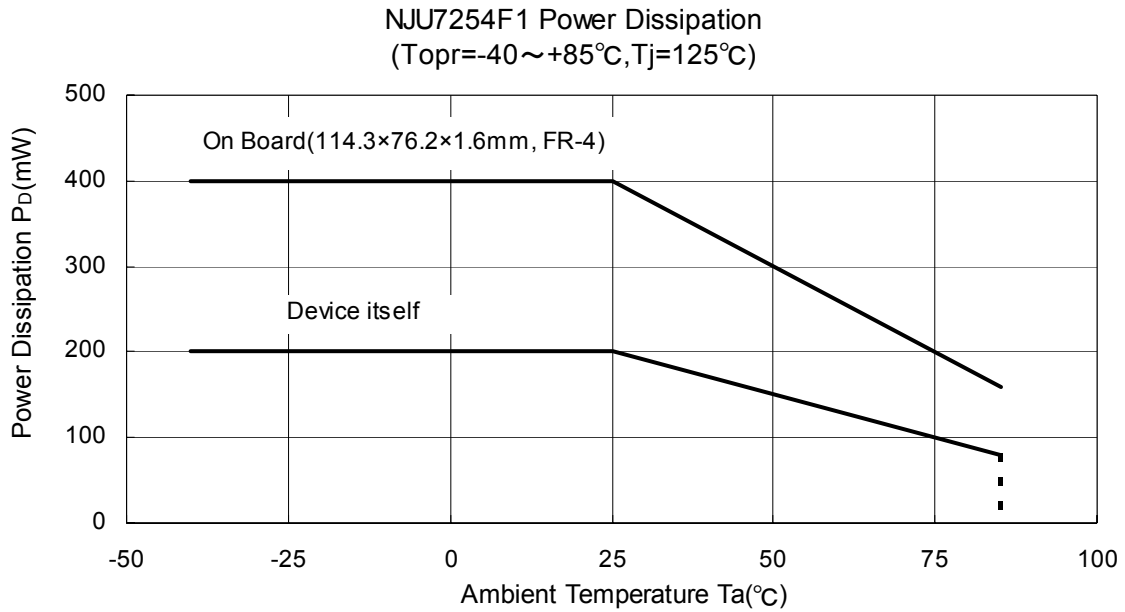

## TEST CIRCUIT

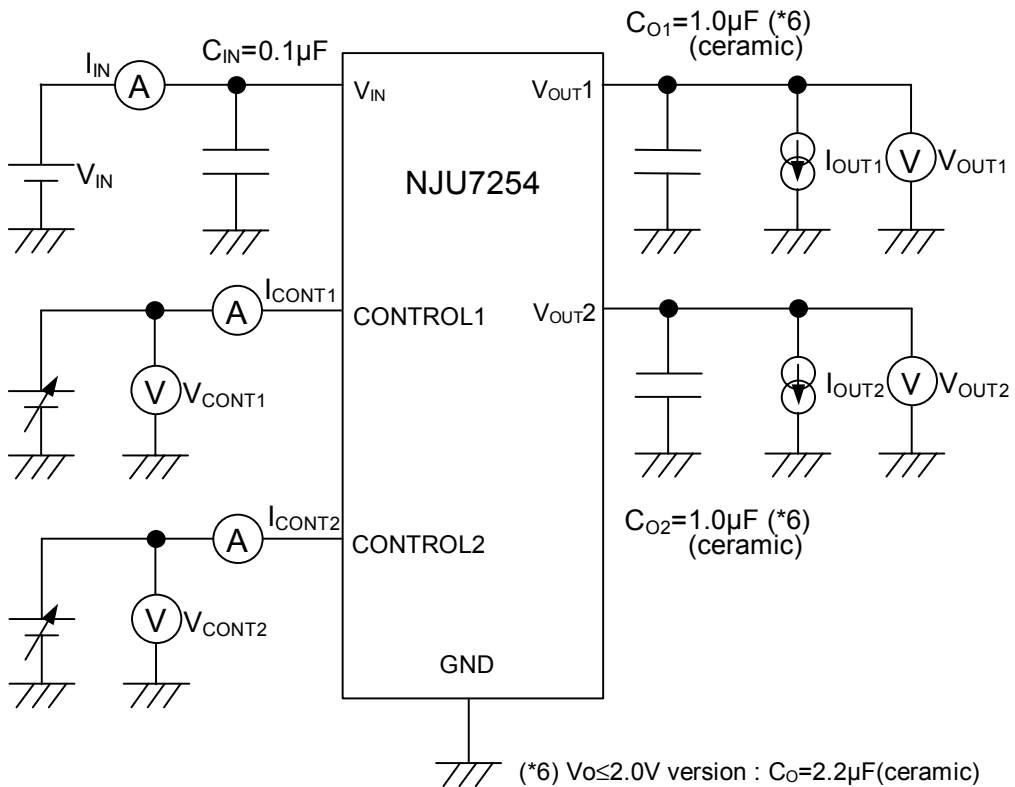

# NJU7254

## ■ TYPICAL APPLICATION

① In case that ON/OFF Control is not required:

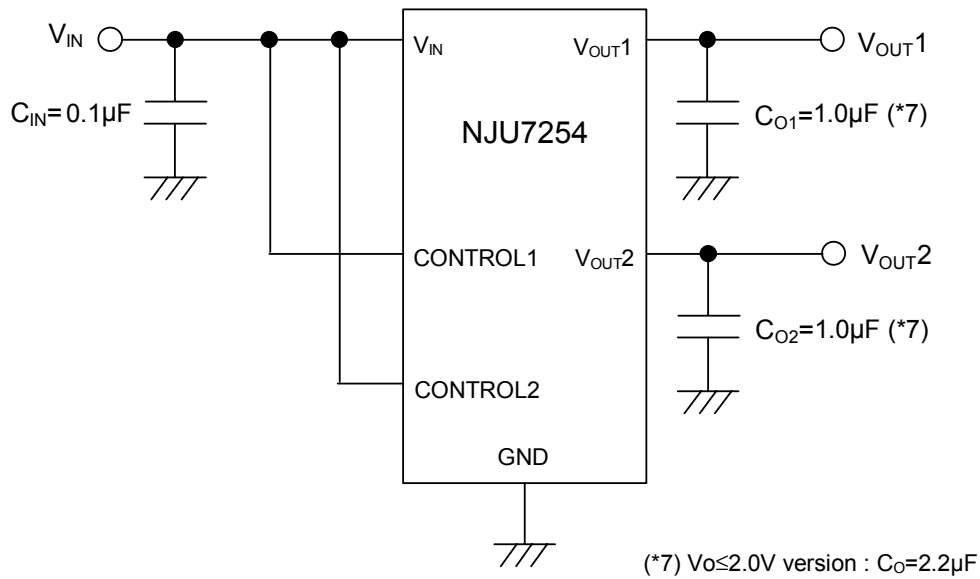

Connect control terminal to V<sub>IN</sub> terminal.

② In use of ON/OFF Control

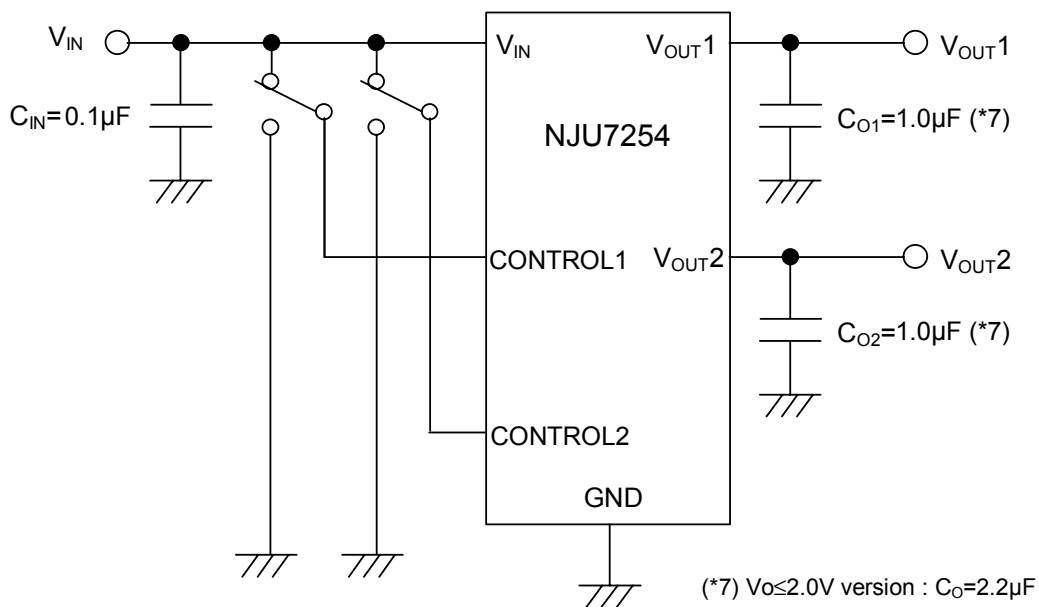

State of control terminal:

- "H" → output is enabled.
- "L" or "open" → output is disabled.

## ■ TYPICAL CHARACTERISTICS

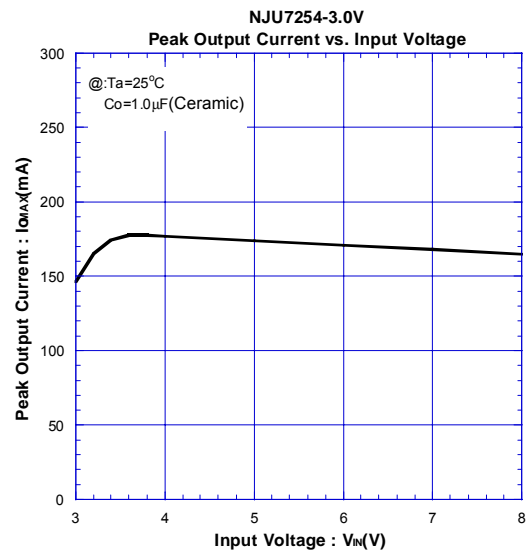
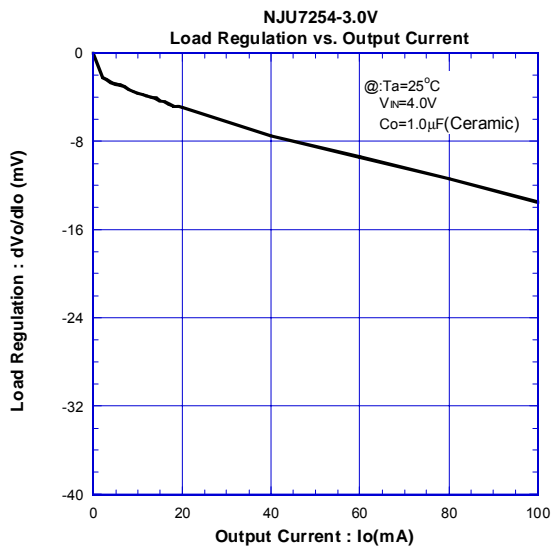
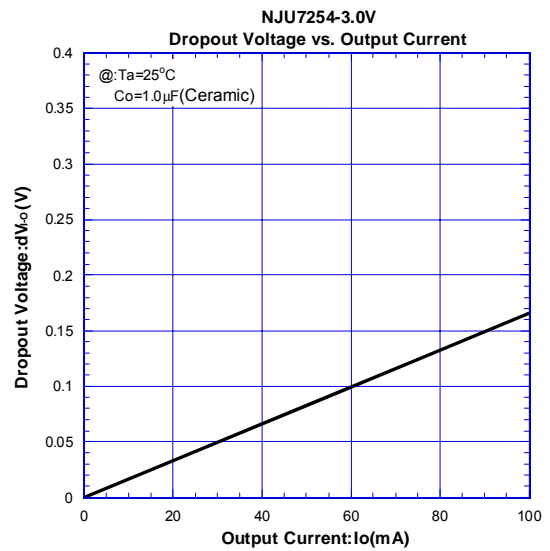
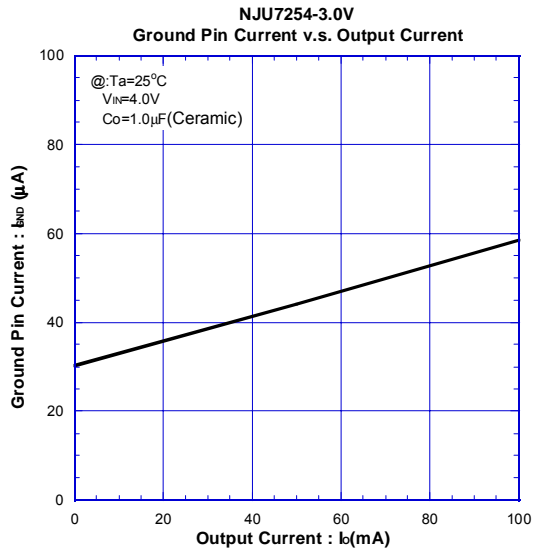
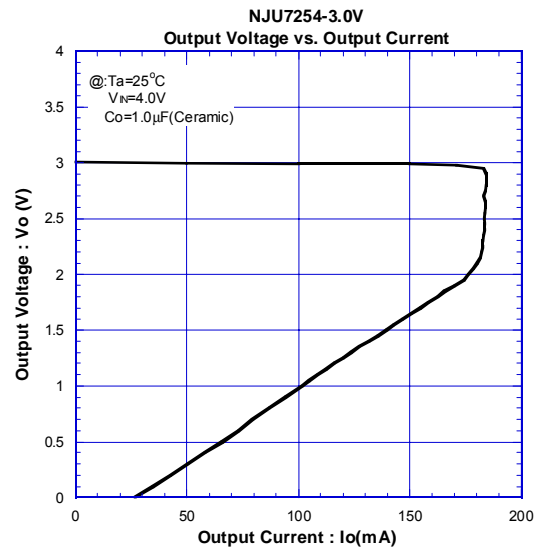
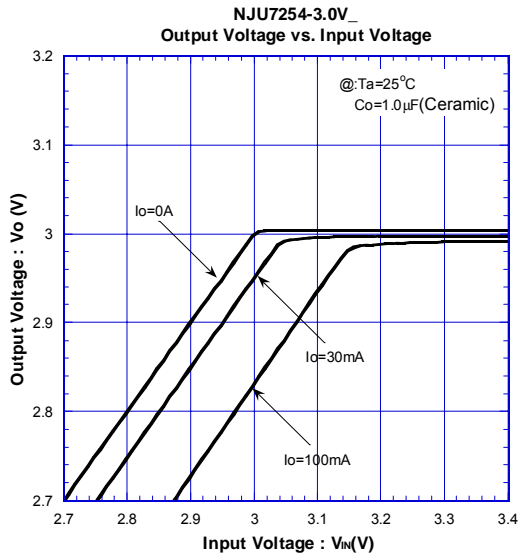

# NJU7254

## ■ TYPICAL CHARACTERISTICS

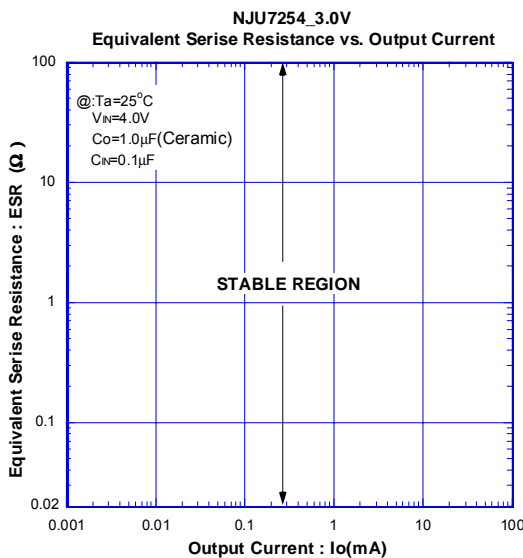
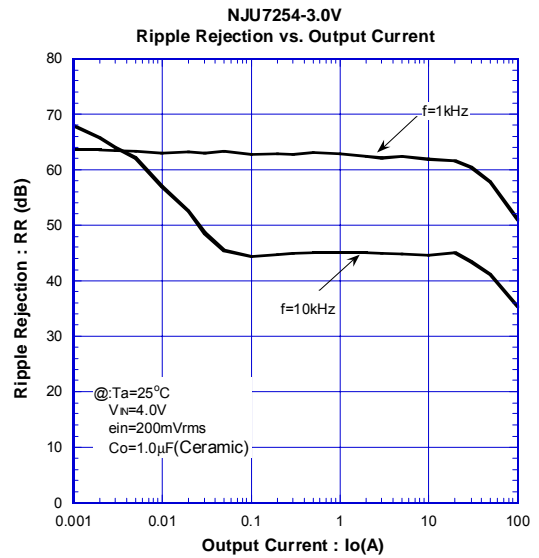
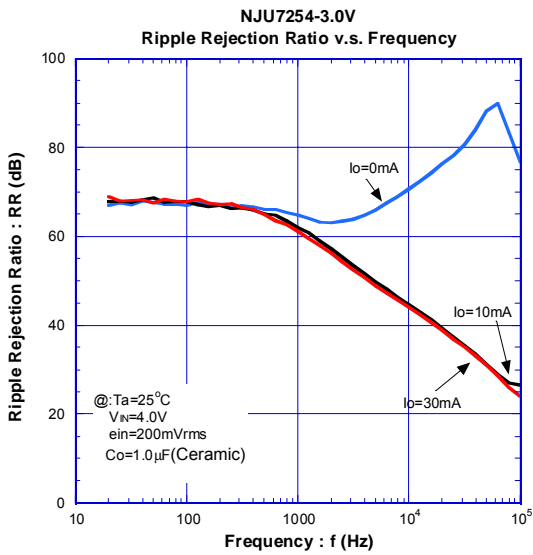
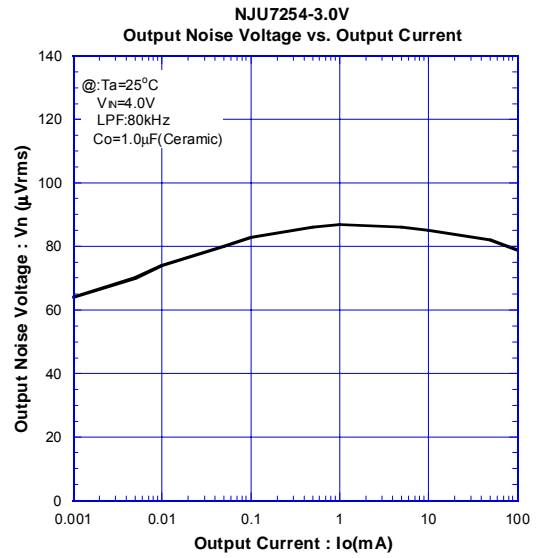
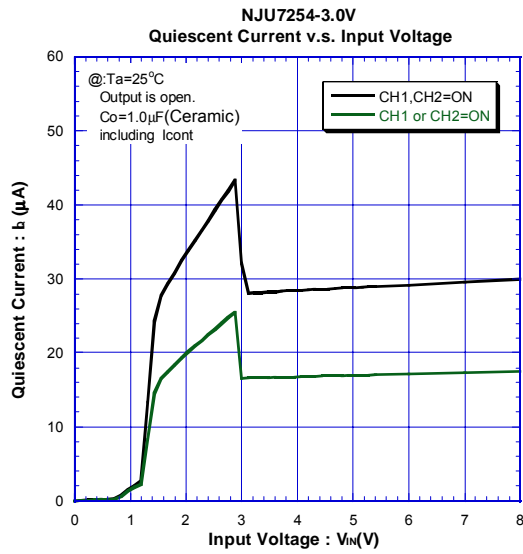

## TYPICAL CHARACTERISTICS

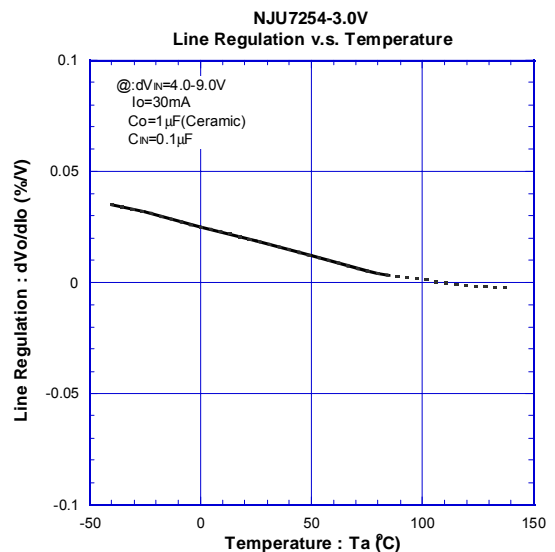
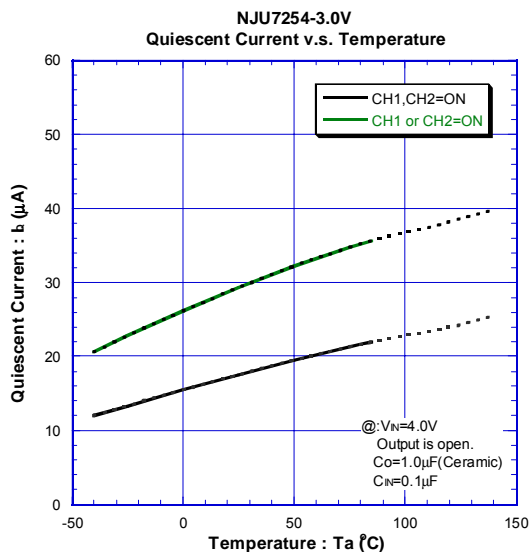
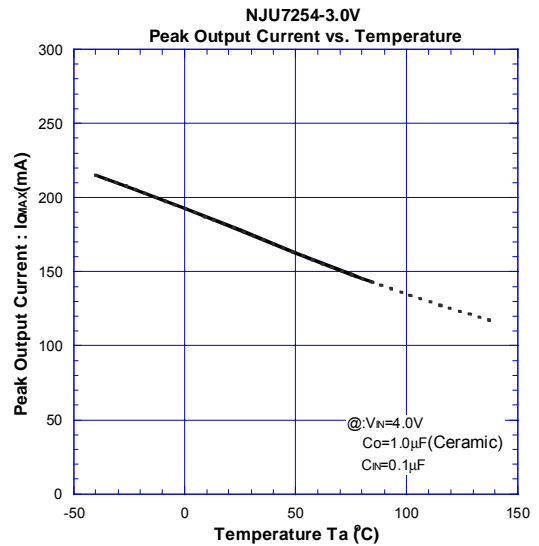
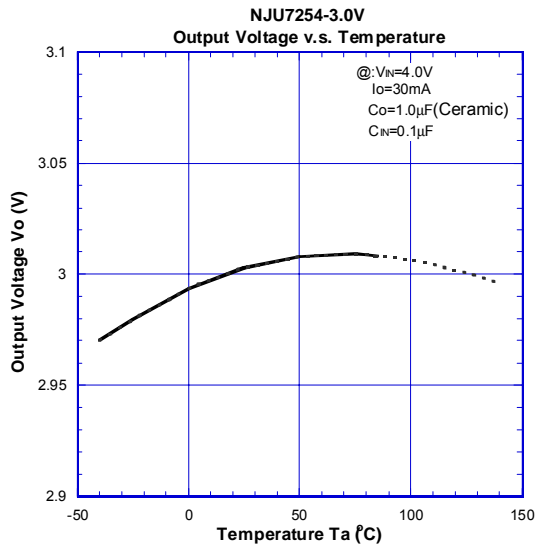
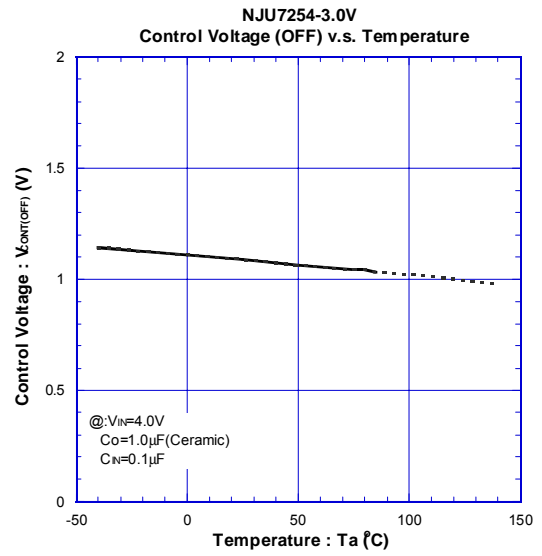
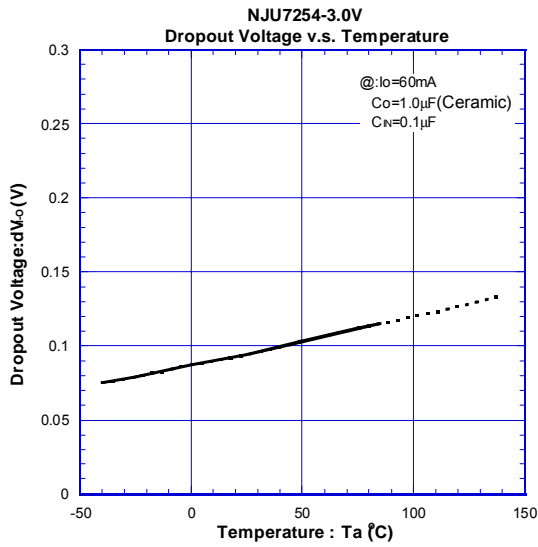

## TYPICAL CHARACTERISTICS

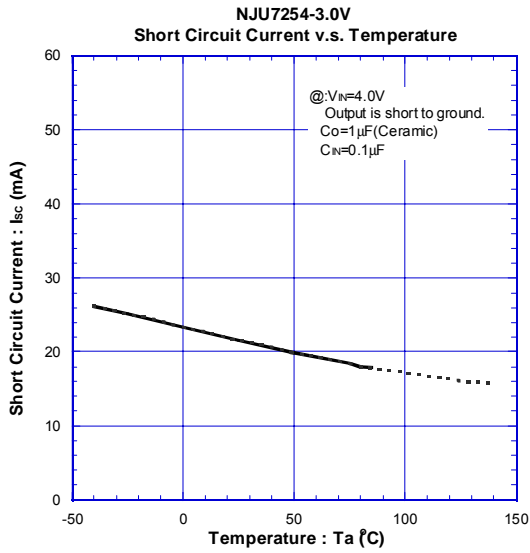
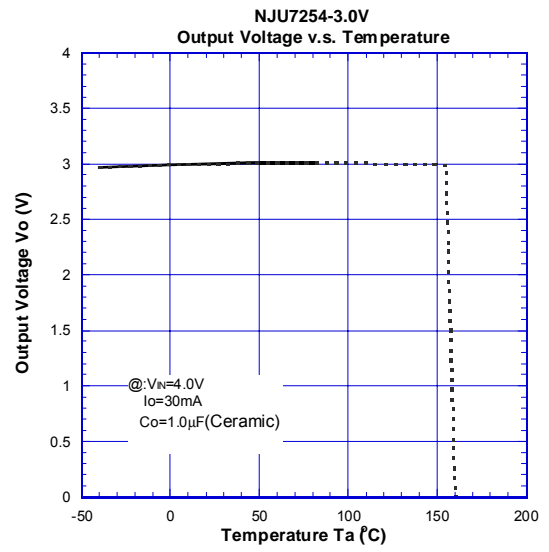
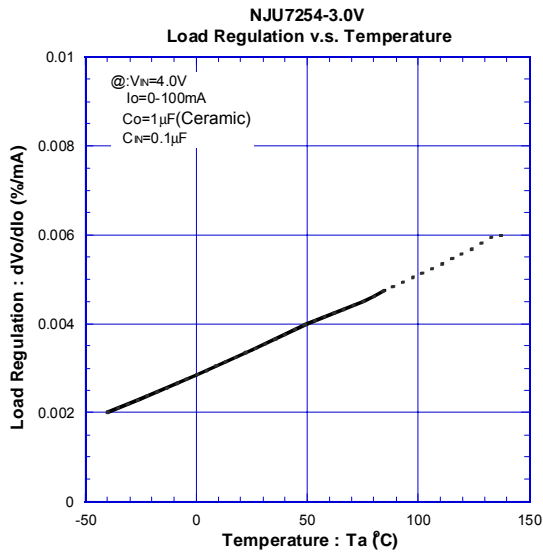



## ■ TYPICAL CHARACTERISTICS

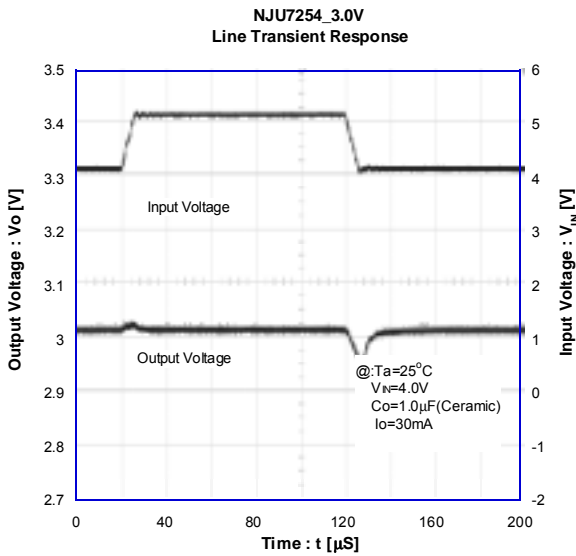
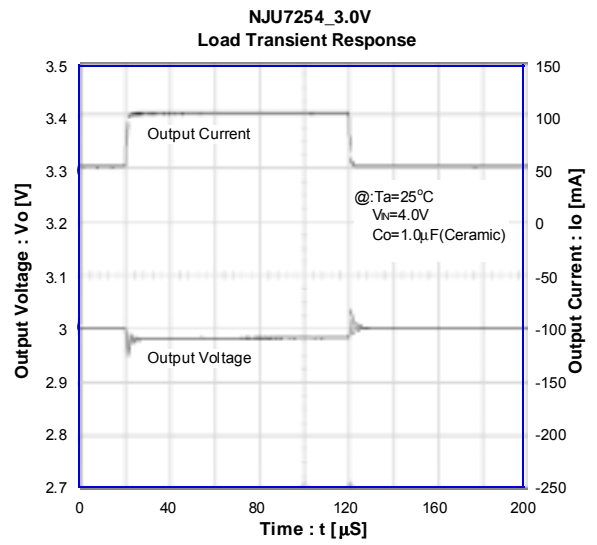
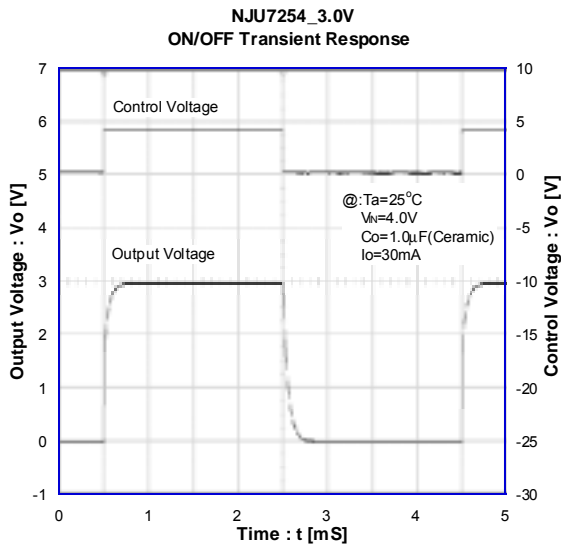

**[CAUTION]**

The specifications on this databook are only given for information, without any guarantee as regards either mistakes or omissions. The application circuits in this databook are described only to show representative usages of the product and not intended for the guarantee or permission of any right including the industrial rights.