

8-CHANNEL ELECTRONIC VOLUME WITH INPUT SELECTOR

■ GENERAL DESCRIPTION

The **NJU72340A** is a 8-channel electronic volume with Input Selector. It includes 8-in 2-out audio selector, REC Output and Multi-channel inputs.

The **NJU72340A** performs low noise and low distortion characteristics with resistance ladder circuit.

All of functions are controlled via two-wired serial bus.

The **NJU72340A** is suitable for multi-channel audio system, such as AV amplifier, DVD receiver, and others.

■ PACKAGE OUTLINE

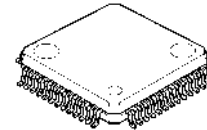

NJU72340AFH3

■ FEATURES

- Operating Voltage ±4.5 to ±7.5V
- 2-Wired Serial Control
- 8-input 2-output selector
- Multi-Channel input (8ch x 1) stereo : 7-input, monaural : 1-input
- Input Selector Gain Control *LBch x2, RBch x2
- Volume Gain : 0,-5,-6,-7,-9,-11,-12,-13dB
- CMOS Technology +31.5 ~ -95dB/0.5dBstep, MUTE
- Package Outline LQFP52-H3

■ BLOCK DIAGRAM

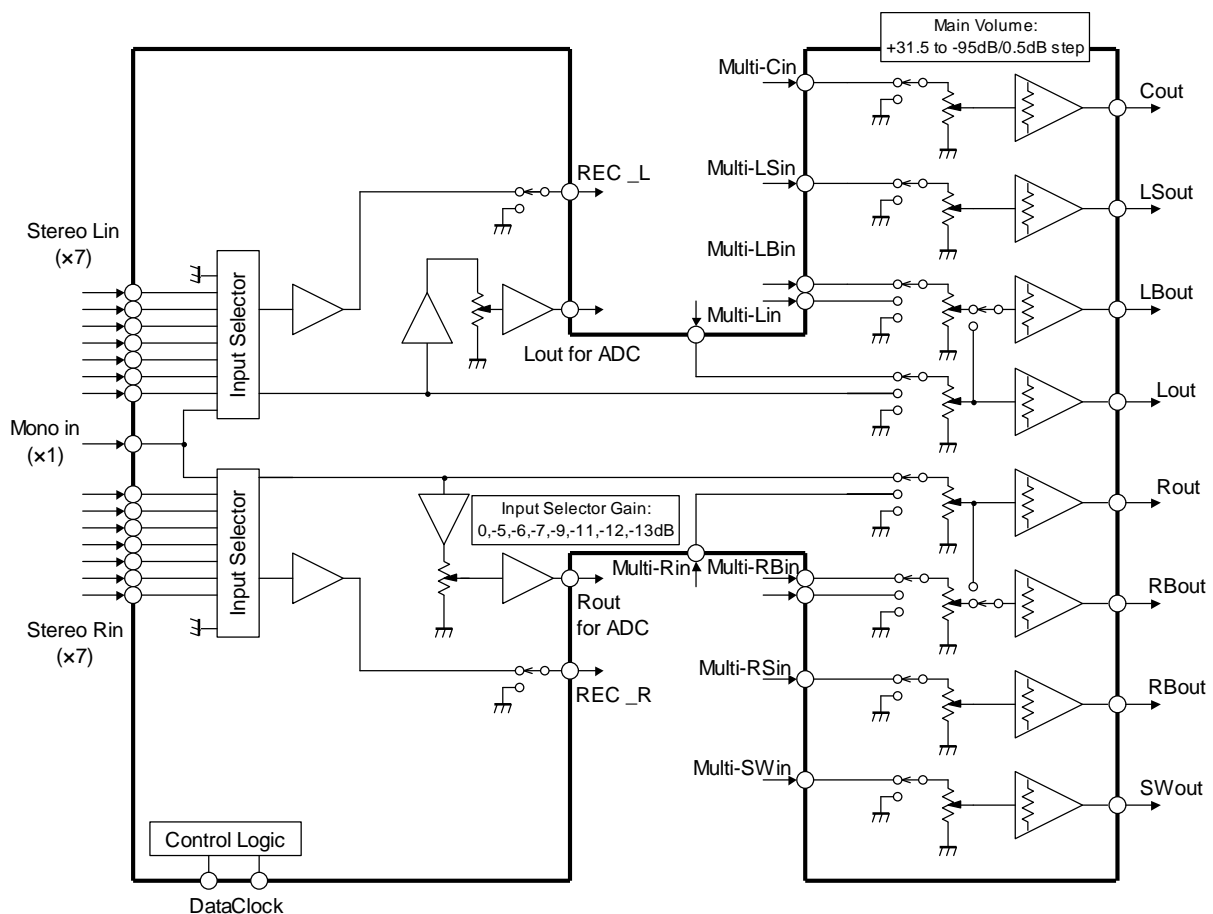

NJU72340A

■ PIN FUNCTION

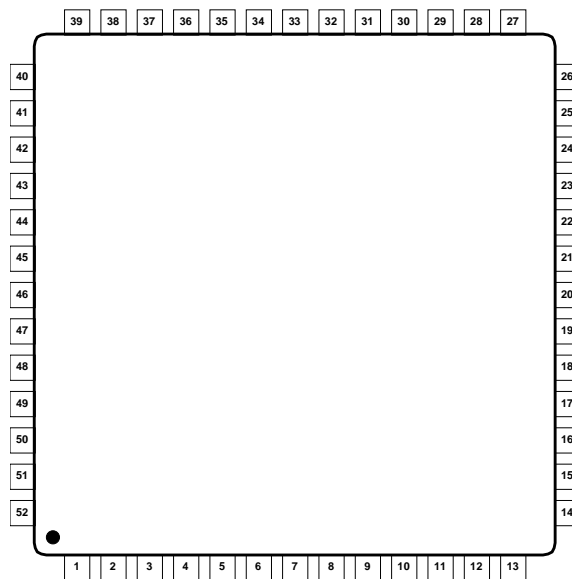

No.	SYMBOL	FUNCTION	No.	SYMBOL	FUNCTION
1	LOUT	Lch output	27	R4IN	"Input selector" Rch input 4
2	ROUT	Rch output	28	L4IN	"Input selector" Lch input 4
3	COUT	Cch output	29	R5IN	"Input selector" Rch input 5
4	LSOUT	LSch output	30	L5IN	"Input selector" Lch input 5
5	RSOUT	RSch output	31	R6IN	"Input selector" Rch input 6
6	LBOUT	LBch output	32	L6IN	"Input selector" Lch input 6
7	RBOUT	RBch output	33	R7IN	"Input selector" Rch input 7
8	SWOUT	SWch output	34	L7IN	"Input selector" Lch input 7
9	DCAP_1	Switching noise rejection capacitor 1	35	DCAP_5	Switching noise rejection capacitor 5
10	DCAP_2	Switching noise rejection capacitor 2	36	MONOIN	Monaural input selector
11	GND	Ground	37	DCAP_6	"Input selector" Lch input 7
12	DATA	Control data signal input	38	ADC_R	Rch output for ADC
13	CLOCK	Clock signal input	39	ADC_L	Lch output for ADC
14	DCAP_3	Switching noise rejection capacitor 3	40	GND	Ground
15	REC_R	"Input selector" Rch REC output	41	LIN	Multi-channel Lch input
16	REC_L	"Input selector" Lch REC output	42	RIN	Multi-channel Rch input
17	GND	Ground	43	CIN	Multi-channel Cch input
18	RB2IN	Multi-channel RBch input 2	44	LSIN	Multi-channel LSch input
19	LB2IN	Multi-channel LBch input 2	45	RSIN	Multi-channel RSch input
20	R1IN	"Input selector" Rch input 1	46	LBIN	Multi-channel LBch input
21	L1IN	"Input selector" Lch input 1	47	RBIN	Multi-channel RBch input
22	R2IN	"Input selector" Rch input 2	48	SWIN	Multi-channel SWch input
23	L2IN	"Input selector" Lch input 2	49	V-	Power Supply (-)
24	R3IN	"Input selector" Rch input 3	50	V+	Power Supply (+)
25	L3IN	"Input selector" Lch input 3	51	DCAP_7	Switching noise rejection capacitor 7
26	DCAP_4	Switching noise rejection capacitor 4	52	DCAP_8	Switching noise rejection capacitor 8

■ ABSOLUTE MAXIMUM RATING (Ta=25°C)

PARAMETER	SYMBOL	RATING	UNIT
Power Supply Voltage	V ⁺ /V ⁻	+8/-8	V
Maximum Input Voltage	V _{IM}	V ⁺ /V ⁻	V
Power Dissipation	P _D	1800 <small>NOTE: EIA/JEDEC STANDARD Test board (76.2x114.3x1.6mm, 2layer, FR-4) mounting</small>	mW
Operating Temperature Range	Topr	-40 to +85	°C
Storage Temperature Range	Tstg	-40 to +125	°C

■ ELECTRICAL CHARACTERISTICS (Ta=25°C, V⁺/V⁻=±7V, RL=47kΩ, Volume=0dB)

PARAMETER	SYMBOL	TEST CONDITION	MIN.	TYP.	MAX.	UNIT
◆ Power Supply						
Operating Voltage	V ⁺ /V ⁻		±4.5	±7.0	±7.5	V
Supply Current 1	I _{CC}	No signal	-	12	25	mA
Supply Current 2	I _{EE}	No signal	-	12	25	mA
◆ Input/Output Characteristics (Output)						
Maximum Output Voltage	V _{OM}	f=1kHz, THD=1% Volume=0dB	3.6	4.2	-	Vrms
Maximum Input Voltage	V _{IM}	f=1kHz, THD=1% Volume=-20dB	4.7	-	-	Vrms
Voltage Gain 1	G _{V1}	V _{IN} =2Vrms, f=1kHz Volume=0dB	-0.5	0	+0.5	dB
Voltage Gain 2	G _{V2}	V _{IN} =100mVrms, f=1kHz Volume=+15dB	+14	+15	+16	dB
Voltage Gain Error	ΔG _V	V _{IN} =2Vrms, f=1kHz Volume=0dB	-0.5	0	0.5	dB
Maximum Attenuation	A _{TT}	f=1kHz, V _{IN} =2Vrms Volume=Mute, A-weight	-	-120	-	dB
Attenuation Error	ΔA _{TT}	f=1kHz, V _{IN} =2Vrms Volume=-60dB	-1	0	1	dB
Output Noise1	V _{NO1}	Volume=0dB, Rg=0, A-weight	-	-117 (1.41μ)	-104 (6.3μ)	dBV (Vrms)
Output Noise2	V _{NO2}	Volume=-95dB, Rg=0, A-weight	-	-117 (1.41μ)	-104 (6.3μ)	dBV (Vrms)
Total Harmonic Distortion 1	T.H.D.1	f=1kHz, V _{IN} =1Vrms, Volume=0dB, BW=400Hz-30kHz	-	0.0004	0.01	%
Total Harmonic Distortion 2	T.H.D.2	f=10kHz, V _{IN} =1Vrms, Volume=0dB, BW=400Hz-30kHz	-	0.0008	-	%
Cross Talk 1	CT1	f=1kHz, V _{IN} =2Vrms, A-weight Volume=0dB, Rg=0Ω	-	-120	-	dB
Cross Talk 2	CT2	f=20kHz, V _{IN} =2Vrms, Volume=0dB, Rg=0Ω	-	-100	-	dB
Channel Separation 1	CS1	f=1kHz, V _{IN} =2Vrms, A-weight Volume=0dB, Rg=0Ω	-	-115	-80	dB
Channel Separation 2	CS2	f=20kHz, V _{IN} =2Vrms, Volume=0dB, Rg=0Ω	-	-90	-	dB

NJU72340A

■ ELECTRICAL CHARACTERISTICS (Ta=25°C, V⁺/V⁻=±7V, RL=47kΩ, Volume=0dB)

PARAMETER	SYMBOL	TEST CONDITION	MIN.	TYP.	MAX.	UNIT
◆ Input/Output Characteristics (REC output)						
REC Out Voltage Gain	G _{VREC}	V _{IN} =2Vrms, f=1kHz	-0.5	0	0.5	dB
REC Out Output Noise	V _{NOREC}	Rg=0Ω, A-weight	-	-114 (2μ)	-	dBV (Vrms)
REC Out Total Harmonic Distortion	T.H.D _{REC}	f=1kHz, V _{IN} =1Vrms, BW=400Hz-30kHz	-	0.0003	0.05	%
REC Out Maximum Attenuation	A _{TTREC}	f=1kHz, V _{IN} =2Vrms REC Out=Mute, A-weight	-	-120	-	dB
◆ Input Selector Gain Control Characteristics						
Input Selector Gain Control Voltage Gain 1	G _{VINC1}	f=1kHz, V _{IN} =2Vrms, Input Selector Gain = 0dB	-1.0	0	+1.0	dB
Input Selector Gain Control Voltage Gain 2	G _{VINC2}	f=1kHz, V _{IN} =2Vrms, Input Selector Gain = -6dB	-7.0	-6.0	-5.0	dB
Input Selector Gain Control Voltage Gain 3	G _{VINC3}	f=1kHz, V _{IN} =2Vrms, Input Selector Gain = -12dB	-13.0	-12.0	-11.0	dB
◆ Logic Control Characteristics						
High Level Input Voltage	V _{IH}	DATA, CLOCK Terminal Input	2.5	-	V ⁺	V
Low Level Input Voltage	V _{IL}	DATA, CLOCK Terminal Input	0	-	1.0	V

APPLICATION CIRCUIT

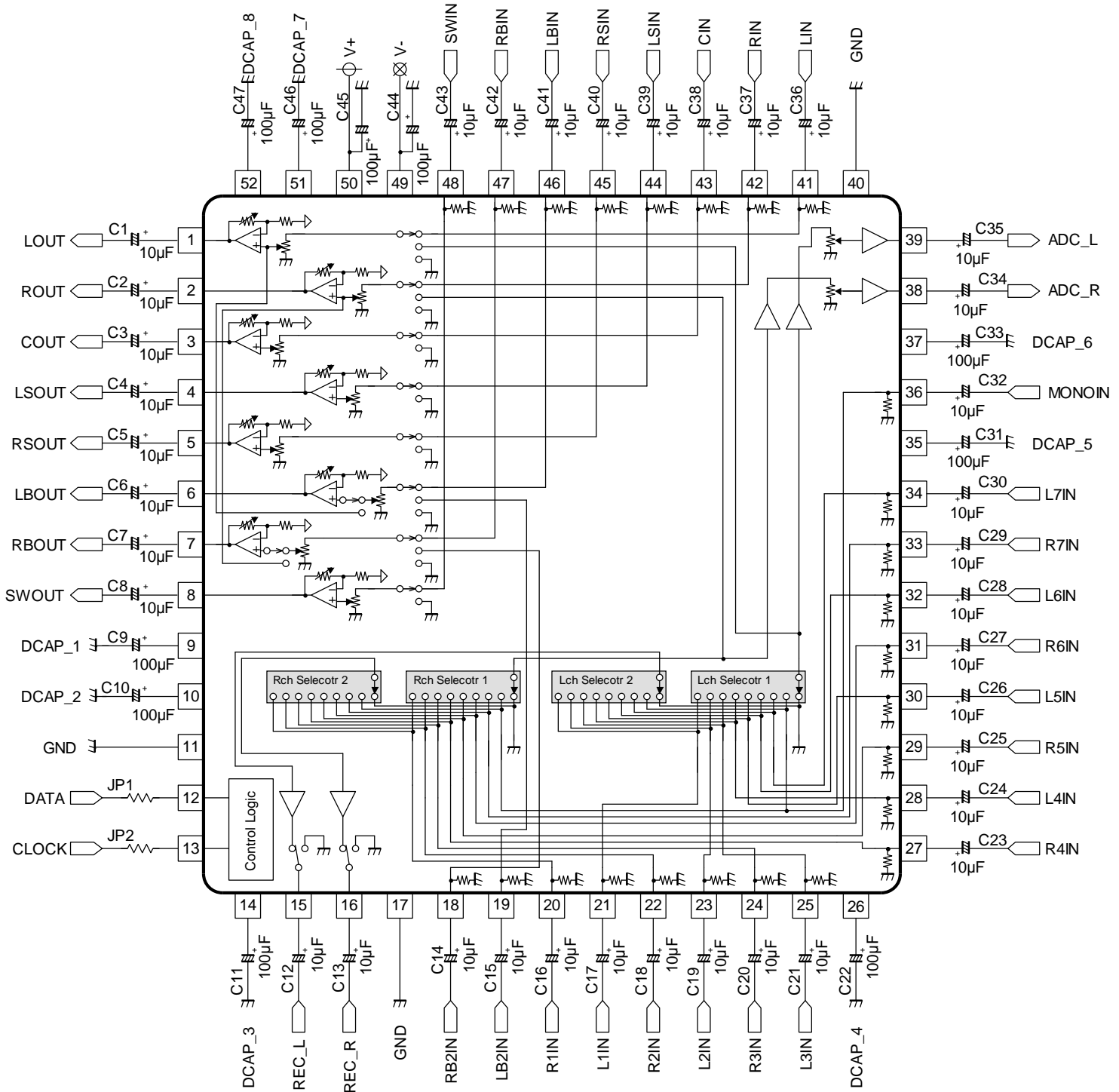

Note.) When switching REC(REC Output) and REC Selector, use MUTE for REC_L pin and REC_R pin on the set. When switching Input Gain and Input Selector, use MUTE for ADC_L pin and ADC_R pin on the set.

■ TIMING ON THE 2-Wire BUS (DATA, CLOCK)

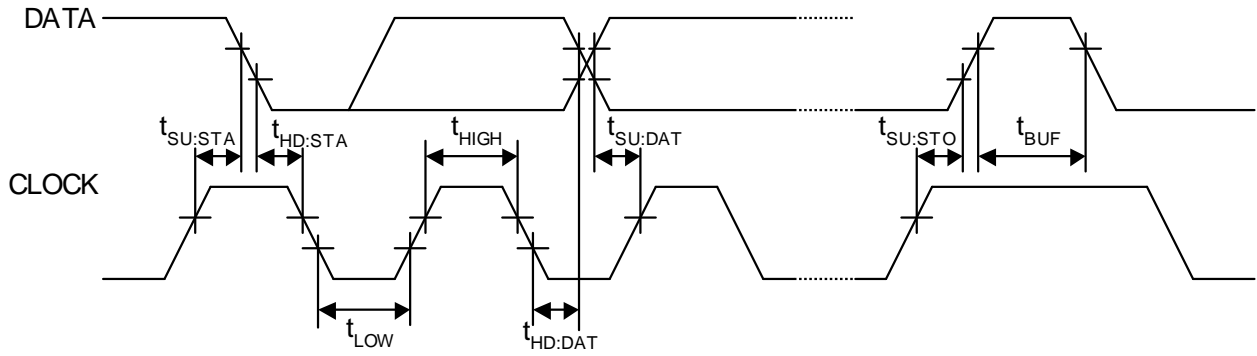

■ CHARACTERISTICS OF I/O STAGES FOR 2-Wire BUS (DATA, CLOCK)

PARAMETER	SYMBOL	MIN.	TYP.	MAX.	UNIT
t_{HD_STA}	Hold time (repeated) START condition.	4	-	-	μs
t_{LOW}	Low period of the SCL clock	2	-	-	μs
t_{HIGH}	High period of the SCL clock	2	-	-	μs
t_{SU_STA}	Set-up time for a repeated START condition	2	-	-	μs
t_{HD_DAT}	Data hold time	300	-	-	ns
t_{SU_DAT}	Data set-up time	200	-	-	ns
t_{SU_STO}	Set-up time for STOP condition	2	-	-	μs
t_{BUF}	Bus free time between a STOP and START condition	4	-	-	μs

■ DEFINITION OF 2-Wire REGISTER

Note) Please don't send except specified data for avoiding an incorrect operation.

◆ 2-Wire BUS FORMAT

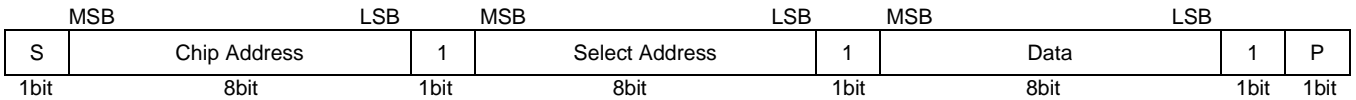

S: Starting Term
P: Ending Term

◆ Chip Address

	MSB											LSB
1	0	0	0	0	1	0	0	0	0	0	0	0

◆ Select Address

The select address sets each function (Volume, Input Gain, Input Selector, Multi Selector, Other Settings).

The auto increment function cycles the select address as follows.

00H→01H→02H→03H→04H→05H→06H→07H→08H→09H→0AH→00H

	MSB	Data								LSB
Select Address	D7	D6	D5	D4	D3	D2	D1	D0		
00H	Lch Volume									
01H	Rch Volume									
02H	Cch Volume									
03H	LSch Volume									
04H	RSch Volume									
05H	LBch Volume									
06H	RBch Volume									
07H	SWch Volume									
08H	Input Gain			REC	Input Selector					
09H	Rec Selector				Cch Selector	SWch Selector	LSch Selector	RSch Selector		
0AH	Lch Selector		Rch Selector		LBch Selector		RBch Selector			

■ CONTROL REGISTER DEFAULT VALUE

	MSB	Data								LSB
Select Address	D7	D6	D5	D4	D3	D2	D1	D0		
00H	0	0	0	0	0	0	0	0		
01H	0	0	0	0	0	0	0	0		
02H	0	0	0	0	0	0	0	0		
03H	0	0	0	0	0	0	0	0		
04H	0	0	0	0	0	0	0	0		
05H	0	0	0	0	0	0	0	0		
06H	0	0	0	0	0	0	0	0		
07H	0	0	0	0	0	0	0	0		
08H	0	0	0	0	0	0	0	0		
09H	0	0	0	0	0	0	0	0		
0AH	0	0	0	0	0	0	0	0		

Note.) This product starts up by MUTE setting in power "ON". Use it after removing MUTE of each setting.

If any audio signal is inputted in input signal terminal before power "ON", it may cause initial condition abnormality.

In conditions of use such as the above, it prevents that abnormality by setting MUTE before power "OFF"

NJU72340A

■ DEFINITION OF RESISTOR

◆Volume Control : +31.5dB to -95dB / 0.5dBstep.

Select Address	Data							
	D7	D6	D5	D4	D3	D2	D1	D0
00H	Lch Volume							
01H	Rch Volume							
02H	Cch Volume							
03H	LSch Volume							
04H	RSch Volume							
05H	LBch Volume							
06H	RBch Volume							
07H	SWch Volume							

< Volume Control Data >

Data								Setting
D7	D6	D5	D4	D3	D2	D1	D0	
0	0	0	0	0	0	0	0	Mute ^(*)
0	0	0	0	0	0	0	1	+31.5dB
0	0	0	0	0	0	1	0	+31.0dB
0	0	0	0	0	0	1	1	+30.5dB
0	0	0	0	0	1	0	0	+30.0dB
0	0	0	0	0	1	0	1	+29.5dB
0	0	0	0	0	1	1	0	+29.0dB
0	0	0	0	0	1	1	1	+28.5dB
0	0	0	0	1	0	0	0	+28.0dB
...								...
0	0	1	1	1	0	0	0	+4.0dB
0	0	1	1	1	0	0	1	+3.5dB
0	0	1	1	1	0	1	0	+3.0dB
0	0	1	1	1	0	1	1	+2.5dB
0	0	1	1	1	1	0	0	+2.0dB
0	0	1	1	1	1	0	1	+1.5dB
0	0	1	1	1	1	1	0	+1.0dB
0	0	1	1	1	1	1	1	+0.5dB
0	1	0	0	0	0	0	0	0dB
0	1	0	0	0	0	0	1	-0.5dB
0	1	0	0	0	0	1	0	-1.0dB
0	1	0	0	0	0	1	1	-1.5dB
0	1	0	0	0	1	0	0	-2.0dB
0	1	0	0	0	1	0	1	-2.5dB
0	1	0	0	0	1	1	0	-3.0dB
0	1	0	0	0	1	1	1	-3.5dB
0	1	0	0	1	0	0	0	-4.0dB
...								...
1	1	1	1	0	0	1	0	-89.0dB
1	1	1	1	0	0	1	1	-89.5dB
1	1	1	1	0	1	0	0	-90.0dB
1	1	1	1	0	1	0	1	-90.5dB
1	1	1	1	0	1	1	0	-91.0dB
1	1	1	1	0	1	1	1	-91.5dB
1	1	1	1	1	0	0	0	-92.0dB
1	1	1	1	1	0	0	1	-92.5dB
1	1	1	1	1	0	1	0	-93.0dB
1	1	1	1	1	0	1	1	-93.5dB
1	1	1	1	1	1	0	0	-94.0dB
1	1	1	1	1	1	0	1	-94.5dB
1	1	1	1	1	1	1	0	-95.0dB
1	1	1	1	1	1	1	1	Mute

(*)Initial Setting

- ◆**Input Gain** : Gain control for selected signal at the Input Selector.
- ◆**REC** : REC Output ON/OFF
- ◆**Input Selector** : Selector for the monaural input and stereo inputs from 1IN to 8IN

Select Address	Data							
	D7	D6	D5	D4	D3	D2	D1	D0
08H	Input Gain			REC	Input Selector			

< Input Selector Gain Control Data >

Data			Setting
D7	D6	D5	
0	0	0	0dB ^(*)
0	0	1	-5dB
0	1	0	-6dB
0	1	1	-7dB
1	0	0	-9dB
1	0	1	-11dB
1	1	0	-12dB
1	1	1	-13dB

<REC ON/OFF Data>

Data	Setting
D4	
0	REC Output OFF ^(*)
1	REC Output ON

< Input Selector Data >

Data				Setting
D3	D2	D1	D0	
0	0	0	0	Mute ^(*)
0	0	0	1	1IN (2ch Input 1)
0	0	1	0	2IN (2ch Input 2)
0	0	1	1	3IN (2ch Input 3)
0	1	0	0	4IN (2ch Input 4)
0	1	0	1	5IN (2ch Input 5)
0	1	1	0	6IN (2ch Input 6)
0	1	1	1	7IN (2ch Input 7)
1	0	0	0	MONOIN (2ch monoral Input 1)

^(*)Initial Setting

NJU72340A

- ◆**REC Selector** : Selector for the 2 channel Input signal to REC output.
- ◆**Cch Selector** : Cch Multi-Channel Selector Data
- ◆**SWch Selector** : SWch Multi-Channel Selector Data
- ◆**LSch Selector** : LSch Multi-Channel Selector Data
- ◆**RSch Selector** : RSch Multi-Channel Selector Data

	MSB									LSB
Select Address	Data									
	D7	D6	D5	D4	D3	D2	D1	D0		
09H	Rec Selector				Cch Selector	SWch Selector	LSch Selector	RSch Selector		

< Rec Selector Data >

Data				Setting
D7	D6	D5	D4	
0	0	0	0	Mute ^(*)
0	0	0	1	1IN (2ch Input 1)
0	0	1	0	2IN (2ch Input 2)
0	0	1	1	3IN (2ch Input 3)
0	1	0	0	4IN (2ch Input 4)
0	1	0	1	5IN (2ch Input 5)
0	1	1	0	6IN (2ch Input 6)
0	1	1	1	7IN (2ch Input 7)
1	0	0	0	MONOIN (2ch monaural Input 1)

<Cch Multi Selector Data>

Data	Setting
D3	
0	MUTE ^(*)
1	Multi-Channel Input

<SWch Multi Selector Data>

Data	Setting
D2	
0	MUTE ^(*)
1	Multi-Channel Input

<LSch Multi Selector Data>

Data	Setting
D1	
0	MUTE ^(*)
1	Multi-Channel Input

<RSch Multi Selector Data>

Data	Setting
D0	
0	MUTE ^(*)
1	Multi-Channel Input

^(*)Initial Setting

- ◆Lch Selector : Lch Multi-Channel Selector Data
- ◆Rch Selector : Rch Multi-Channel Selector Data
- ◆LBch Selector : LBch Multi-Channel Selector Data
- ◆RBch Selector : RBch Multi-Channel Selector Data

	MSB	Data								LSB
Select Address	D7	D6	D5	D4	D3	D2	D1	D0		
0AH	Lch Selector		Rch Selector		LBch Selector		RBch Selector			

<Lch Multi Selector Data>

Data		Setting
D7	D6	
0	0	MUTE ^(*)
0	1	8-Input
1	0	Multi-Channel Input

<Rch Multi Selector Data>

Data		Setting
D5	D4	
0	0	MUTE ^(*)
0	1	8-Input
1	0	Multi-Channel Input

<LBch Multi Selector Data>

Data		Setting
D7	D6	
0	0	MUTE ^(*)
0	1	Multi-Channel Input1
1	0	Multi-Channel Input2
1	1	Lch Output

<RBch Multi Selector Data>

Data		Setting
D7	D6	
0	0	MUTE ^(*)
0	1	Multi-Channel Input1
1	0	Multi-Channel Input2
1	1	Rch Output

^(*)Initial Setting

■ TYPICAL CHARACTERISTICS

ICC vs Supply Voltage
No signal

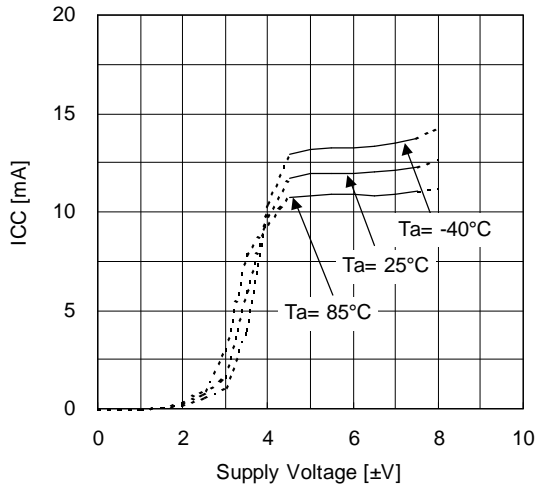

IEE vs Supply Voltage
No signal

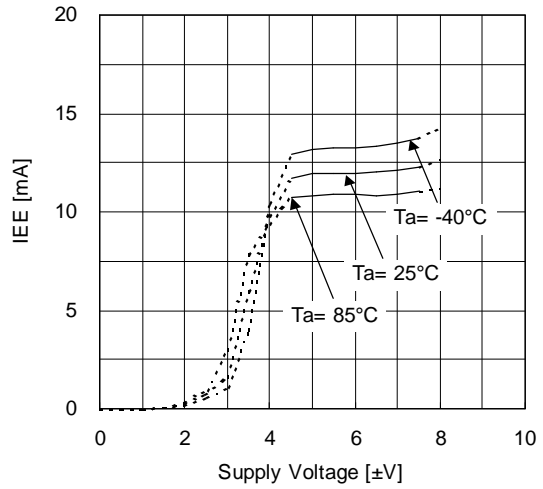

ICC vs Ambient Temperature
No signal

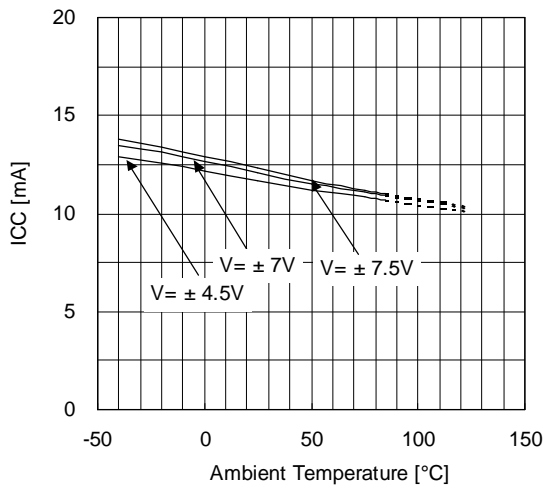

IEE vs Ambient Temperature
No signal

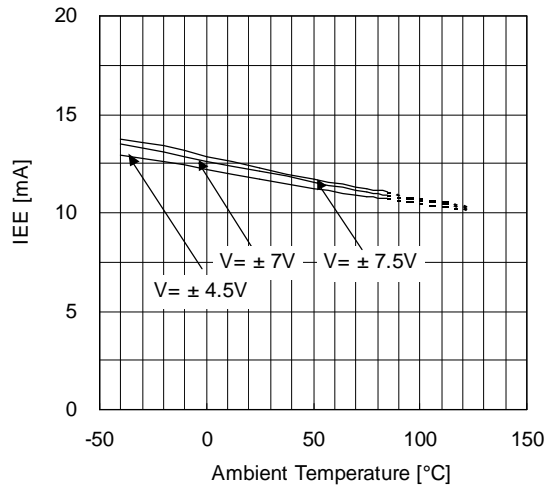

Maximum Output Voltage vs Frequency
V=±7V, THD=1%, VO: LIN-LOUT

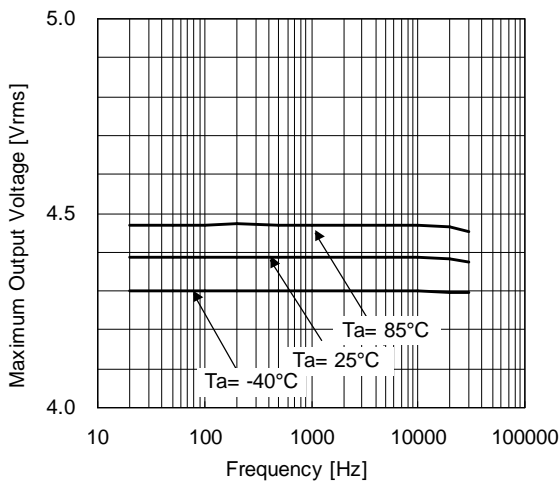

Maximum Output Voltage vs Supply Voltage
f=1kHz, THD=1%, VO: LIN-LOUT

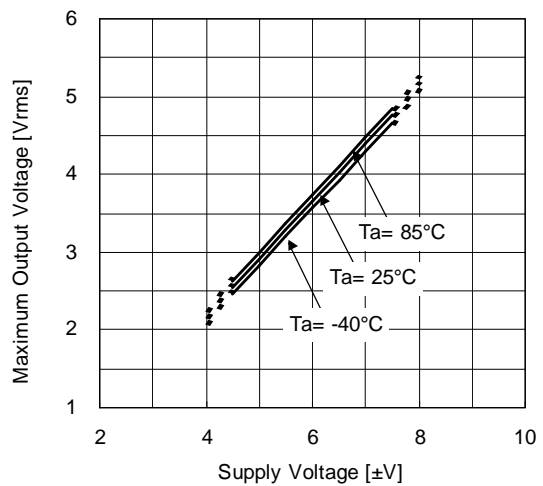

TYPICAL CHARACTERISTICS

Volume Gain output vs Frequency

$V = \pm 7V$, $V_{in} = 2V_{rms}$ (VOL=0, -50, -95dB, Mute),
 $V_{in} = 0.1V_{rms}$ (VOL=+15, +30dB), Bandpass, I/O: LIN-Lout

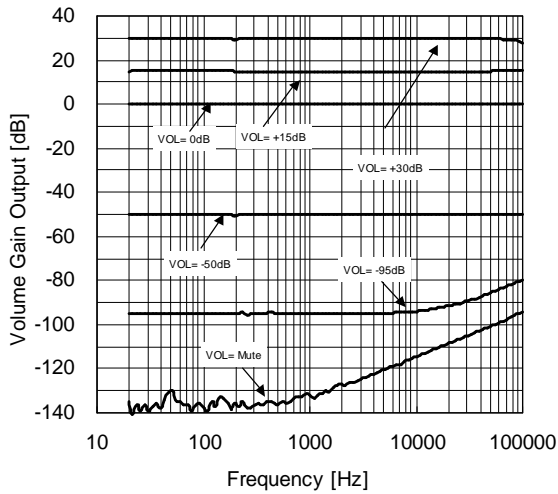

Volume Gain Output vs Volume Setting

$V = \pm 7V$, $f = 1kHz$, Bandpass, I/O: LIN-LOUT

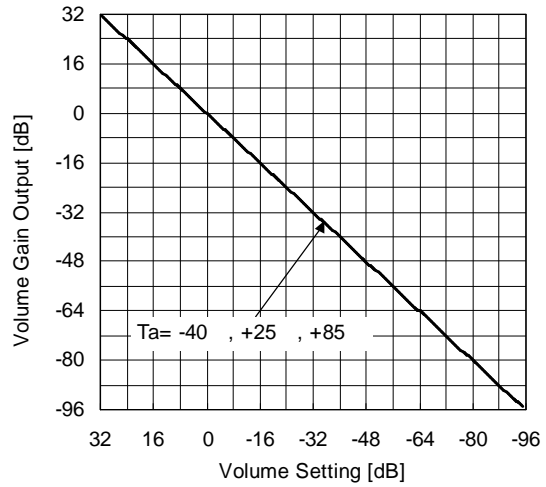

THD+N vs Input Voltage

$V = \pm 7V$, BW: 10-22kHz ($f = 20Hz$), 400-30kHz ($f = 1kHz$),
 400-80kHz ($f = 20kHz$), I/O: LIN-LOUT

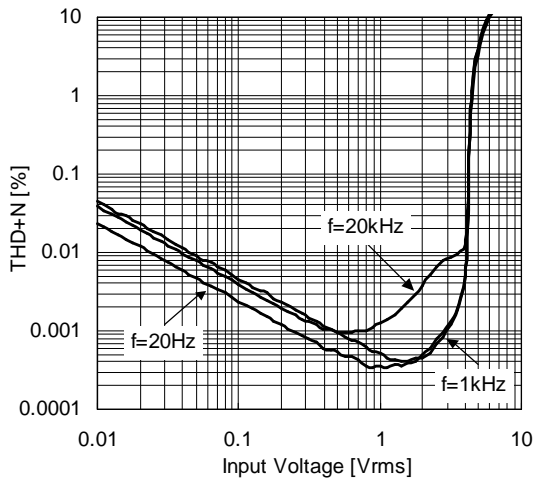

THD+N vs Input Voltage

$V = \pm 7V$, $f = 1kHz$, BW: 400-30kHz, I/O: LIN-LOUT

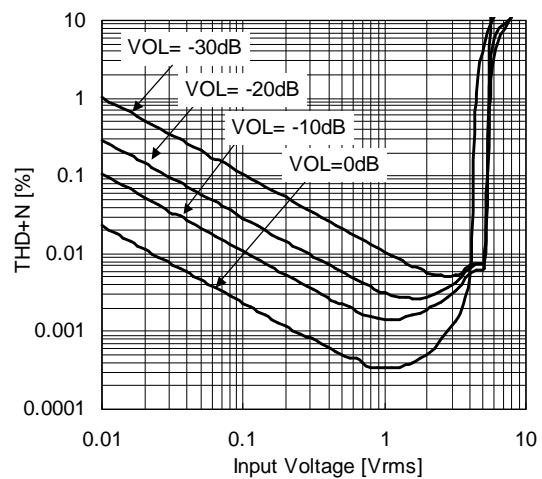

THD+N vs Ambient Temperature

$V = \pm 7V$, $V_{in} = 1V_{rms}$, $f = 1kHz$, BW: 400-30kHz,
 I/O: LIN-Lout

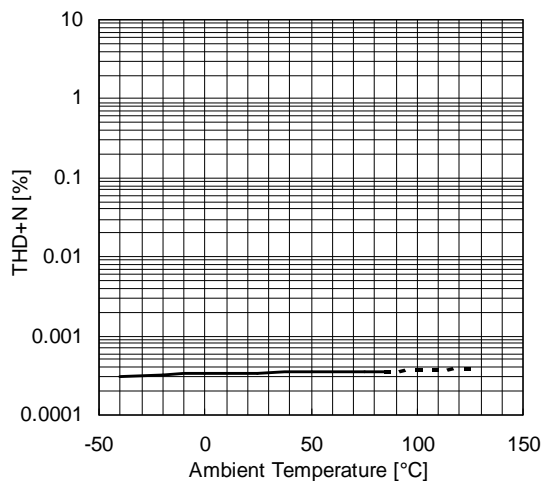

THD+N vs Frequency

$V = \pm 7V$, VOL=0dB, BW: 10-80kHz, I/O: LIN-LOUT

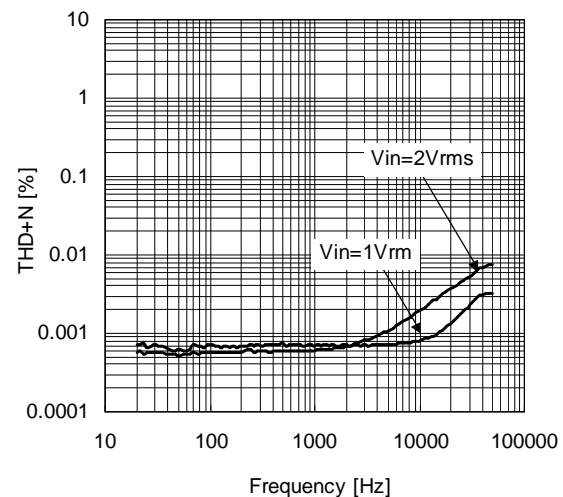

TYPICAL CHARACTERISTICS

Output Noise Voltage vs Ambient Temperature
 $V = \pm 7V$, $R_g = 0\Omega$, $VOL = 0dB$, A-Weighted

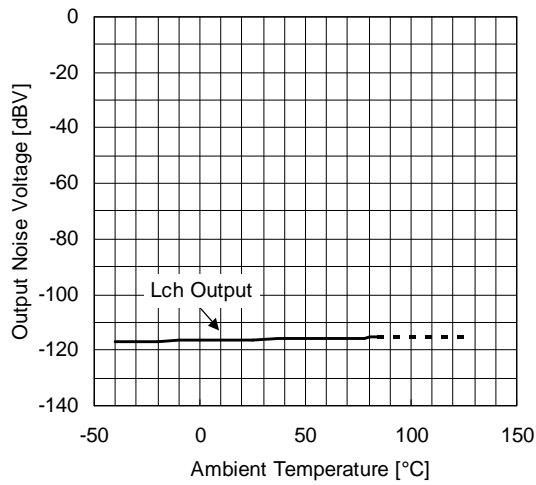

Output Voltage vs Load Resistance
 $V = \pm 7V$, $f = 1kHz$, $V_{in} = 4.2V_{rms}$, $VOL = 0dB$

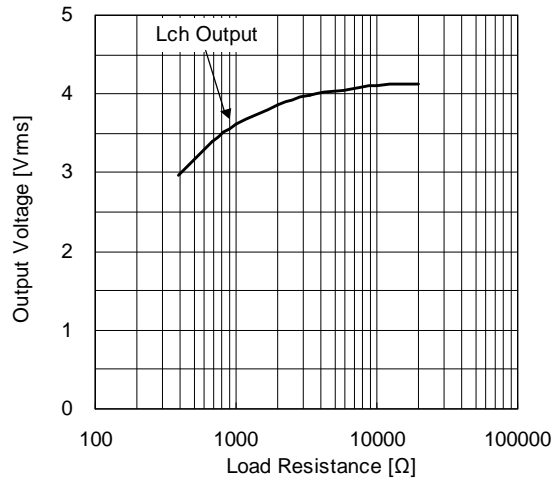

Channel Separation vs Frequency
 $V = \pm 7V$, $V_{in} = 2V_{rms}$, $VOL = 0dB$, $BW: 10-80kHz$,
 $IO: R1IN-LOUT$

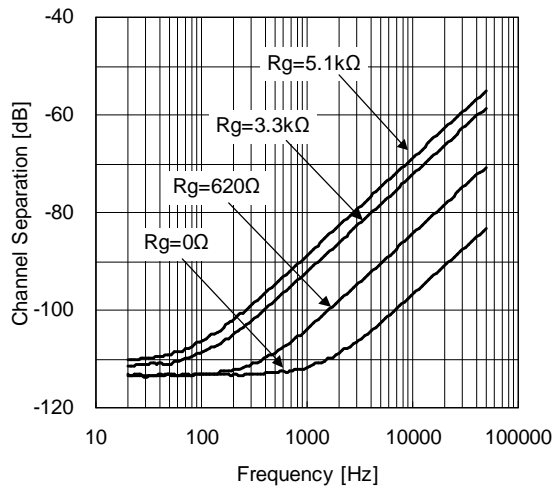

Cross Talk vs Frequency
 $V = \pm 7V$, $V_{in} = 2V_{rms}$, $VOL = 0dB$, $BW: 10-80kHz$,
 $IO: L1IN, L3IN-LOUT$, Select Channel: 2ch

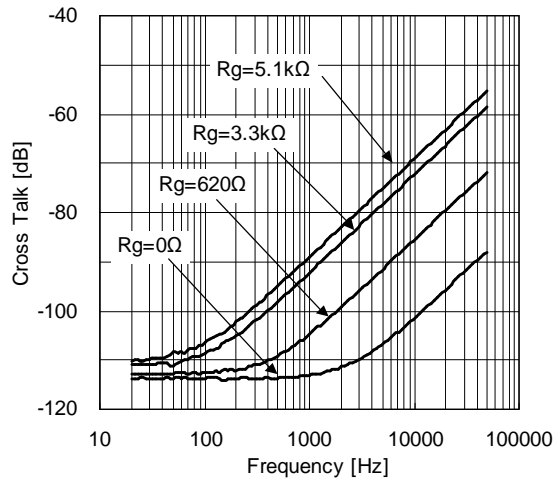

[CAUTION]

The specifications on this databook are only given for information, without any guarantee as regards either mistakes or omissions. The application circuits in this databook are described only to show representative usages of the product and not intended for the guarantee or permission of any right including the industrial rights.