

## Seat Positioning Surround Decoder

### ■ Package

### ■ General Description

The NJU26125 is a high performance 24-bit digital signal processor.  
 The NJU26125 provides NJRC Original Car Surround technology.  
 These kinds of sound functions are suitable for Car Audio that has four channel output speakers.



### ■ FEATURES

NJU26125VC2

#### - Software

- Seat Positioning Surround
  - Car Surround
  - Elevation
  - Bass Enhance
- Input Trimmer
- 7 Band PEQ: PEQ, LPF, HPF, LSF, HSF
- Filter: HPF(SDO0/SDO1), LPF(SDO2)
- Simulated Stereo
- Master Volume & Channel Trimmer
- Navigation Voice Mix Trimmer

#### - Hardware

- 24bit Fixed-point Digital Signal Processing
- Maximum System Clock Frequency : 12.288MHz Max. built-in PLL Circuit
- Digital Audio Interface : 3 Input ports / 3 Output ports
- Digital Audio Format : I<sup>2</sup>S 24bit, Left- justified, Right-justified, BCK : 32/64fs
- Master / Slave Mode
  - Master Mode, MCK : 384fs @32kHz, 256fs @48kHz
- Host Interface : I<sup>2</sup>C bus (Fast-mode/400kbps)
- Power Supply : 3.3V
- Input terminal : 5V Input tolerant
- Package : SSOP24-C2 (Pb-Free)

## Function Block Diagram

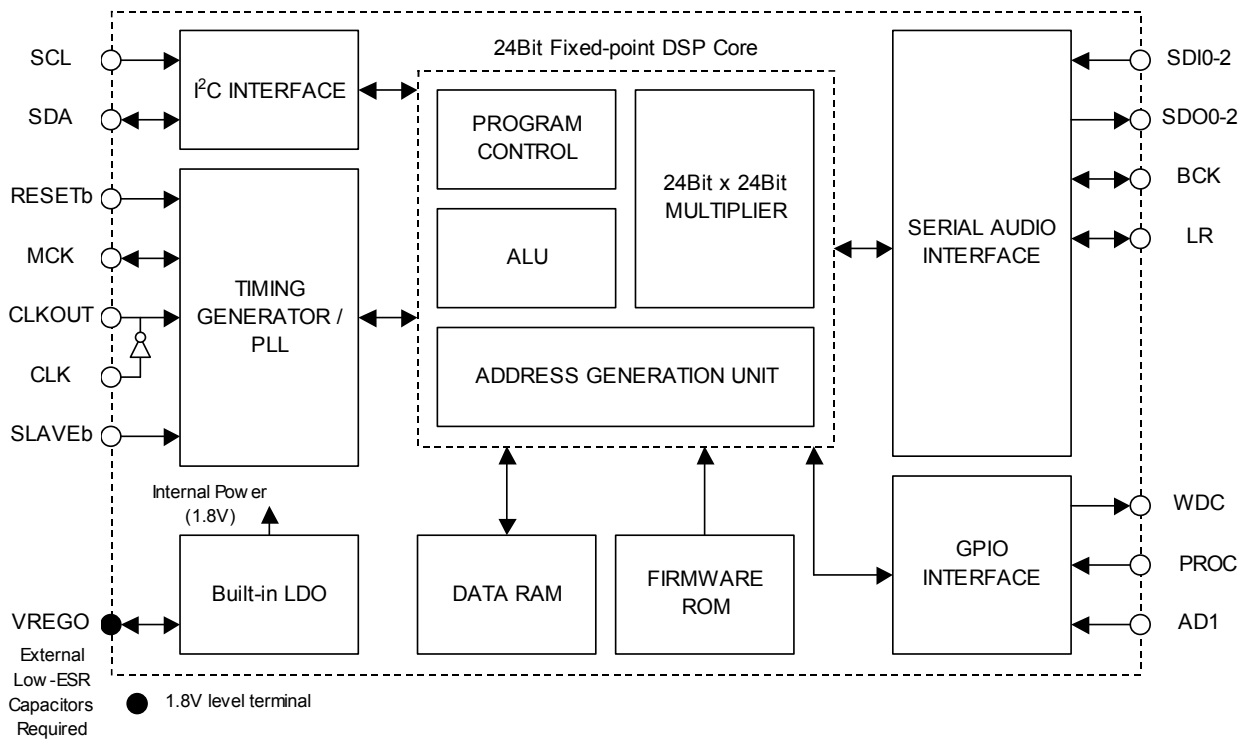

**Fig. 1 NJU26125 Block Diagram**

**DSP Block Diagram**

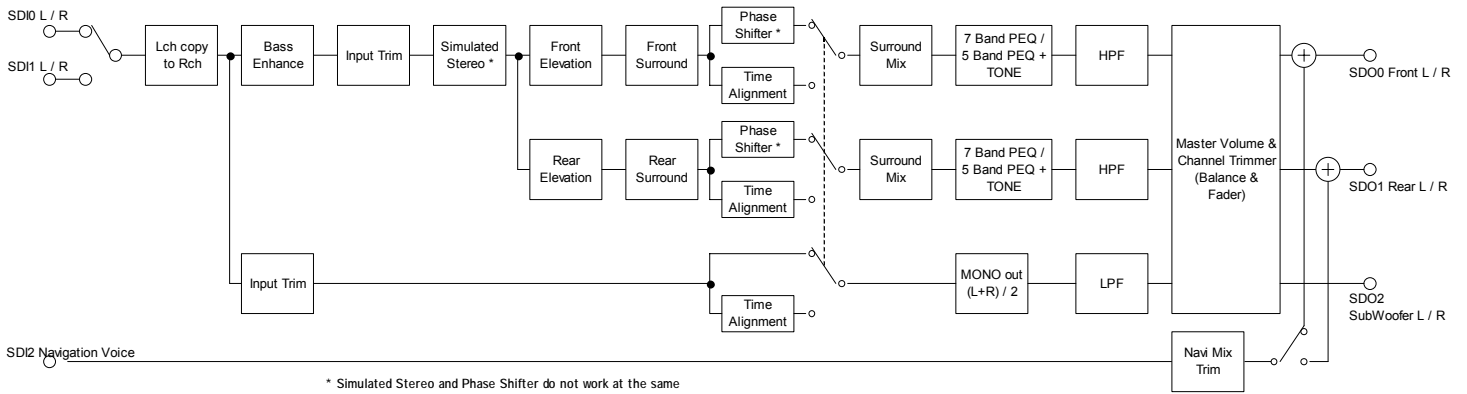

**Fig. 2 NJU26125 Function Diagram**

## Pin Configuration

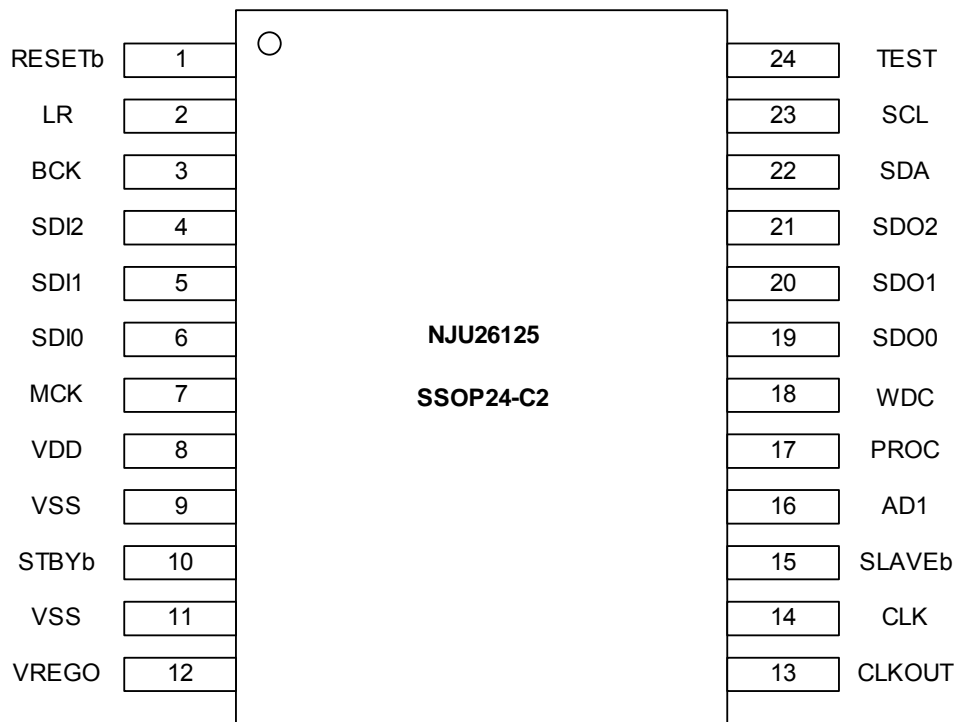

Fig. 3 NJU26125 Pin Configuration

## Pin Description

Table 1 Pin Description

No.	Symbol	I/O	Description
1	RESETb	I	RESET (active Low)
2	LR	I/O	LR Clock
3	BCK	I/O	Bit Clock
4	SDI2	I	Audio Data Input 2 Navi Voice
5	SDI1	I	Audio Data Input 1 L/R
6	SDI0	I	Audio Data Input 0 L/R
7	MCK	I/O	Master Clock
8	VDD	-	Power Supply +3.3V
9	VSS	-	GND
10	STBYb	I	For TEST (Connected to VDD)
11	VSS	-	GND
12	VREGO	PI	Built-in Power Supply Bypass

No.	Symbol	I/O	Description
13	CLKOUT	O	OSC Output
14	CLK	I	OSC Clock Input
15	SLAVEb	I	Slave select
16	AD1	I	I <sup>2</sup> C Address
17	PROC	I	Status select after Reset DSP
18	WDC	OD	Clock for Watch Dog Timer
19	SDO0	O	Audio Data Output 0 Front L/R
20	SDO1	O	Audio Data Output 1 Rear L/R
21	SDO2	O	Audio Data Output 2 Subwoofer
22	SDA	OD	I <sup>2</sup> C I/O
23	SCL	I	I <sup>2</sup> C Clock
24	TEST	I	For TEST(Connected to VSS)

\* I : Input, O : Output, I/O: Bi-directional, OD: Open-Drain I/O, PI: Power Supply Bypass

AD1 (No.16) pin and PROC (No.17) pin are input pins. WDC (No.18) pin is open-drain pin with pull-up resistance. However, these pins operate as bi-directional pins. No.16pin and No.17pin connect with V<sub>DD</sub> or V<sub>SS</sub> through 3.3kΩ resistance. No.18pin do not connect or connect with V<sub>DD</sub> through 3.3kΩ resistance when unused.

VREGO (No.12) pin is a built-in power supply bypass pin. Connect low-ESR capacitor of 4.7μF and 0.01μF in parallel between VSS (No.11) pin. A built-in power supply is used only for NJU26125 operation. Be not short-circuited of this pin. Do not take out the current, and connect other power supplies.

Do not open the terminals without pull-up resistance and pull-down resistance.

■ Absolute Maximum Ratings

Table 2 Absolute Maximum Ratings (V<sub>SS</sub>=0V=GND, Ta=25°C)

Parameter	Symbol	Rating	Units
Supply Voltage *	V <sub>DD</sub>	-0.3 to 4.2	V
Supply Voltage Bypass *	V <sub>REGO</sub>	-0.3 to 2.3	V
Pin Voltage *	In	V <sub>x(IN)</sub>	-0.3 to 5.5 (V <sub>DD</sub> ≥ 3.0V) -0.3 to 4.2 (V <sub>DD</sub> < 3.0V)
	I/O, OD	V <sub>x(I/O)</sub> , V <sub>x(OD)</sub>	
	Out	V <sub>x(OUT)</sub>	-0.3 to 4.2
	CLK	V <sub>x(CLK)</sub>	
	CLKOUT	V <sub>x(CLKOUT)</sub>	
Power Dissipation	P <sub>D</sub>	565	mW
Operating Voltage	T <sub>OPR</sub>	-40 to 85	°C
Storage Temperature	T <sub>STR</sub>	-40 to 125	°C

\* The LSI must be used inside of the "Absolute maximum ratings". Otherwise, a stress may cause permanent damage to the LSI.

- \* V<sub>DD</sub> : 8 pin
- \* V<sub>REGO</sub> : 12 pin
- \* V<sub>x(IN)</sub> : 1, 4, 5, 6, 10, 15, 23, 24 pin
- \* V<sub>x(OD)</sub> : 22 pin
- \* V<sub>x(I/O)</sub> : 2, 3, 7, 16, 17, 18 pin
- \* V<sub>x(OUT)</sub> : 19, 20, 21 pin
- \* V<sub>x(CLK)</sub> : 14 pin
- \* V<sub>x(CLKOUT)</sub> : 13 pin

■ Terminal equivalent circuit diagram

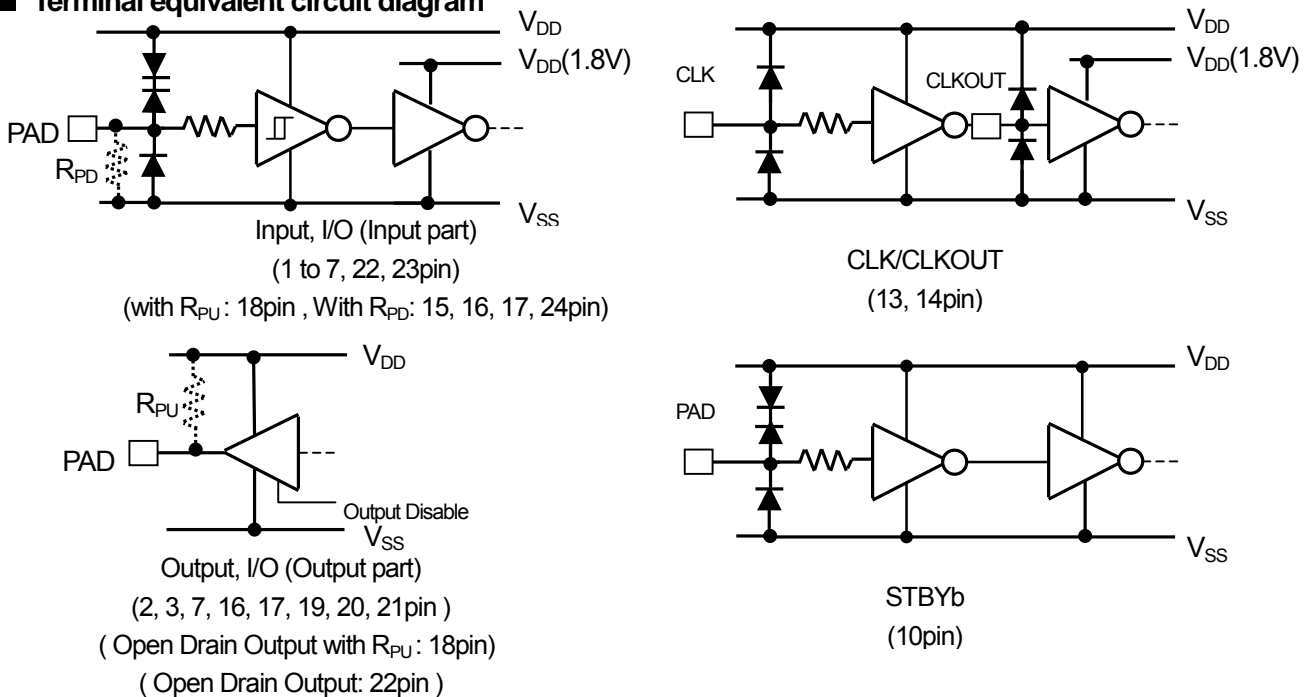

Fig.4 NJU26125 Terminal equivalent circuit diagram

## ■ Electric Characteristics

**Table 3 Electric Characteristics**

( $V_{DD}=3.3V, f_{OSC}=12.288MHz, T_a=25^{\circ}C$ )

Parameter	Symbol	Test Condition	Min.	Typ.	Max.	Units
Operating Voltage <sup>*1</sup>	$V_{DD}$	$V_{DD}$ pin	3.0	3.3	3.6	V
Operating Current	$I_{DD}$	At no load	-	20	35	mA
High Level Input Voltage	$V_{IH}$		$V_{DD} \times 0.7$	-	$V_{DD}$ <sup>*2</sup>	V
Low Level Input Voltage	$V_{IL}$		0	-	$V_{DD} \times 0.3$	
High Level Output Voltage <sup>*3</sup>	$V_{OH}$	( $I_{OH} = -1mA$ )	$V_{DD} \times 0.8$	-	$V_{DD}$	
Low Level Output Voltage	$V_{OL}$	( $I_{OL} = 1mA$ )	0	-	$V_{DD} \times 0.2$	
Leakage Current <sup>*4</sup>	$I_{IN}$	$V_{IN} = V_{SS}$ to $V_{DD}$	-10	-	10	$\mu A$
	$I_{IN(PU)}$		-120	-	10	
	$I_{IN(PD)}$		-10	-	120	
Clock Frequency	$f_{OSC}$	CLK, MCK <sup>*6</sup>	10	12.288	13	MHz
Clock Jitter <sup>*5</sup>	$f_{JIT(CC)}$		0	-	3.0	ns
Clock Duty Cycle	$\Gamma_{EC}$		45	50	55	%

\*1 Please use the  $V_{DD}$  within the electric characteristics.  $V_{DD}$  is monotonous increase. Don't drop voltage under the electric characteristics after booting  $V_{DD}$  to regulation voltage. When it turns off DSP and turns on DSP again, it is necessary to drop  $V_{DD}$  to GND level. Then it turns on DSP again.

\*2 Input pin, Output pin and Open-Drain input/output pin are +5.0V tolerant except CLK input pin.

\*3 Except No.18pin: WDC (Open-Drain output) and No.22: SDA (Open-Drain input/output).

\*4  $I_{IN(PU)}$ : 18pin,  $I_{IN(PD)}$ : 15, 16, 17, 24 pin

\*5 Clock Jitter shows Cycle-to-cycle period jitter (JEDEC JESD65).

\*6 Provide clock frequency for  $f_{OSC}$  spec. NJU26125 needs clock frequency 12.288MHz when sampling rate is 48kHz.

## 1. Power Supply, Input/Output terminal, Clock, Reset

### 1.1 Power Supply

The NJU26125 has a power supply  $V_{DD}$ . To setup good power supply condition, the decoupling capacitors should be implemented at the all power supply terminals.

The NJU26125 include a built-in power supply (LDO) for internal logic. A built-in power supply generates 1.8V (-10% to +10%). VREGO (No.12) pin is a built-in power supply bypass pin. Connect low-ESR capacitor of 4.7 $\mu$ F and 0.01 $\mu$ F in parallel between VSS (No.11) pin.

A built-in power supply is used only for NJU26125 operation. Be not short-circuited of this pin. Do not take out the current, and connect other power supplies.

### 1.2 Input/Output terminal

It restricts, when the input terminals (AD1, PROC, RESETb, SDI0, SDI1, SDI2, STBYb, SLAVEb, SCL, TEST pins), the input/output terminals (LR, BCK, MCK pins) and the bi-directional Open-drain terminal (SDA pin) of NJU26125, and  $V_{DD}$  are supplied on regular voltage ( $V_{DD}=3.3V$ ), and it becomes +5V Input tolerant.

### 1.3 Clock

The NJU26125 CLK pin requires the system clock that should be related to the sample frequency 256 Fs.

(For example : Fs=48kHz CLK=12.288MHz )

It is possible to be generated the system clock by connecting a crystal oscillator between CLK and CLKOUT. CLK/CLKOUT pins are not 5V tolerant, so check the voltage level of these pins.

When SLAVEb pin is fixed on Low level, NJU26125 supplies the system clock from MCK pin. Fix the clock input pin not used to Low level because either the CLK pin or the MCK pin is supplied in NJU26125.

The frequency divider for Master mode matched to the clock 256 times of Fs is installed in NJU26125. When clock except 256 times of Fs is used by Master mode, be careful to use because a dividing frequency of Master mode changes. Please check enough and decide parameter.

## 1.4 Reset

To initialize the NJU26125, RESETb pin should be set Low level during some period. After some period of Low level, RESETb pin should be High level. This procedure starts the initialization of the NJU26125. After the power supply and the oscillation of the NJU26125 becomes stable, RESETb pin must be kept Low-level more than  $t_{RESETb}$  period. (Fig.5)

After RESETb pin level goes to "High" (after reset release), a setup of the internal hardware of a Serial Host Interface completes NJU26125 within 10msec. Then, it will be in the state which can communicate.

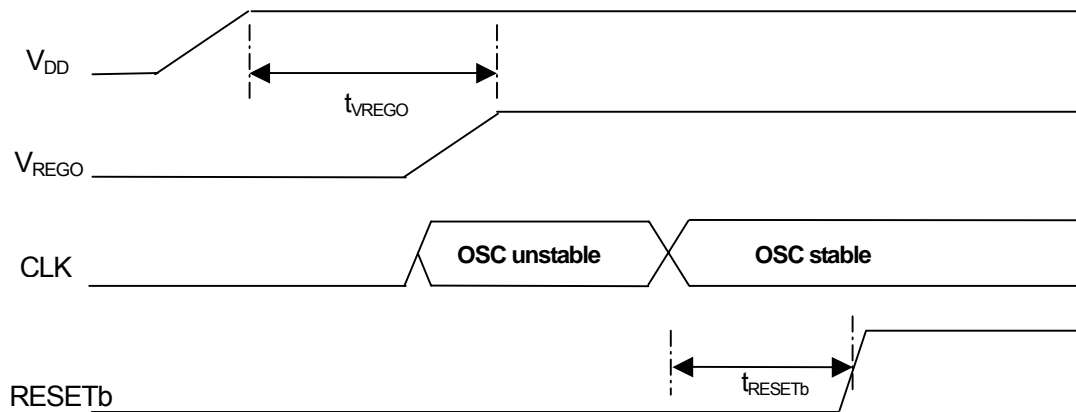

**Fig.5 Reset Timing**

**Table 4 Reset Time**

Symbol	Time
$t_{VREGO}$	$\geq 10\text{msec}$
$t_{RESETb}$	$\geq 1.0\text{msec}$

**Note :**

Don't stop the supply of a clock while operating. NJU26125 installs PLL circuit internally. If the supply of a clock is stopped, PLL circuit cannot be sent a clock to the inside and NJU26125 does not operate normally.

If supply of a clock is stopped or the NJU26125 is reset again, putting a normal clock into CLK terminal, the period RESETb terminal of  $t_{RESETb}$  is kept "Low" level.(Table 4) Next, the NJU26125 is reset. Then redo from initial setting.



## 2. Digital Audio Clock

Digital audio data needs to synchronize and transmit between digital audio systems. The NJU26125 - master mode / slave mode - both of the modes are supported.

- In Master mode;

Use the clock of BCKO and a LRO pin output clock for digital audio data transfer.

- In Slave mode;

The clock output from a master device is needed for the input terminal of BCKI and LRI.

A device in the system generates the transmitted clock become a standard. The other devices are set according to the transmitted clock. The device generating transmitted clock is called Master Device. The device according to the transmitted clock is called Slave Device. NJU26125 usually operates Slave Device. However, NJU26125 becomes Master Device in case of SLAVEb set the High level and NJU26125 is set Master mode by firmware command. In Slave mode, clock inputted to the BCK pin and the LR pin is used to digital audio signal transmission. In Master mode, clock outputted to the BCK pin and the LR pin is used to digital audio signal transmission.

### 2.1 Audio Clock

Three kinds of clocks are needed for digital audio data transfer.

- (1) LR clock (LR) is needed by serial-data transmission. It is the same as the sampling frequency of a digital audio signal.
- (2) Bit clock (BCK) is needed by serial-data transmission. It becomes the multiple of LR clock.
- (3) Master clock (MCK) is needed by A/D, D/A converter, etc. It becomes the multiple of LR clock. It is not related to serial audio data transmission.

In SLAVEb is High level, the MCK pin becomes buffer output pin for input clock to the CLK pin after NJU26125 resets. The MCK output is able to be stopped by firmware command.

In SLAVEb is Low level, MCK pin becomes system clock input pin. It is not insure to change the logical switch of SLAVEb pin during operating. If it is necessary to change SLAVEb pin setting, reset NJU26125 every time.

**Table 5 SLAVEb, BCK, LR, MCK**

SLAVEb and firmware setting	LR pin	BCK pin	MCK pin
SLAVEb="Low" Firmware: each	LR clock input DSP slave operating	Bit clock input DSP slave operating	NJU26125 operating clock input (MCK or CLK)
SLAVEb="H" Firmware: Slave			Master clock output (Buffer of CLK)
SLAVEb="H" Firmware: Master	LR clock output DSP Master operating	Bit clock output DSP Master operating	

In NJU26125 is used by 256 times of Maximum sampling frequency, NJU26125 is able to output LR clock of same sampling rate and two-third times of sampling rate, and output BCK clock of 32 times sampling rate and 64 times sampling rate in Master mode.

**Table 6 Input clock (In Slave mode)**

Mode	Clock Signal	Multiple Frequency	32kHz	44.1kHz	48kHz
DSP Slave	LR	1fs	32kHz	44.1kHz	48kHz
	BCK (32fs)	32fs	1.024MHz	1.4112MHz	1.536MHz
	BCK (64fs)	64fs	2.048MHz	2.822MHz	3.072MHz
	MCK (SLAVEb="L")	Input terminal: Clock is generated by MCK or CLK			
	MCK (SLAVEb="H")	Buffer output of CLK	12.288MHz		

**Table 7 Output clock (In Master mode)**

Mode	Clock Signal	Multiple Frequency	CLK pin frequency		
			32kHz	44.1kHz	48kHz
DSP Master	LR	1fs	32kHz	-	48kHz
	BCK (32fs)	32fs	1.024MHz	-	1.536MHz
	BCK (64fs)	64fs	2.048MHz	-	3.072MHz
	MCK	Buffer output of CLK	12.288MHz		

### 3. Digital Audio Interface

#### 3.1 Digital Audio Data Format

The NJU26125 can use three kinds of formats hereafter as industry-standard digital audio data format.

- (1) I<sup>2</sup>S : MSB is put on the 2nd bit of LR clock change rate.(1 bit is delayed to left stuffing)
- (2) Left-justified : LR clock – MSB is placed for changing.
- (3) Right-justified : LSB is placed just before LR clock change rate.

The main differences among three kinds of formats are in the position relation between LR clock (LR) and an audio data (SDI, SDO).

- In every format: : a left channel is transmitted previously.
- In Right/Left-justified : LR clock ='High' shows a left channel.
- I<sup>2</sup>S : LR clock="Low" shows a left channel.
- The Bit clock BCK is used as a shift clock of transmission data. The number of clocks more than the number of sum total transmission bits of a L/R channel is needed at least.
- One cycle of LR clock is one sample of a stereo audio data. The frequency of LR clock becomes equal to a sample rate (Fs).
- The NJU26125 supports serial data format which includes 32(32fs) or 64(64fs) BCK clocks. This serial data format is applied to both MASTER and SLAVE mode.

#### 3.2 Serial Audio Data Input/output

The NJU26125 audio interface includes 3 data input lines: SDI0, SDI1 and SDI2 (Table 8). 3 data output lines: SDO0, SDO1 and SDO2. (Table 9).

**Table 8 Serial Audio Input Pin Description**

Pin No.	Symbol	Description
6	SDI0	Audio Data Input 0 L/R
5	SDI1	Audio Data Input 1 L/R
4	SDI2	Audio Data Input 2 Navigation Voice

**Table 9 Serial Audio Output Pin Description**

Pin No.	Symbol	Description
19	SDO0	Audio Data Output 0 Front L/R
20	SDO1	Audio Data Output 1 Rear L/R
21	SDO2	Audio Data Output 2 Subwoofer L/R

Please refer "Fig.2 NJU26125 Function Diagram".

The NJU26125 can use three kinds of formats hereafter as industry-standard digital audio data format; (1) I<sup>2</sup>S (2) Left-Justified (3) Right-justified and 16 / 18 / 20 / 24bits data length. (Fig.6-1 to Fig6-12)  
 An audio interface input and output data format become the same data format.

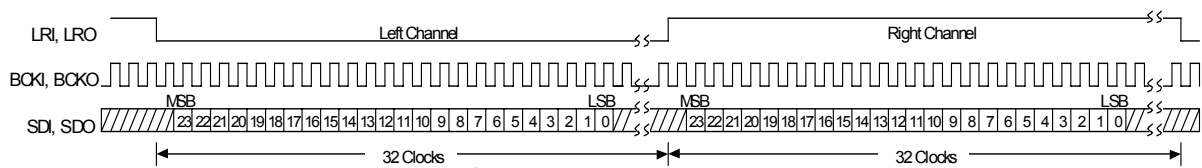

**Fig.6-1 I<sup>2</sup>S Data Format 64fs, 24bit Data**

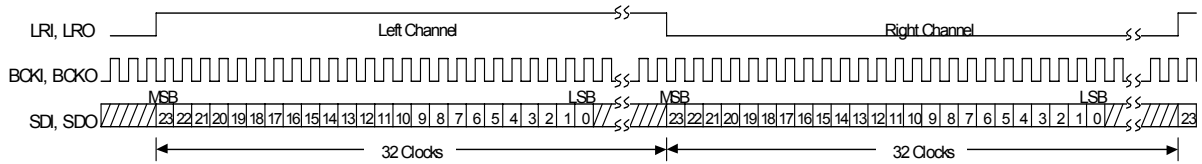

**Fig.6-2 Left-Justified Data Format 64fs, 24bit Data**

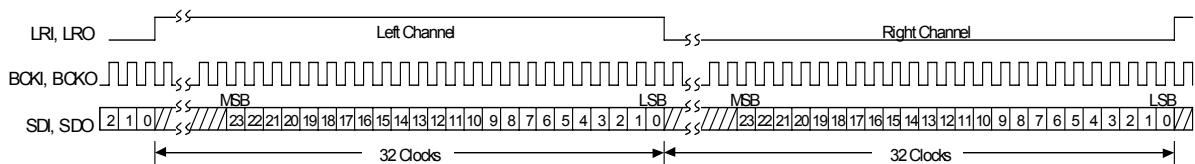

**Fig.6-3 Right-Justified Data Format 64fs, 24bit Data**

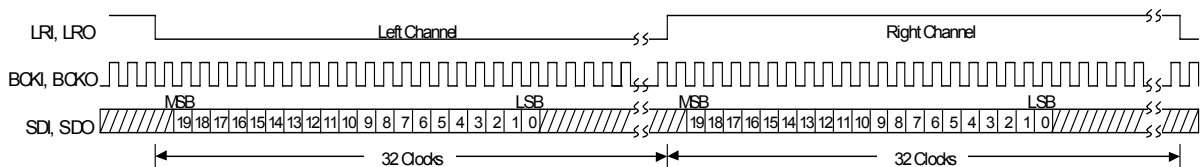

**Fig.6-4 I<sup>2</sup>S Data Format 64fs, 20bit Data**

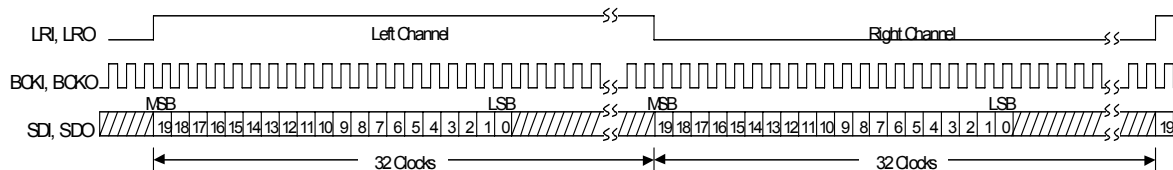

**Fig.6-5 Left-Justified Data Format 64fs, 20bit Data**

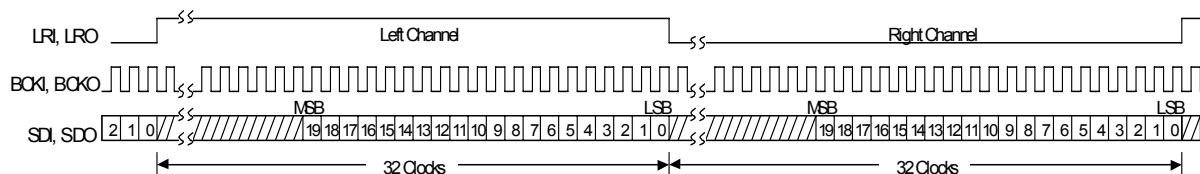

**Fig.6-6 Right-Justified Data Format 64fs, 20bit Data**

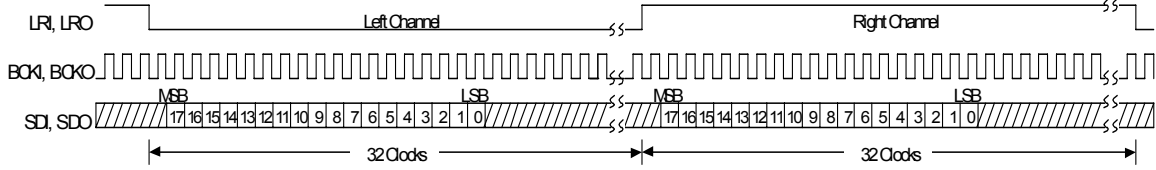

Fig.6-7 I²S Data Format 64fs, 18bit Data

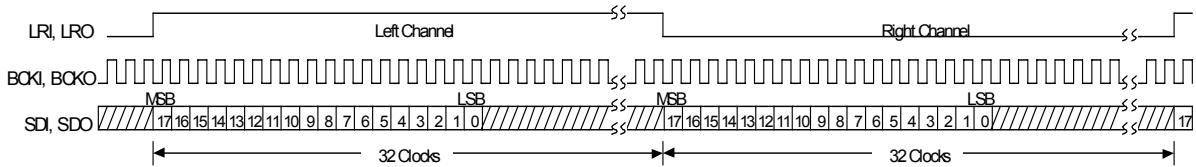

Fig.6-8 Left-Justified Data Format 64fs, 18bit Data

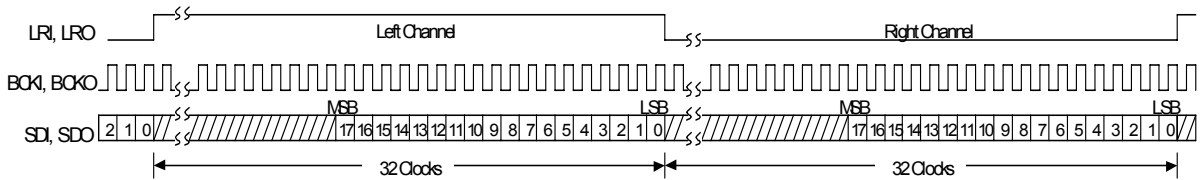

Fig.6-9 Right-Justified Data Format 64fs, 18bit Data

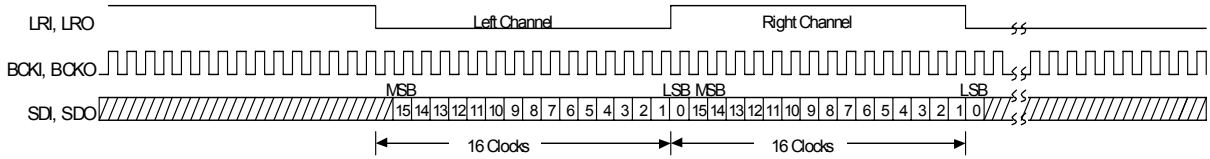

Fig.6-10 I²S Data Format 32fs, 16bit Data

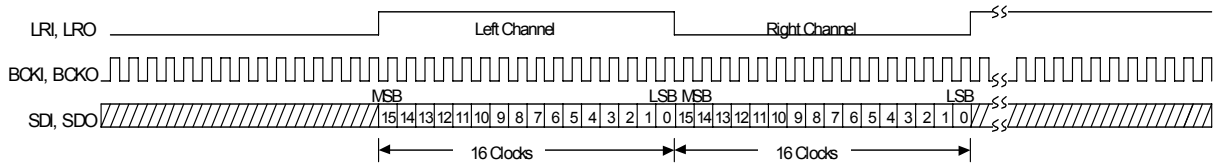

Fig.6-11 Left-Justified Data Format 32fs, 16bit Data

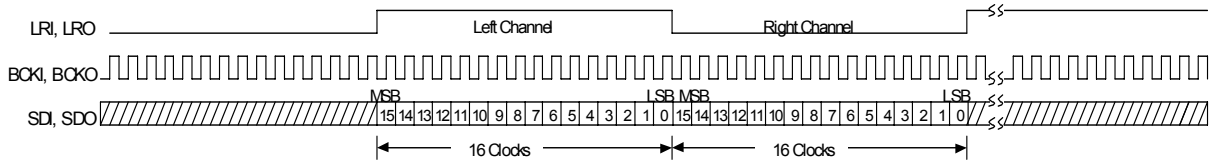

Fig.6-12 Right-Justified Data Format 32fs, 16bit Data

## 3.3 Serial Audio Input Timing

**Table 10 Serial Audio Input Timing Parameters** (  $V_{DD}=3.3V, T_a=25^{\circ}C$  )

Parameter	Symbol	Test Condition	Min	Typ.	Max	Units
BCK Frequency *	$f_{BCKI}$		-	-	6.5	MHz
BCK Period *						
Low Pulse Width	$t_{SIL}$		75	-	-	ns
High Pulse Width	$t_{SIH}$		75	-	-	ns
BCK to LR Time **	$t_{SLI}$		40	-	-	ns
LR to BCK Time **	$t_{LSI}$		40	-	-	ns
Data Setup Time	$t_{DS}$		15	-	-	ns
Data Hold Time	$t_{DH}$		15	-	-	ns

\* It is the regulation of absolute maximum ratings. Maximum frequency of BCK is limited.

\*\* It is the regulation in slave mode.

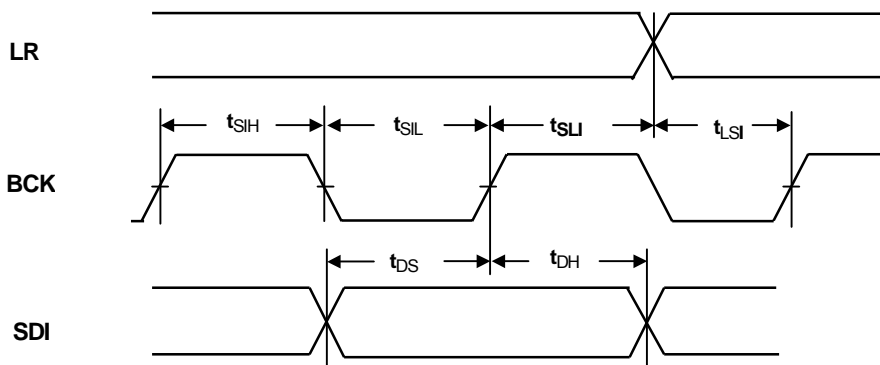
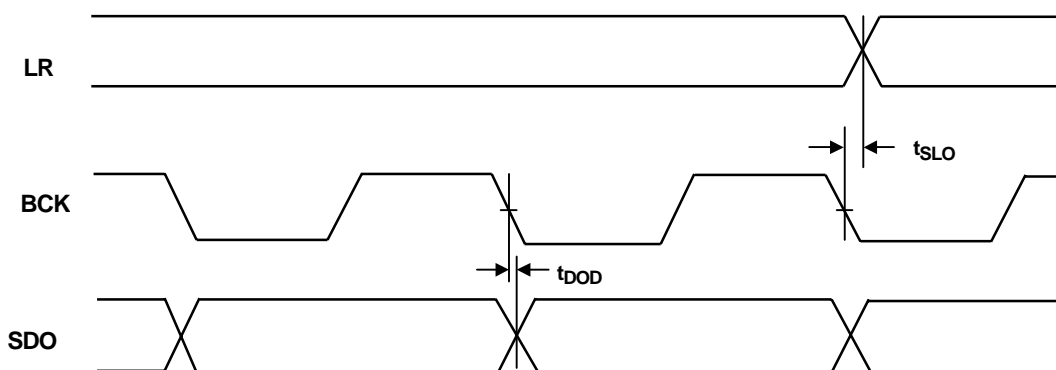

**Fig.7 Serial Audio Input Timing**

**Table 11 Serial Audio Output Timing Parameters** (  $V_{DD}=3.3V, T_a=25^{\circ}C$  )

Parameter	Symbol	Test Condition	Min	Typ.	Max	Units
BCK to LR Time *	$t_{SLO}$	$C_L=25pF$	-15	-	15	ns
Data Output Delay	$t_{DOD}$		-	-	15	ns

\* It is the regulation in Master mode.



**Fig.8 Serial Audio Input Timing**

■ Host Interface

The NJU26125 can be controlled via Serial Host Interface (SHI) using I<sup>2</sup>C bus. Data transfers are in 8 bit packets (1 byte) when using either format. Refer to serial Host Interface Pin Description.(Table 12)

**Table 12 Serial Host Interface Pin Description**

Pin No.	Symbol (I <sup>2</sup> C bus)	I <sup>2</sup> C bus Format
16	AD1	I <sup>2</sup> C bus address Bit
22	SDA	Serial Data Input/Output (Open Drain Input/Output)
23	SCL	Serial Clock

**Note :** SDA pin (No.22) is a bi-directional open drain terminal. This pin requires a pull-up resistor.

AD1 (No.16) pin is input pin with pull-down. AD1 (No.16) pin is connected with V<sub>DD</sub> or V<sub>SS</sub> through 3.3kΩ resistance.

When NJU26125 is stopped by power supply VDD, SDA pin and SCL pin become Hi-Z. But these pins are not 5V tolerant when VDD stops.

■ I<sup>2</sup>C bus

I<sup>2</sup>C bus interface transfers data to the SDA pin and clocks data to the SCL pin. SDA pin is a bi-directional open drain and requires a pull-up resistor.

AD1 pin is used to configure the seven-bit SLAVE address of the serial host interface. (Table 13) This offers additional flexibility to a system design by two different SLAVE addresses of the NJU26125. An address can be arbitrarily set up by the AD1 pin. The I<sup>2</sup>C address of AD1 is decided by connection of AD1 pin.

**Table 13 I<sup>2</sup>C bus SLAVE Address**

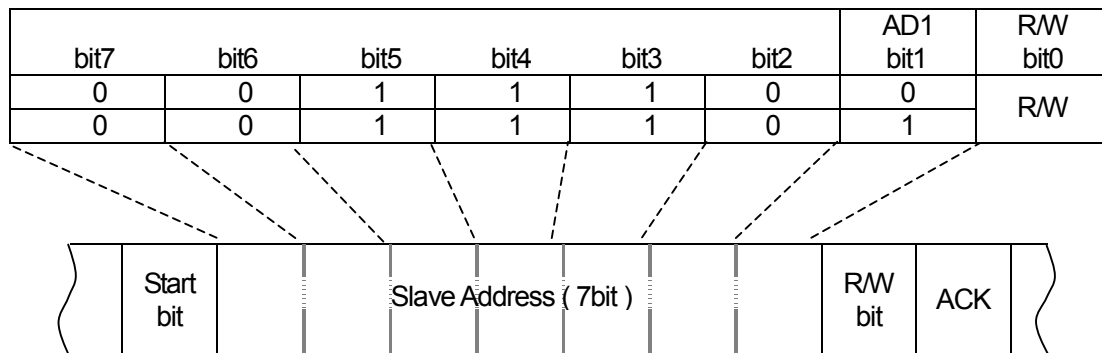

\* SLAVE address is 0 when AD1 is “Low”. SLAVE address is 1 when AD1 is “High”.

\* SLAVE address is 0 when RW is “W”. SLAVE address is 1 when RW is “R”.

**Table 14 I<sup>2</sup>C bus Interface Timing Parameters** (V<sub>DD</sub>=3.3V, f<sub>OSC</sub>=12.288MHz, Ta=25°C)

Parameter	Symbol	Min	Max	Units
SCL Clock Frequency	f <sub>SCL</sub>	0	400	kHz
Start Condition Hold Time	t <sub>HD:STA</sub>	0.6	-	μs
SCL "Low" Duration	t <sub>LOW</sub>	1.3	-	μs
SCL "High" Duration	t <sub>HIGH</sub>	0.6	-	μs
Start Condition Setup Time	t <sub>SU:STA</sub>	0.6	-	μs
Data Hole Time <sup>*1</sup>	t <sub>HD:DAT</sub>	0	0.9	μs
Data Setup Time	t <sub>SU:DAT</sub>	250	-	ns
Rising Time	t <sub>R</sub>	-	1000	ns
Falling Time	t <sub>F</sub>	-	300	ns
Stop Condition Setup Time	t <sub>SU:STO</sub>	0.6	-	μs
Bus Release Time <sup>*2</sup>	t <sub>BUF</sub>	1.3	-	μs

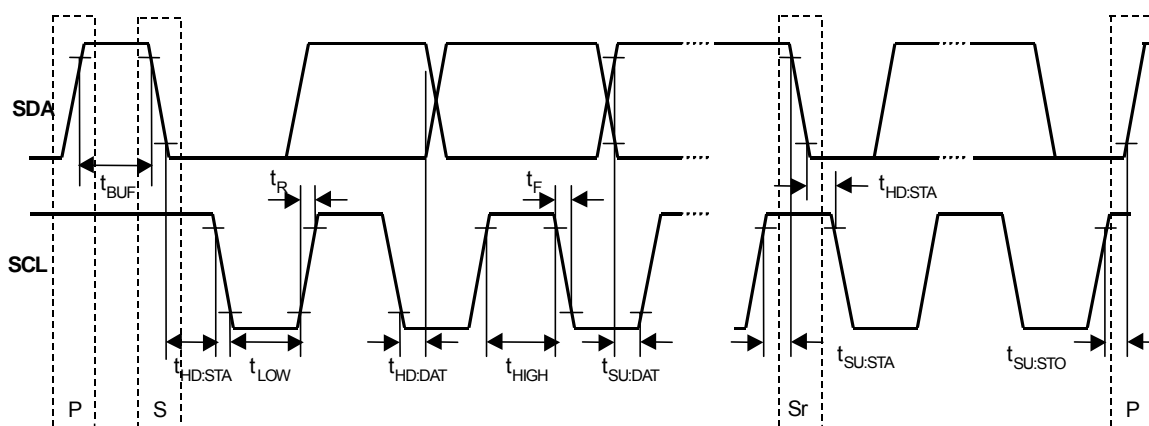

**Fig.9 I<sup>2</sup>C bus Timing**

**Note :**

- \*1 t<sub>HD:DAT</sub>: Keep data 100ns hold time to avoid indefinite state by SCL falling edge.
- \*2 This item shows the interface specification. The interval of a continuous command is specified separately.



## ■ Pin setting

The NJU26125 operates default command setting after resetting the NJU26125. In addition, the NJU26125 restricts operation at power on by setting PROC pin (No.17) (Table 15). This pin is input pin. However, this pin operates as bi-directional pin. Connect with  $V_{DD}$  or  $V_{SS}$  through 3.3k $\Omega$  resistance.

**Table 15 Pin setting**

Pin No.	Symbol	Setting	Function
17	PROC	“High”	The NJU26125 does not operate after reset. Sending start command is required for starting operation.
		“Low”	The NJU26125 operates default setting after reset. The default value of Master Volume is Mute.

## ■ WatchDog Clock

The NJU26125 outputs clock pulse through WDC (No.18) pin during normal operation.

The NJU26125 generates a clock pulse through the WDC terminal after resetting the NJU26125. The WDC clock is useful to check the status of the NJU26125 operation. For example, a microcomputer monitors the WDC clock and checks the status of the NJU26125. When the WDC clock pulse is lost or not normal clock cycle, the NJU26125 does not operate correctly. Then reset the NJU26125 and set up the NJU26125 again.

Watchdog clock output cycle is about 100msec.

**Note:** If input and output of an audio signal stop and an audio interface stops, WDC can't output.

That is because it has controlled based on the signal of an audio interface.

## ■ NJU26125 Command Table

**Table 16 NJU26125 Command**

No.	Command
1	Set Task
2	System State
3	Sample Rate Select
4	Smooth Control Config
5	Master Volume Control
6	Channel Trim Control
7	Input Trim
8	Surround Gain
9	Surround Channel Gain
10	Surround Mix Ratio
11	Phase Shifter Fc
12	Phase Shifter Mode
13	Time Alignment
14	Filter Fc
15	Filter Switch

No.	Command
16	Elevation Gain
17	Bass Enhance LPF Fc
18	Bass Enhance Gain
19	Bass Enhance Release Time Select
20	PEQ F0
21	PEQ Q
22	PEQ Gain
23	PEQ Mode Config
24	PEQ Smooth Config
25	Navigation Voice Mix Trim
26	Firmware Revision Number Request
27	DSP Reset Command
28	Boot with Mute
29	Boot with Unmute
30	No Operation (Nop)

■ Package

SSOP24-C2, Pb-Free

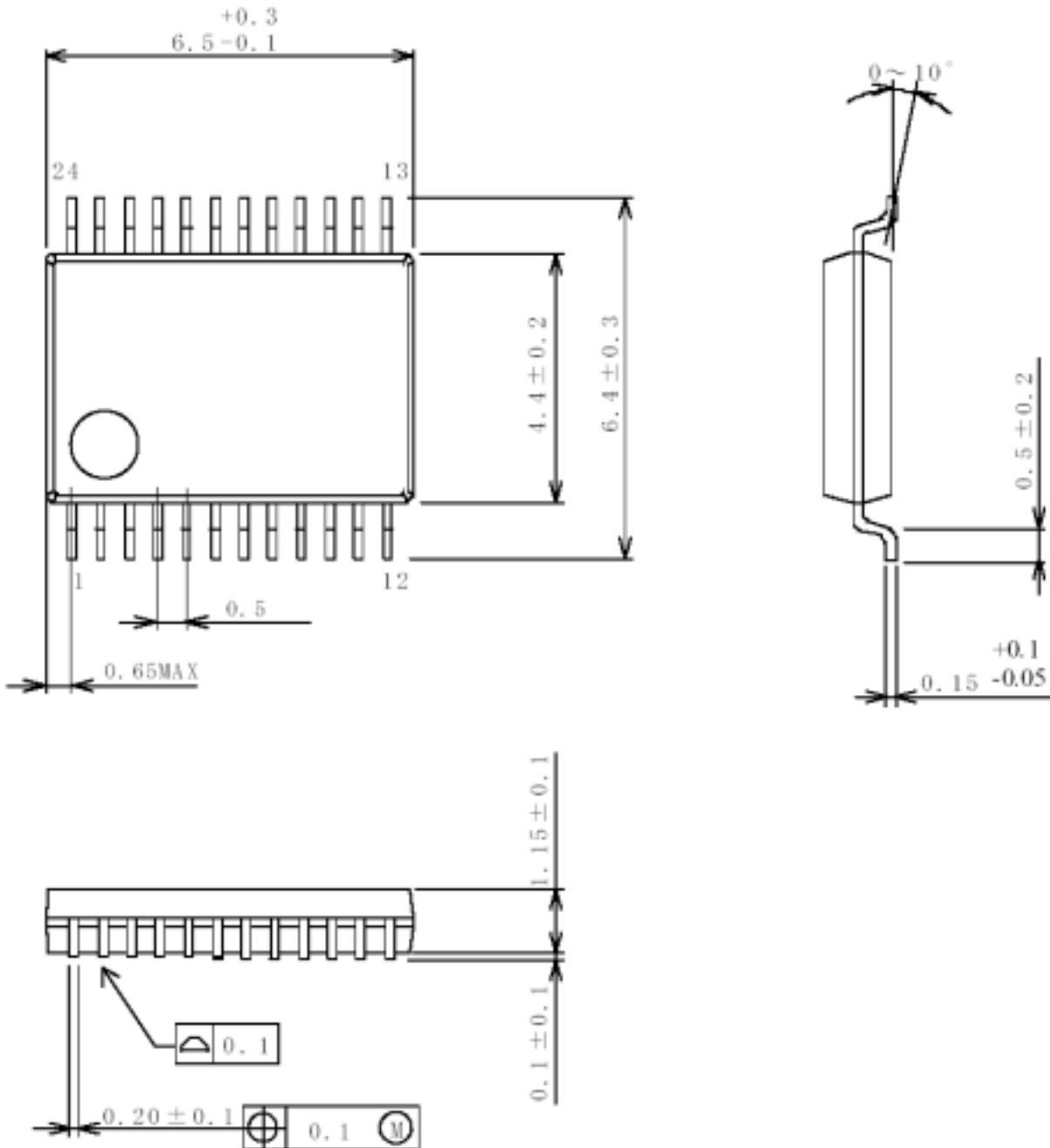

[CAUTION]  
 The specifications on this databook are only given for information, without any guarantee as regards either mistakes or omissions. The application circuits in this databook are described only to show representative usages of the product and not intended for the guarantee or permission of any right including the industrial rights.