

## SINGLE-SUPPLY DUAL OPERATIONAL AMPLIFIER

### ■ GENERAL DESCRIPTION

The NJM2904C / NJM2904CA consists of two independent, high gain, internally frequency compensated operation amplifiers, which were designed specifically to operate from a single power supply over a wide range of voltages. Operation from split power supplies is also possible and the low power supply current drain is independent of the magnitude of the power supply voltage.

Application areas include transducer amplifiers, DC gain blocks, and all the conventional op amp circuits, which now can be more easily implemented in single power supply systems. For example, the NJM2904C can be directly operated off of the standard +5V power supply voltage, which is used in digital systems and will easily provide the required interface electronics without requiring the additional  $\pm 15V$  power supplies.

### ■ FEATURES

- Single Supply
- Operating Voltage +3V to +32V
- Low Operating Current 0.7mA typ.
- Slew Rate 0.6V/ $\mu$ s typ.
- Bipolar Technology
- Package Outline SOP8, DMP8, SSOP8, EQFN12-E2,  
MSOP8 (TVSP8) \*\*MEET JEDEC MO-187-DA / THIN TYPE
- Internal ESD protection Human body model (HBM)  $\pm 2000V$  typ.
- Wide temperature range -40°C to +125°C
- Input Offset Voltage Grade

NJM2904C(Normal-Grade)	NJM2904CA(A-Grade)
7mV max.	2mV max.

\* NJM2904CME2 don't have a A version.

### ■ PACKAGE OUTLINE



### ■ PIN CONFIGURATION

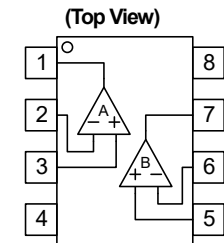

- PIN FUNCTION**
1. A OUTPUT
  2. A -INPUT
  3. A +INPUT
  4. V
  5. B + INPUT
  6. B - INPUT
  7. B OUTPUT
  8. V<sup>+</sup>

NJM2904CG/2904CAG  
NJM2904CM/2904CAM  
NJM2904CRB1/2904CARB1  
NJM2904CV/2904CAV

(Top View)

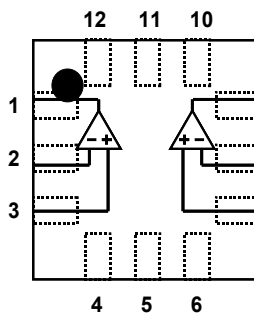

NJM2904CME2 (Note1, 2, 3)

(Bottom View)

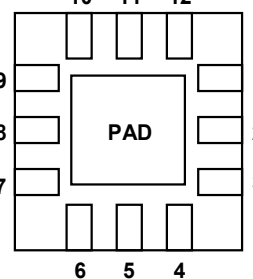

- PIN FUNCTION**
1. A OUTPUT
  2. A -INPUT
  3. A +INPUT
  4. NC
  5. V
  6. NC
  7. B +INPUT
  8. B -INPUT
  9. B OUTPUT
  10. NC
  11. V<sup>+</sup>
  12. NC

(Note1) The PAD have to be wired as short as possible to connect with a V<sup>+</sup> terminal.

(Note2) The PAD is electronically connected to the backside of the die. But, there cannot be used as V<sup>-</sup> pin.

(Note3) The NC pin is not internally connected.

### ■ EQUIVALENT CIRCUIT ( 1/2 Shown )

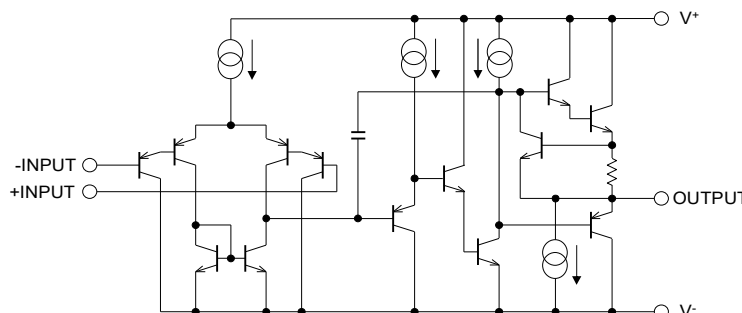

# NJM2904C / NJM2904CA

## ■ ABSOLUTE MAXIMUM RATINGS

( Ta=25°C )

PARAMETER	SYMBOL	RATINGS	UNIT
Supply Voltage	$V^+ - V^-$	+32	V
Differential Input Voltage (Note4)	$V_{ID}$	±32	V
Input Voltage (Note5)	$V_{IN}$	$V^- - 0.3$ to $V^+ + 32$	V
Output Terminal Input Voltage	$V_o$	$V^- - 0.3$ to $V^+ + 0.3$	V
Power Dissipation	$P_D$	SOP : 690 (Note6) 1000(Note7) DMP : 470 (Note6) 600 (Note7) MSOP : 510 (Note6) 680 (Note7) SSOP : 430 (Note6) 540(Note7) EQFN : 440 (Note8) 680(Note9)	mW
Operating Temperature Range	$T_{opr}$	-40 to +125	°C
Storage Temperature Range	$T_{stg}$	-65 to +150	°C

(Note4) Differential voltage is the voltage difference between +INPUT and -INPUT.

(Note5) Input voltage is the voltage should be allowed to apply to the input terminal independent of the magnitude of  $V^+$ .

The normal operation will establish when any input is within the Common Mode Input Voltage Range of electrical characteristics.

(Note6) EIA/JEDEC STANDARD Test board (76.2 x 114.3 x 1.6mm, 2layers, FR-4) mounting

(Note7) EIA/JEDEC STANDARD Test board (76.2 x 114.3 x 1.6mm, 4layers, FR-4) mounting

(Note8) EIA/JEDEC STANDARD Test board (101.5 x 114.3 x 1.6mm, 2layers, FR-4) mounting

(Note9) EIA/JEDEC STANDARD Test board (101.5 x 114.3 x 1.6mm, 4layers, FR-4) mounting

## ■ ELECTRICAL CHARACTERISTICS

( $V^+=5V$ ,  $V^-=0V$ ,  $T_a=25^\circ C$ , unless otherwise noted.)

PARAMETER	SYMBOL	TEST CONDITION	MIN.	TYP.	MAX.	UNIT
Supply Current (All amplifiers)	$I_{SUPPLY}$	$V^+=5V$ , no signal $V^+=30V$ , no signal	-	0.7	1.2	mA
Input Offset Voltage	$V_{IO}$	$R_S=0\Omega$ $R_S=0\Omega$ , NJM2904CA	-	0.5	7	mV
Input Bias Current	$I_B$		-	20	150	nA
Input Offset Current	$I_{IO}$		-	2	30	nA
Open-Loop Voltage Gain	$A_V$	$R_L \geq 2k\Omega$	94	100	-	dB
Supply Voltage Rejection Ratio	SVR	$V^+=5$ to $30V$ , $R_S < 10k\Omega$	65	100	-	dB
Common Mode Input Voltage Range	$V_{ICM}$	$V^+=30V$ , $CMR > 70dB$	0	-	$V^+ - 1.5$	V
Common Mode Rejection Ratio	CMR	$R_S < 10k\Omega$	70	100	-	dB
Output Source Current	$I_{SOURCE}$	$V^+=15V$ , $V_o = +2V$ , $V_{IN+} = 1V$ , $V_{IN-} = 0V$	20	40	-	mA
Output Sink Current	$I_{SINK}$	$V^+=15V$ , $V_o = +2V$ , $V_{IN+} = 0V$ , $V_{IN-} = 1V$ $V^+=15V$ , $V_o = +0.2V$ , $V_{IN+} = 0V$ , $V_{IN-} = 1V$	10 12	20 50	-	mA $\mu A$
High-level output voltage	$V_{OH}$	$R_L = 2k\Omega$ , $V^+ = 30V$ $R_L = 10k\Omega$ , $V^+ = 30V$	26 27	27 28	-	V
Low-level output voltage	$V_{OL}$	$R_L = 10k\Omega$	-	5	20	mV
Slew Rate	SR	$V^+ = 15V$ , $V_{IN} = 0.5$ to $3V$ , $C_L = 100pF$	-	0.6	-	V/ $\mu s$
Gain Band Width Product	GBW	$V^+ = 30V$ , $f = 100kHz$ , $V_{IN} = 10mV_{rms}$ , $R_L = 2k\Omega$ , $C_L = 100pF$	-	1.1	-	MHz
Total Harmonic Distortion + Noise	THD+N	$f = 1kHz$ , $G_v = 20dB$ , $R_L = 2k\Omega$ , $V_o = 2V_{pp}$ , $C_L = 100pF$	-	0.02	-	%
Equivalent input noise voltage	$e_n$	$f = 1kHz$ , $R_S = 100\Omega$ , $V^+ = 30V$	-	30	-	nV/ $\sqrt{Hz}$
Channel Separation	CS	$1kHz < f < 10kHz$	-	120	-	dB

## TYPICAL CHARACTERISTICS

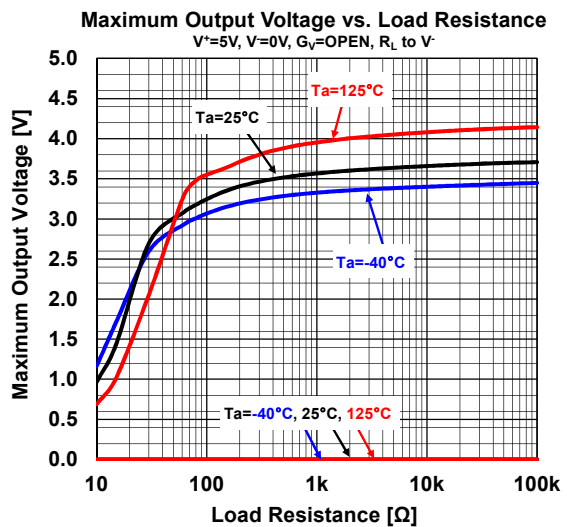
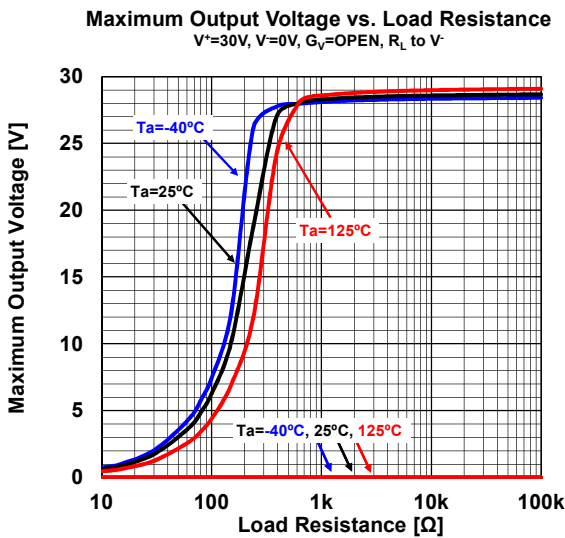
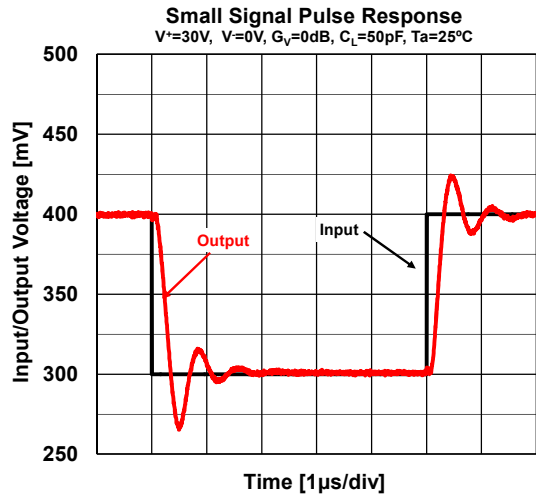
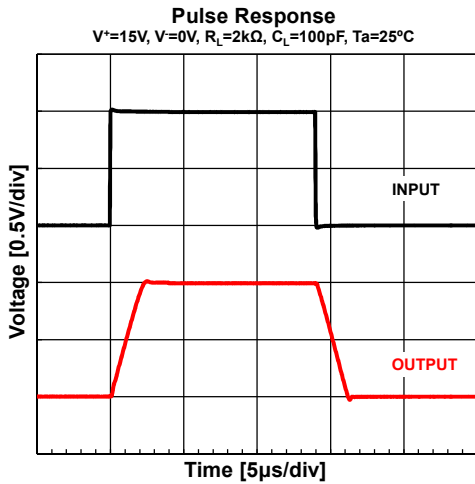
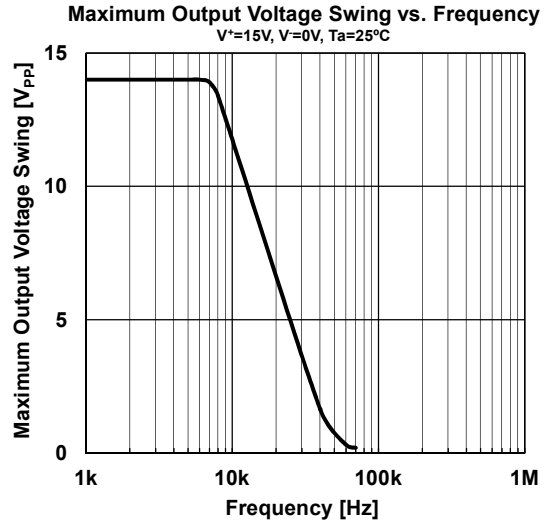
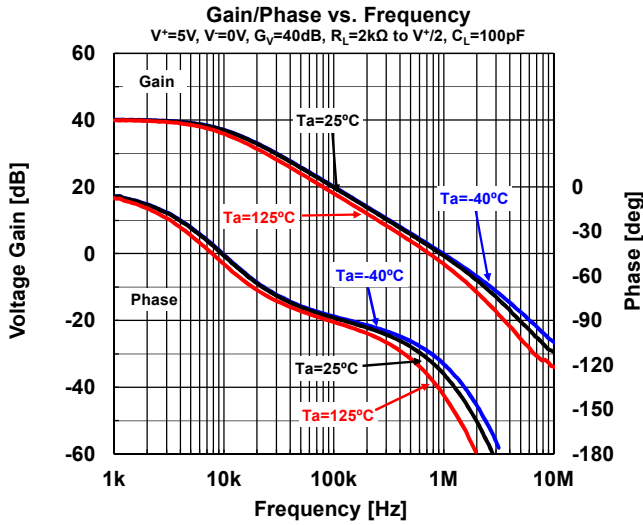

# NJM2904C / NJM2904CA

## ■ TYPICAL CHARACTERISTICS

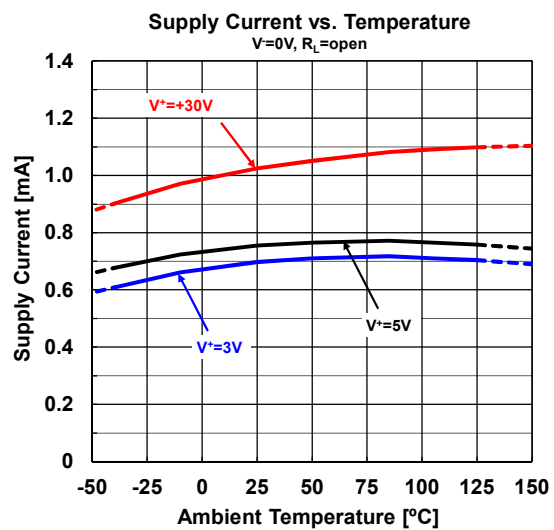
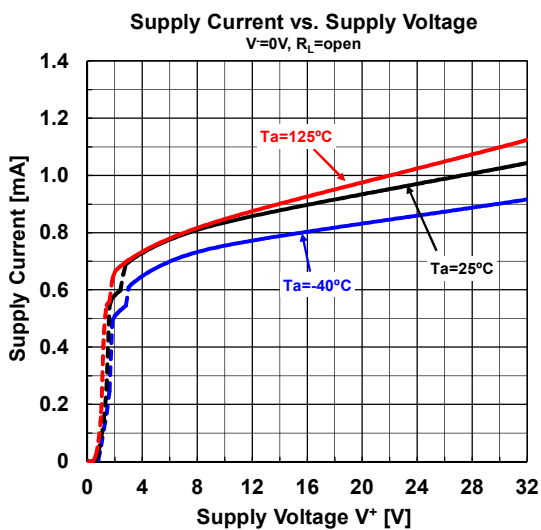
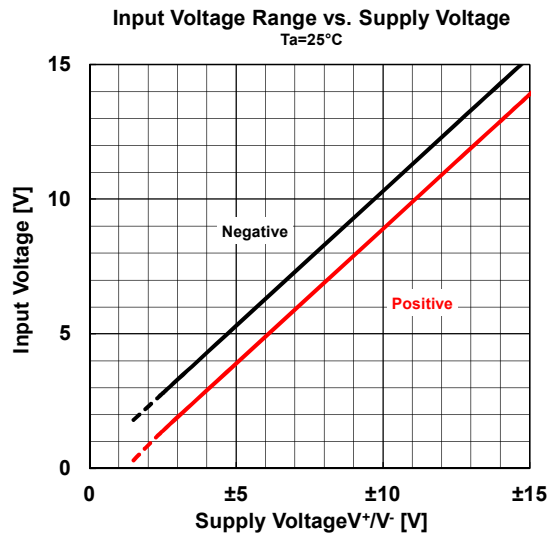
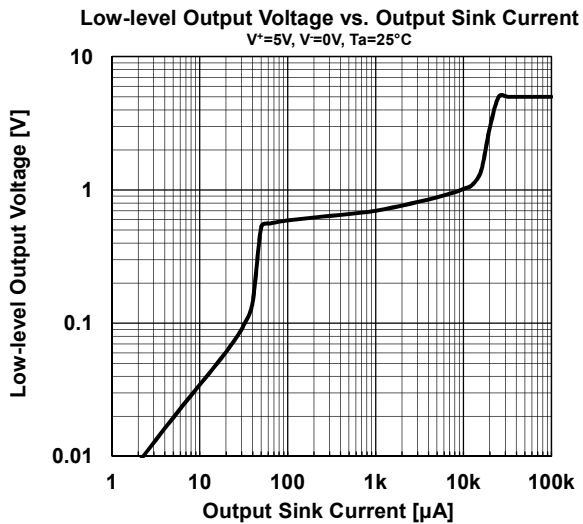
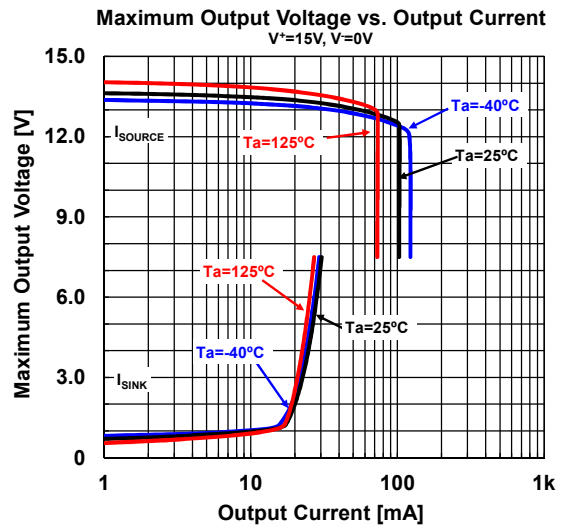
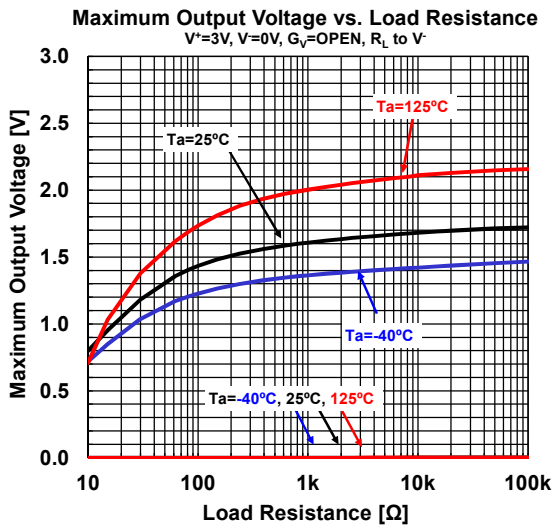

## ■ TYPICAL CHARACTERISTICS

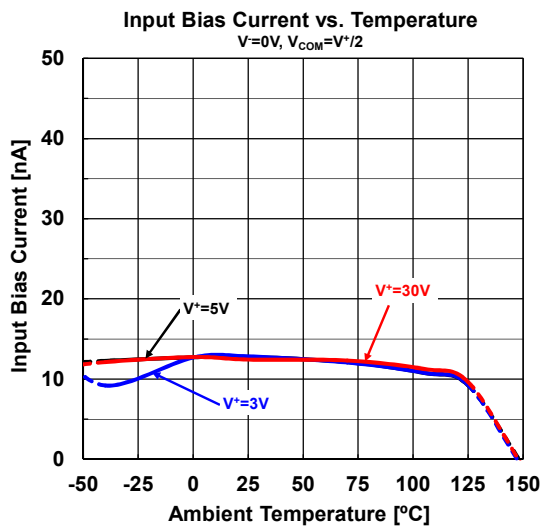
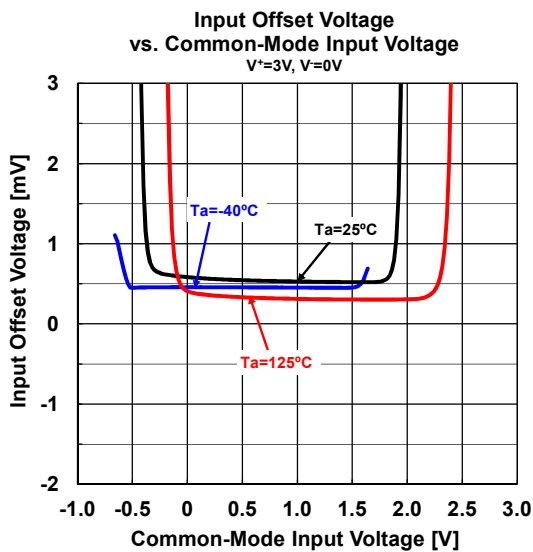
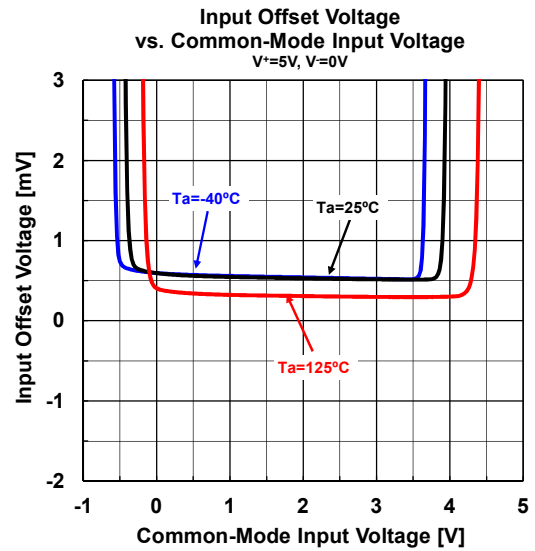
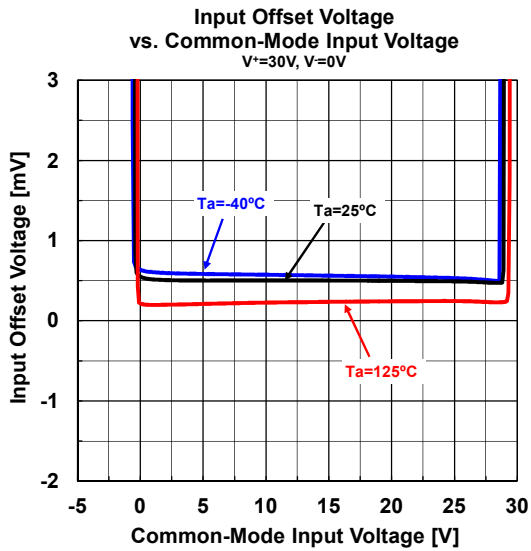
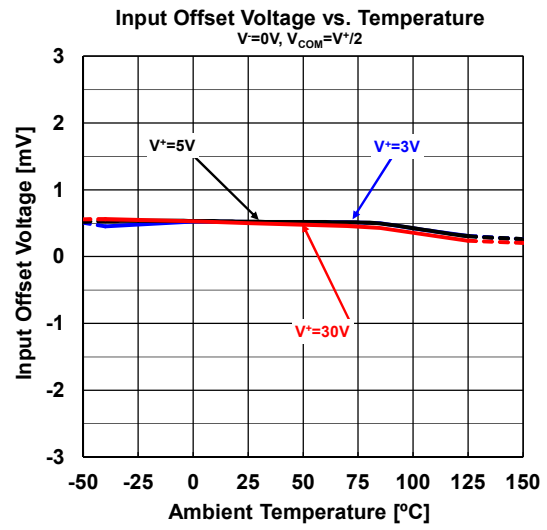
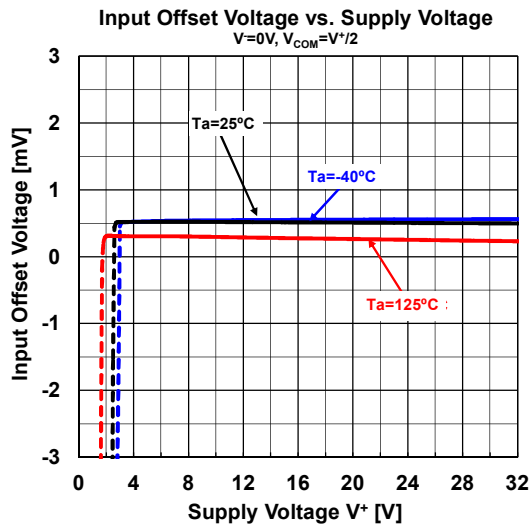

# NJM2904C / NJM2904CA

## ■ TYPICAL CHARACTERISTICS

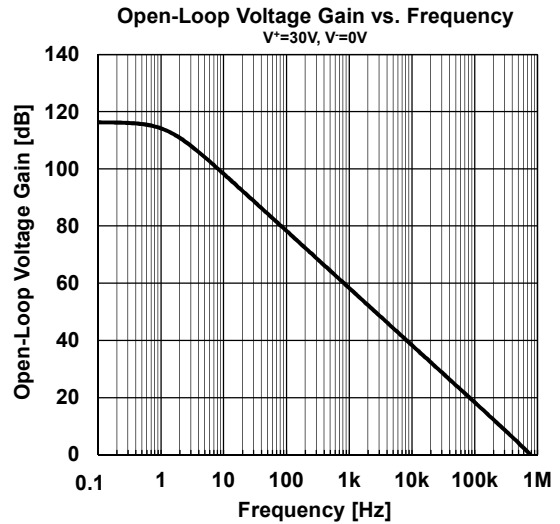
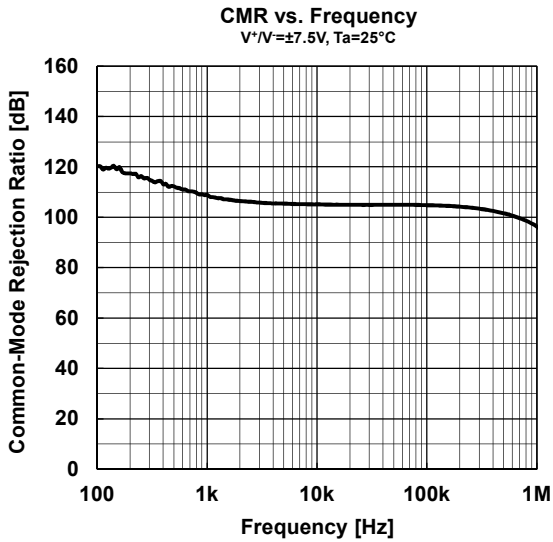
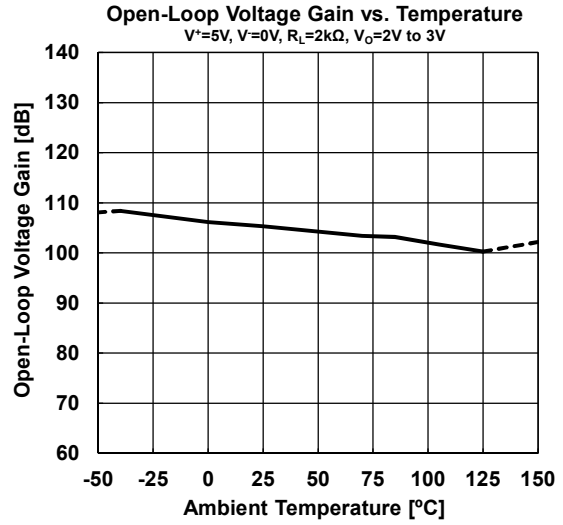
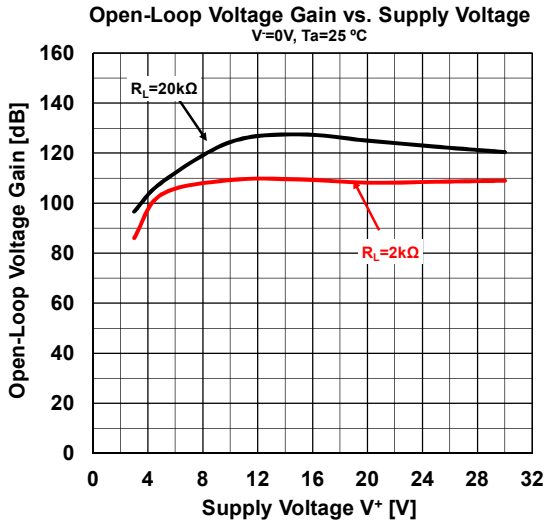

## ■ APPLICATION

Improvement of Cross-over Distortion  
Equivalent circuit at the output stage

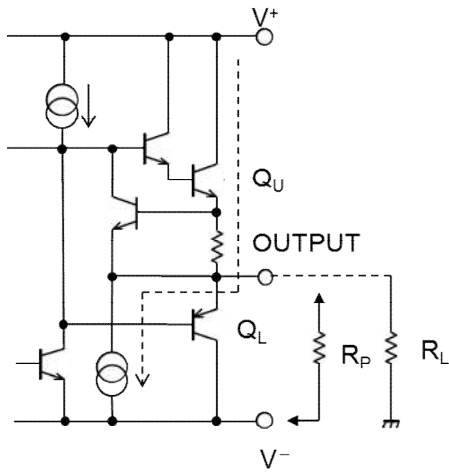

NJM2904C / NJM2904CA, in its static state ( No in and output condition ) when design,  $Q_U$  being biased by constant current ( break down beam ) yet,  $Q_L$  stays OFF.

While using with both power source mode, the cross-over distortion might occur instantly when  $Q_L$  ON.

There might be cases when application for amplifier of audio signals, not only distortion but also the apparent frequency bandwidth being narrowed remarkably.

It is adjustable especially when using both power source mode, constantly to use with higher current on  $Q_U$  than the load current ( including feedback current ), and then connect the pull-down resistor  $R_P$  at the part between output and  $V^-$  pins.

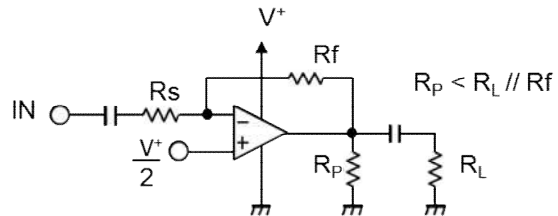
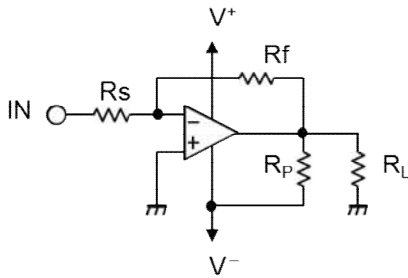

# NJM2904C / NJM2904CA

■PACKAGE OUTLINE UNIT : mm

SOP8

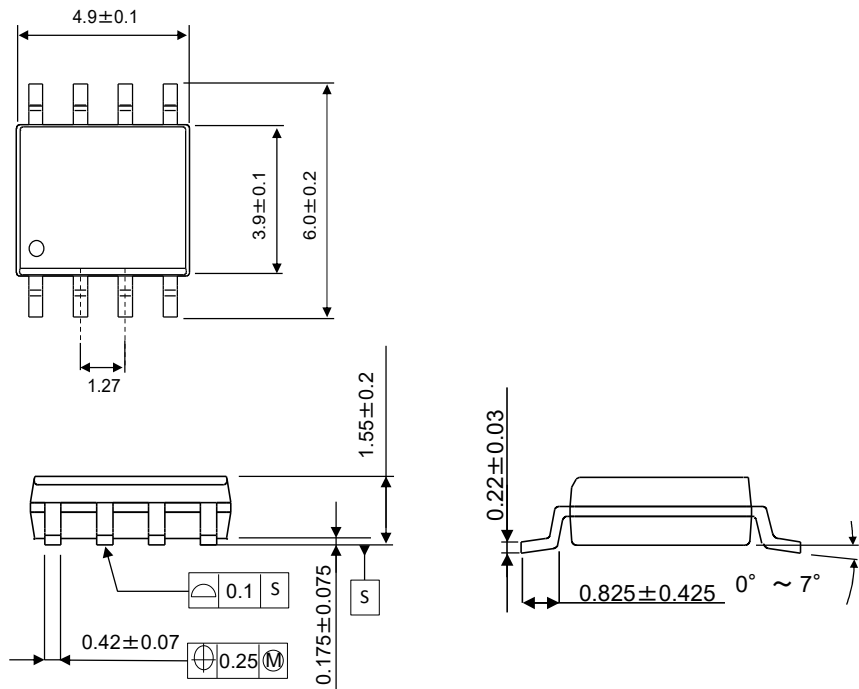

DMP8

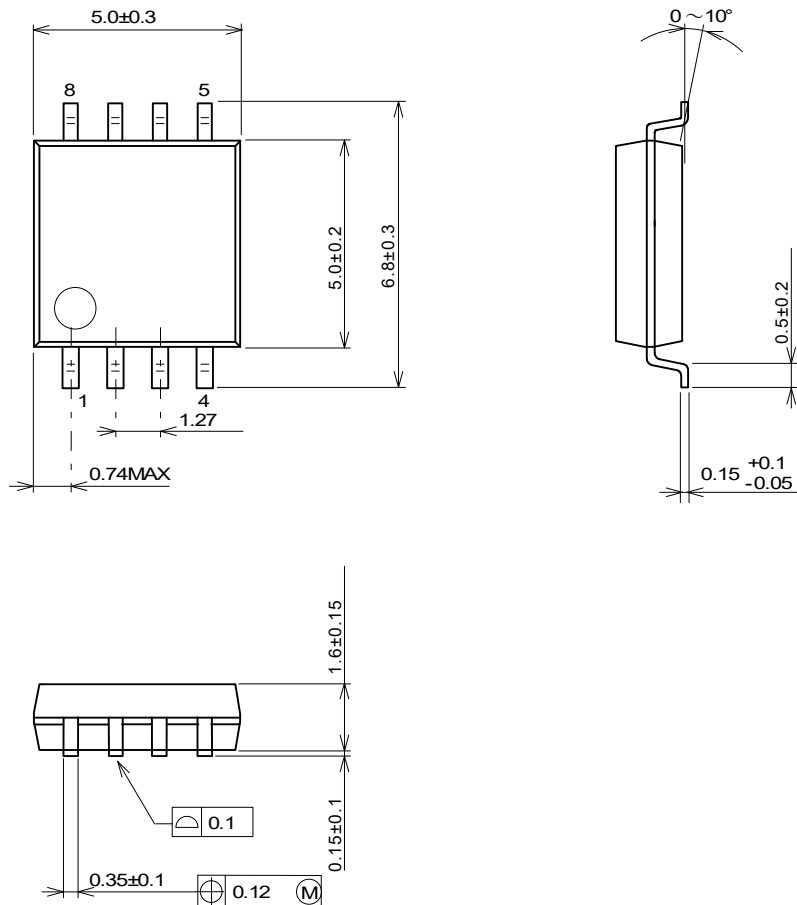



# NJM2904C / NJM2904CA

## ■PACKAGE OUTLINE UNIT : mm

MSOP8 (TVSP8)\*

\*MEET JEDEC MO-187-DA / THIN TYPE

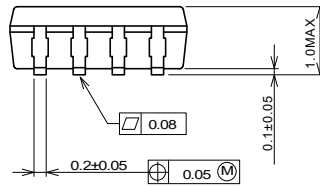
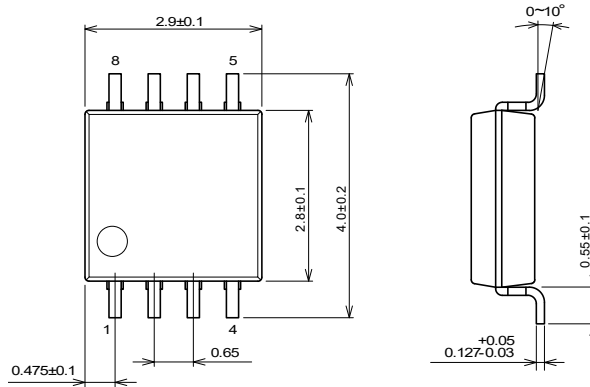

## SSOP8

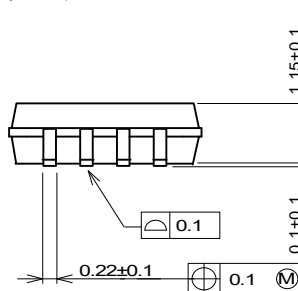
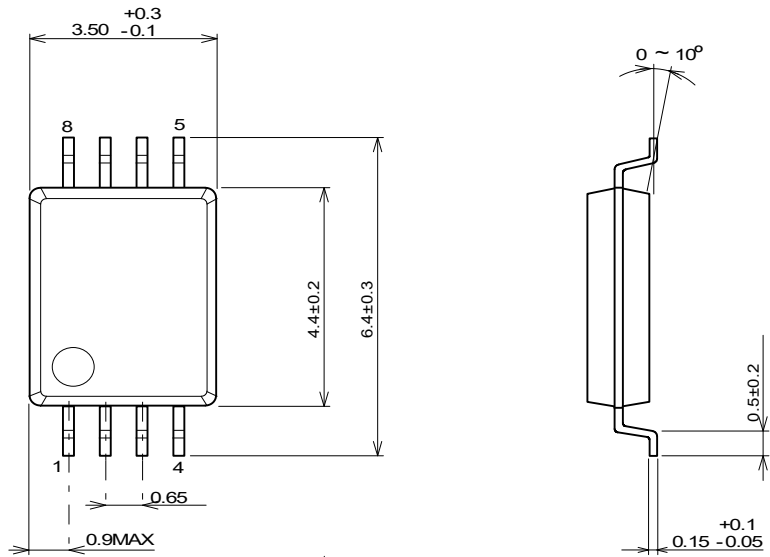

# NJM2904C / NJM2904CA

■PACKAGE OUTLINE UNIT : mm  
EQFN12-E2

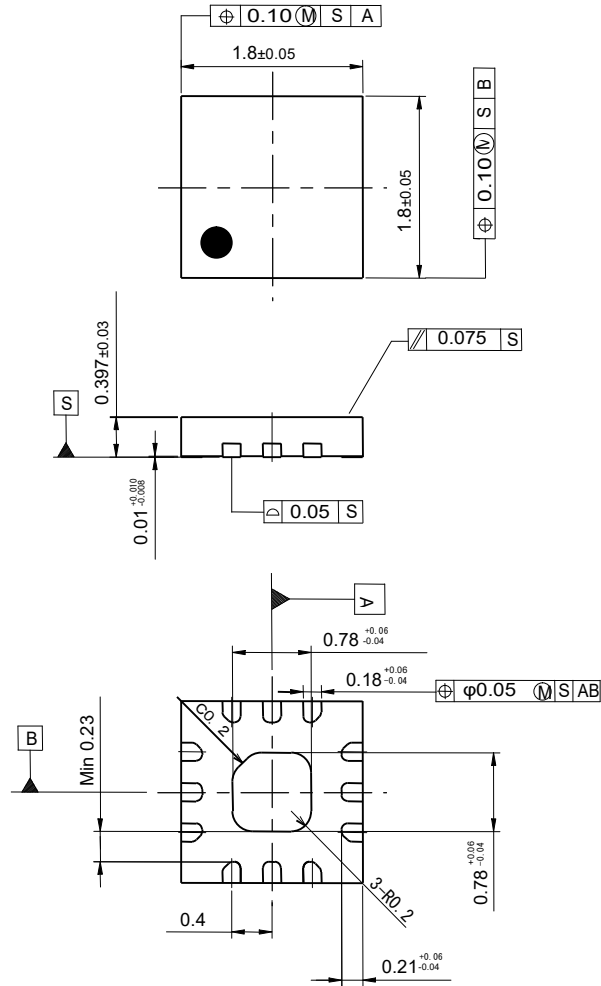

[CAUTION]  
The specifications on this databook are only given for information, without any guarantee as regards either mistakes or omissions. The application circuits in this databook are described only to show representative usages of the product and not intended for the guarantee or permission of any right including the industrial rights.