

LOW DROPOUT VOLTAGE REGULATOR

■ GENERAL DESCRIPTION

The NJM2857 is a low dropout voltage regulator. This product has Reverse Current Protection without external SBD. Advanced Bipolar technology achieves low noise, high ripple rejection and high supply voltage. 1.5A output current capacity, 4.7 μ F small decoupling capacitor, built-in noise bypass capacitor make the NJM2857 suitable for various applications.

■ PACKAGE OUTLINE

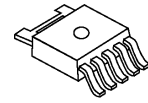

NJM2857DL3

■ FEATURES

- High Ripple Rejection 80dB typ. (f=1kHz, Vo=3V Version)
- Output Noise Voltage Vno=55 μ Vrms typ. (Vo=3V Version)
- Output capacitor with ceramic capacitor
- Output Current Io(max.)=1.5A
- High Precision Output Vo \pm 1.0%
- Low Dropout Voltage 0.20V typ. (Io=1A)
- ON/OFF Control
- Internal Reverse Current Protection
- Internal Thermal Overload Protection
- Internal Over Current Protection
- Bipolar Technology
- Package Outline TO-252-5

■ PIN CONFIGURATION

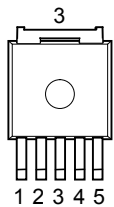

- 1.CONTROL
- 2.V_{IN}
- 3.GND
- 4.V_{OUT}
- 5.NC

NJM2857DL3

■ BLOCK DIAGRAM

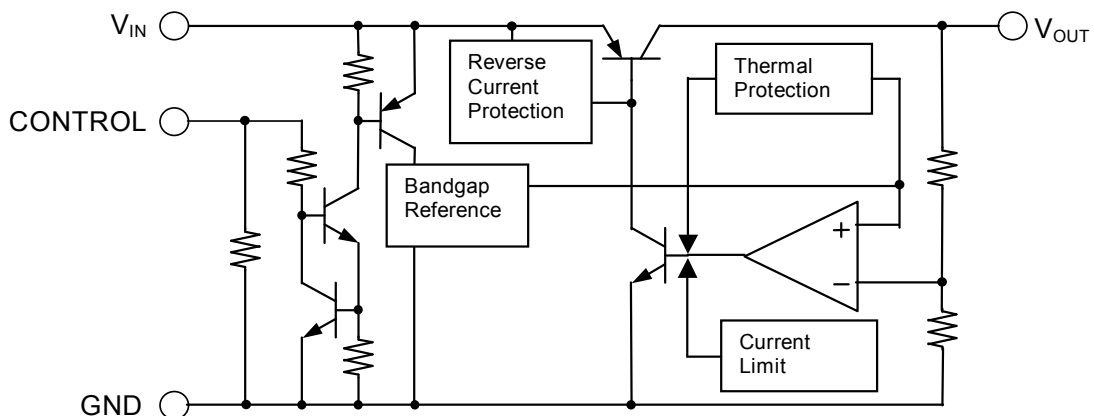

NJM2857

■ OUTPUT VOLTAGE

Device Name	V _{OUT}
NJM2857DL3-15	1.5V
NJM2857DL3-25	2.5V
NJM2857DL3-03	3.0V
NJM2857DL3-33	3.3V
NJM2857DL3-05	5.0V

Output voltage options available : 1.5 ~ 5.0V (0.1V step)

■ ABSOLUTE MAXIMUM RATINGS (Ta=25°C)

PARAMETER	SYMBOL	RATINGS	UNIT
Input Voltage	V _{IN}	+10	V
Control Voltage	V _{CONT}	+10	V
Output Terminal Voltage	V _{o,max}	V _o +1	V
Power Dissipation	P _D	1190(*1) 3125(*2)	mW
Operating Temperature	T _{opr}	-40 ~ +125	°C
Storage Temperature	T _{stg}	-40 ~ +150	°C

(*1): Mounted on glass epoxy board. (76.2×114.3×1.6mm: based on EIA/JDEC standard size, 2Layers, Cu area 100mm²)

(*2): Mounted on glass epoxy board. (76.2×114.3×1.6mm: based on EIA/JDEC standard, 4Layers)

(For 4Layers: Applying 74.2×74.2mm inner Cu area and a thermal via hole to a board based on JEDEC standard JESD51-5)

■ Operating voltage

V_{IN}=+2.6V(In case of V_o<2.4V) ~ +8.0V

■ POWER DISSIPATION vs. AMBIENT TEMPERATURE

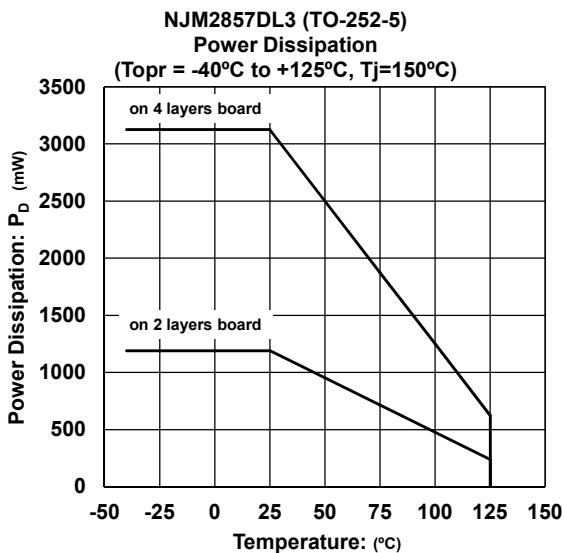

■ ELECTRICAL CHARACTERISTICS

($V_{IN}=V_o+1V$ ($V_o<1.6V$: $V_{IN}=2.6V$), $C_{IN}=1.0\mu F$, $C_o=4.7\mu F$ ($1.7V<V_o\leq 2.4V$: $C_o=10\mu F$, $V_o\leq 1.7V$: $C_o=22\mu F$), $T_a=25^\circ C$)

PARAMETER	SYMBOL	TEST CONDITION	MIN.	TYP.	MAX.	UNIT	
Output Voltage	V_o	$I_o=30mA$	-1.0%	-	+1.0%	V	
Input Voltage	V_{IN}		-	-	8	V	
Quiescent Current	I_Q	$I_o=0mA$	-	500	750	μA	
Quiescent Current at Control OFF	$I_{Q(OFF)}$	$V_{CONT}=0V$	-	-	100	nA	
Output Current	I_o	$V_o\times 0.9V$	1500	2000	-	mA	
Line Regulation	$\Delta V_o/\Delta V_{IN}$	$V_{IN}=V_o+1V \sim V_o+6V$ ($V_o\leq 2V$), $V_{IN}=V_o+1V \sim +8V$ ($V_o>2V$), $I_o=30mA$	-	-	0.10	%/V	
Load Regulation	$\Delta V_o/\Delta I_o$	$I_o=0 \sim 1500mA$	-	-	0.003	%/mA	
Dropout Voltage(*3)	ΔV_{I-O}	$I_o=1000mA$	-	0.20	0.30	V	
Ripple Rejection(*4)	RR	$e_{in}=200mV_{rms}$, $f=1kHz$, $I_o=10mA$	$V_o=1.5V$	-	86	-	dB
			$V_o=2.5V$	-	82	-	
			$V_o=3.0V$	-	80	-	
			$V_o=3.3V$	-	79	-	
			$V_o=5.0V$	-	78	-	
Average Temperature Coefficient of Output Voltage	$\Delta V_o/\Delta T_a$	$T_a=0 \sim 85^\circ C$, $I_o=10mA$	-	± 50	-	ppm/ $^\circ C$	
Output Noise Voltage	V_{NO}	$f=10Hz \sim 80kHz$, $I_o=10mA$,	$V_o=1.5V$	-	26	-	μV_{rms}
			$V_o=2.5V$	-	41	-	
			$V_o=3.0V$	-	47	-	
			$V_o=3.3V$	-	51	-	
			$V_o=5.0V$	-	69	-	
Control Current	I_{CONT}	$V_{CONT}=1.6V$	-	3	12	μA	
Control Voltage for ON-state	$V_{CONT(ON)}$		1.6	-	-	V	
Control Voltage for OFF-state	$V_{CONT(OFF)}$		-	-	0.6	V	

(*3): The output voltage excludes under 2.4V

(*4): $V_o>2.0V$: $V_{IN}=V_o+1V$, $V_o\leq 2.0V$: $V_{IN}=3.0V$

The above specification is a common specification for all output voltages.

Therefore, it may be different from the individual specification for a specific output voltage.

NJM2857

TEST CIRCUIT

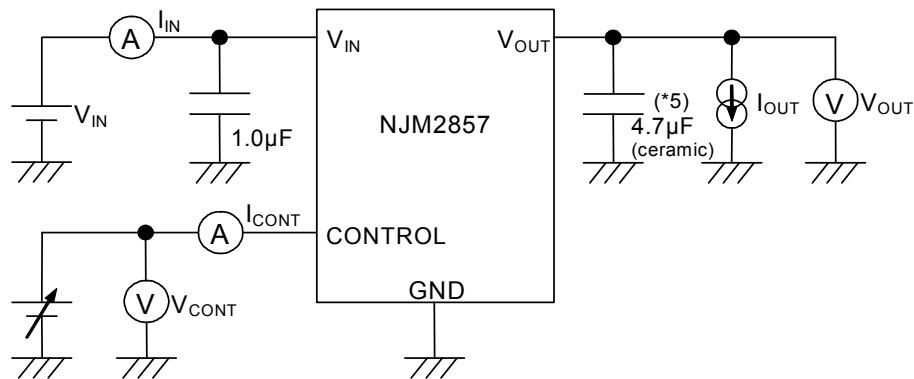

(*5) 1.7V < V_o ≤ 2.4V version: C_o = 10µF (ceramic)
 V_o ≤ 1.7V version: C_o = 22µF (ceramic)

TYPICAL APPLICATIONS

① In the case where ON/OFF Control is not required:

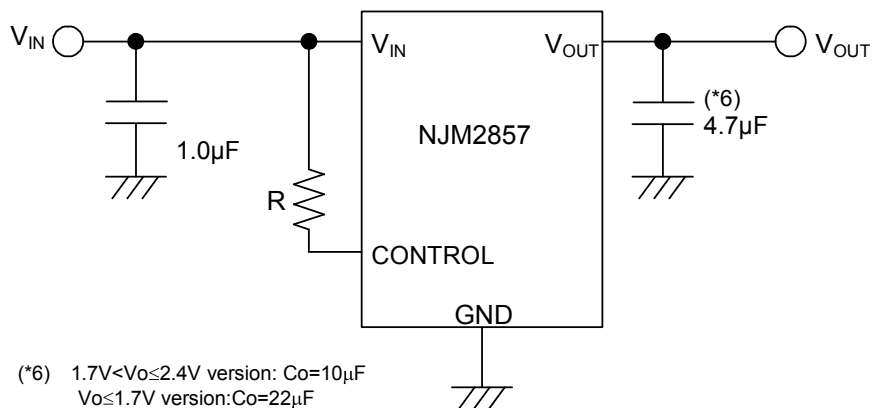

(*6) 1.7V < V_o ≤ 2.4V version: C_o = 10µF
 V_o ≤ 1.7V version: C_o = 22µF

Connect CONTROL pin to V_{IN} pin.

② In use of ON/OFF CONTROL:

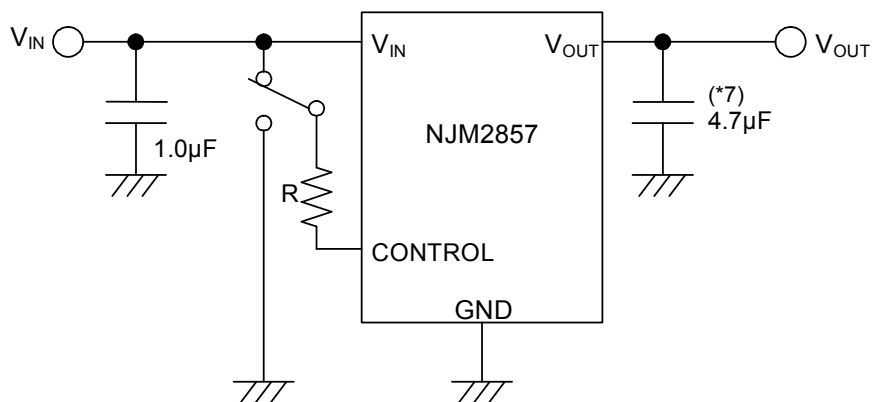

(*7) 1.7V < V_o ≤ 2.4V version: C_o = 10µF
 V_o ≤ 1.7V version: C_o = 22µF

State of CONTROL pin: "H" → output is enabled. "L" or "open" → output is disabled.

*In the case of using a resistance "R" between V_{IN} and control.

If this resistor is inserted, the control current could be reduced when the control voltage is high.

The applied voltage to control pin should set to consider voltage drop through the resistor "R" and the minimum control voltage for ON-state.

The $V_{CONT(ON)}$ and I_{CONT} have temperature dependence as shown in the "Control Current vs. Temperature" and "Control Voltage vs. Temperature" characteristics. Therefore, the resistor "R" should be selected to consider the temperature characteristics.

*Input Capacitor C_{IN}

Input Capacitor C_{IN} is required to prevent oscillation and reduce power supply ripple for applications when high power supply impedance or a long power supply line.

Therefore, use the recommended C_{IN} value (refer to conditions of ELECTRIC CHARACTERISTIC) or larger and should connect between GND and V_{IN} as shortest path as possible to avoid the problem.

*Output Capacitor C_O

Output capacitor (C_O) will be required for a phase compensation of the internal error amplifier.

The capacitance and the equivalent series resistance (ESR) influence to stable operation of the regulator.

Use of a smaller C_O may cause excess output noise or oscillation of the regulator due to lack of the phase compensation.

On the other hand, Use of a larger C_O reduces output noise and ripple output, and also improves output transient response when rapid load change.

Therefore, use the recommended C_O value (refer to conditions of ELECTRIC CHARACTERISTIC) or larger and should connect between GND and V_{OUT} as shortest path as possible for stable operation

The recommended capacitance depends on the output voltage rank. Especially, low voltage regulator requires larger C_O value.

In addition, you should consider varied characteristics of capacitor (a frequency characteristic, a temperature characteristic, a DC bias characteristic and so on) and unevenness peculiar to a capacitor supplier enough.

When selecting C_O , recommend that have withstand voltage margin against output voltage and superior temperature characteristic though this product is designed stability works with wide range ESR of capacitor including low ESR products.

*Reverse Current Protection

NJM2857 is built in Reverse Current Protection circuit.

So external Schottky barrier diode(SBD) is not required that this circuit prevents the large reverse current due to the output voltage being higher than the input voltage.

TYPICAL CHARACTERISTICS

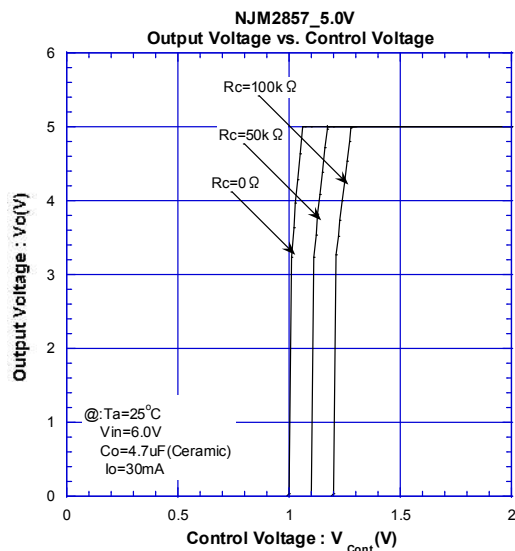
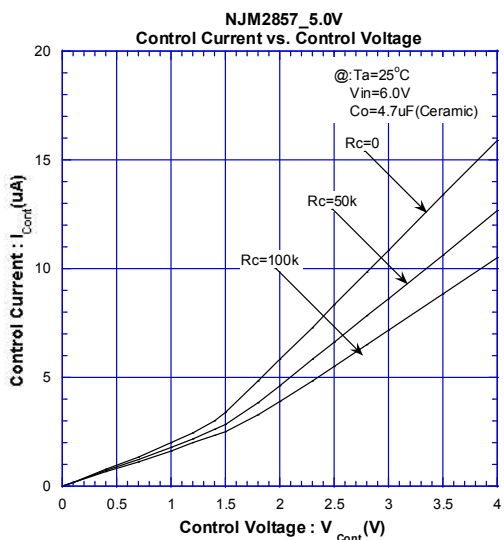
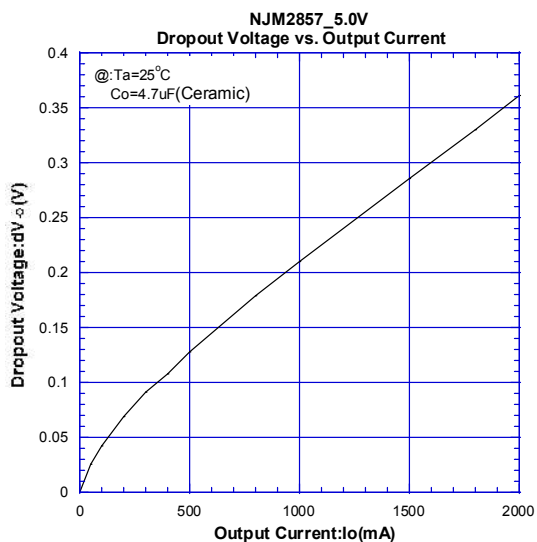
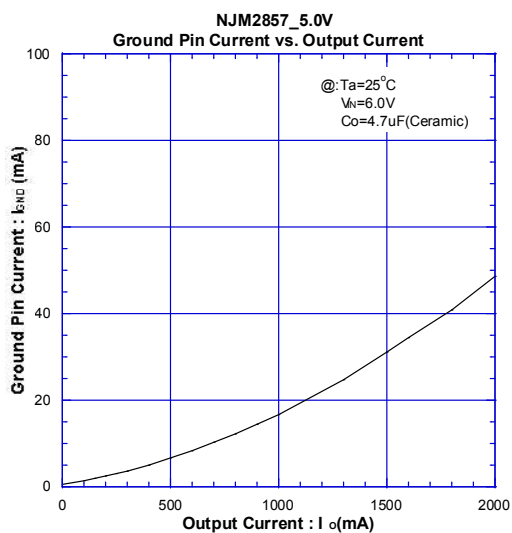
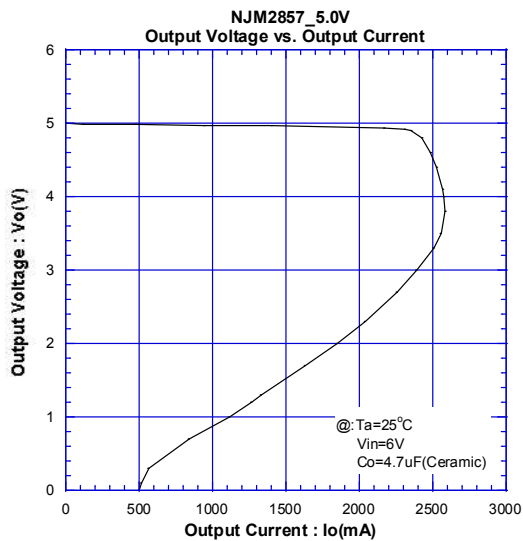
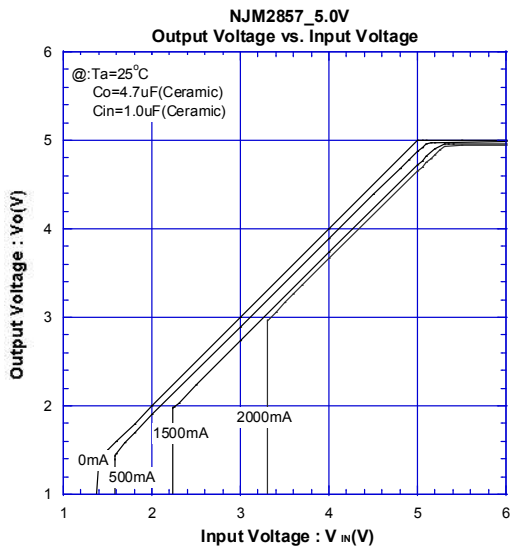

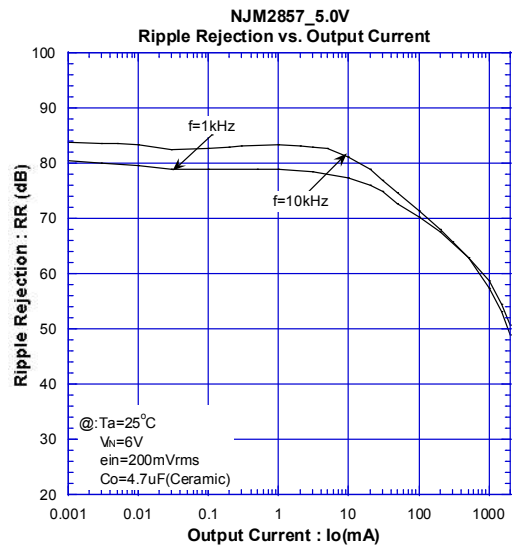
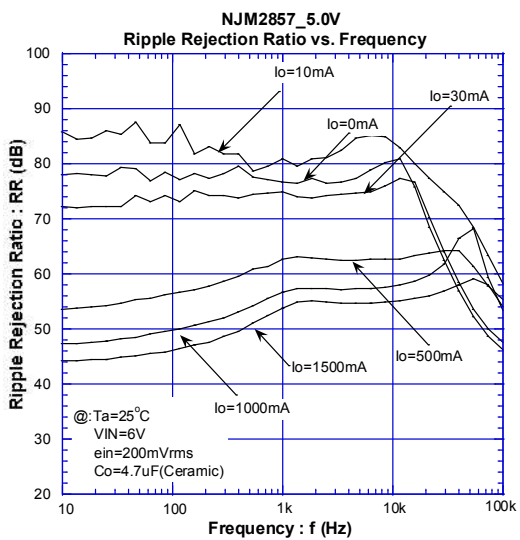
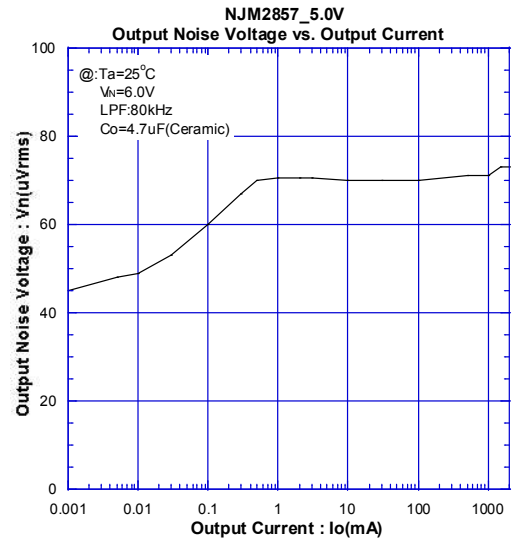
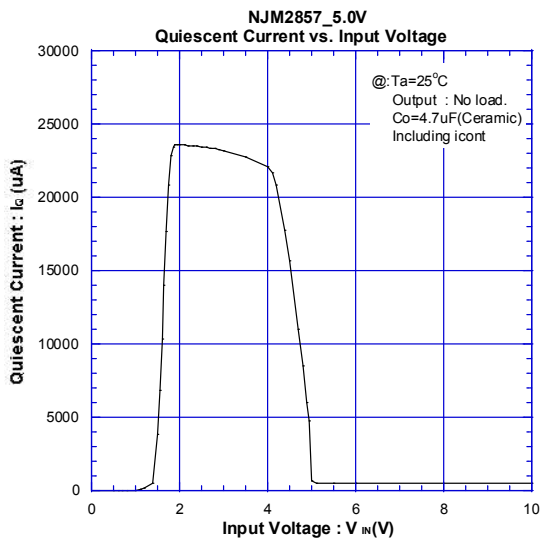
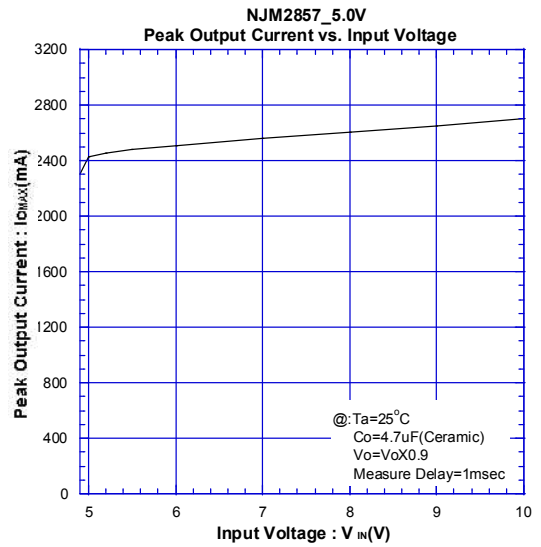
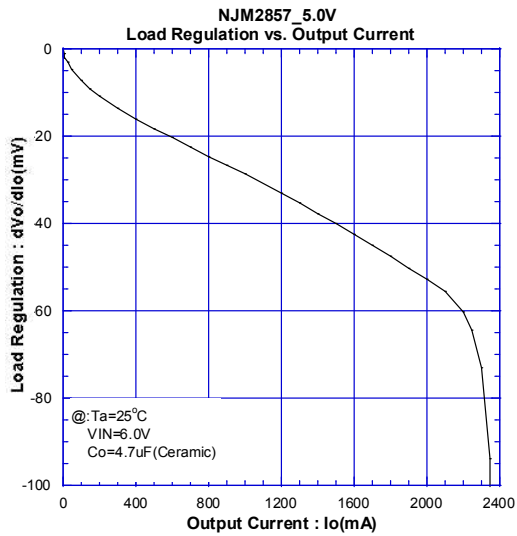

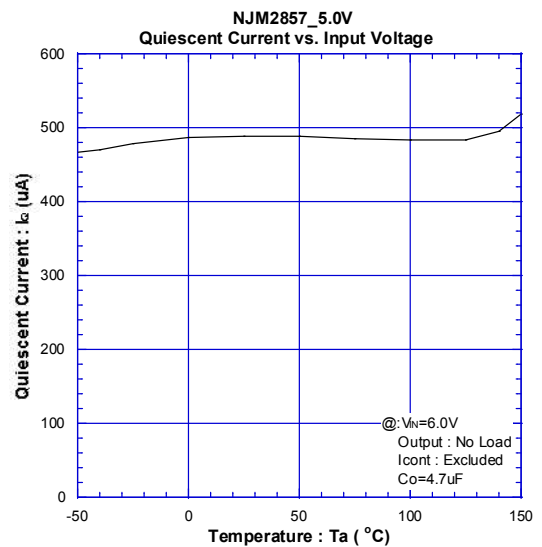
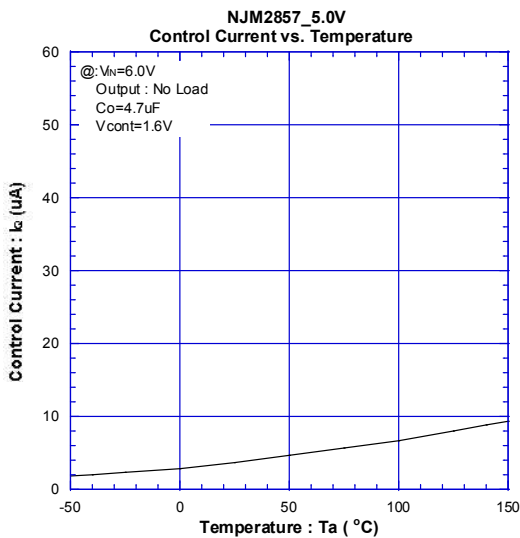
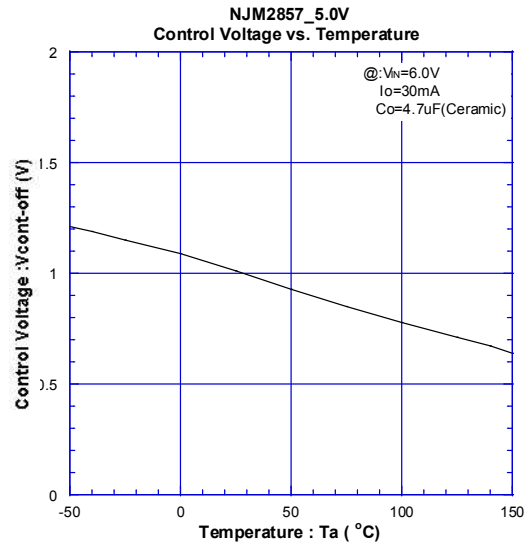
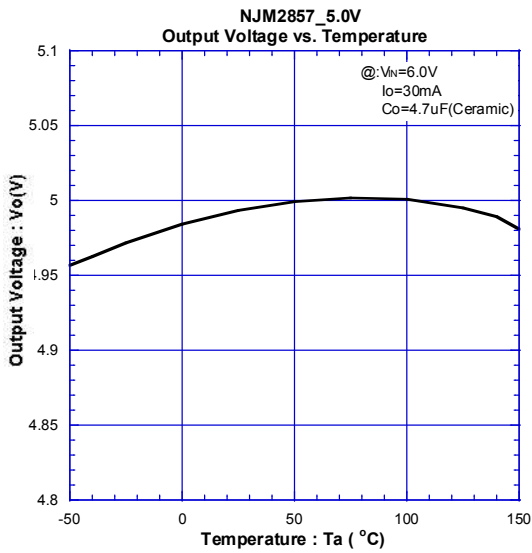
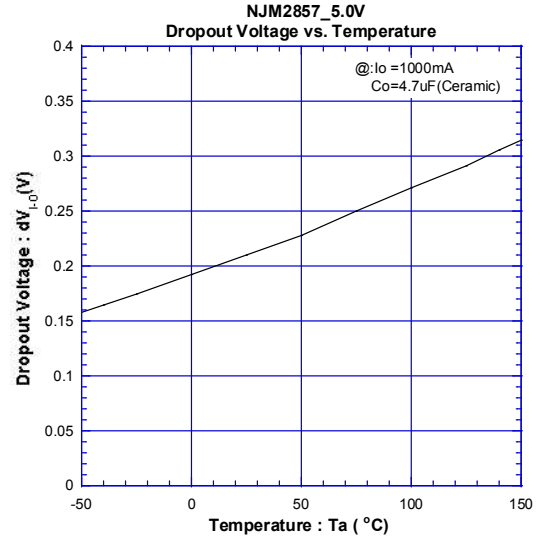
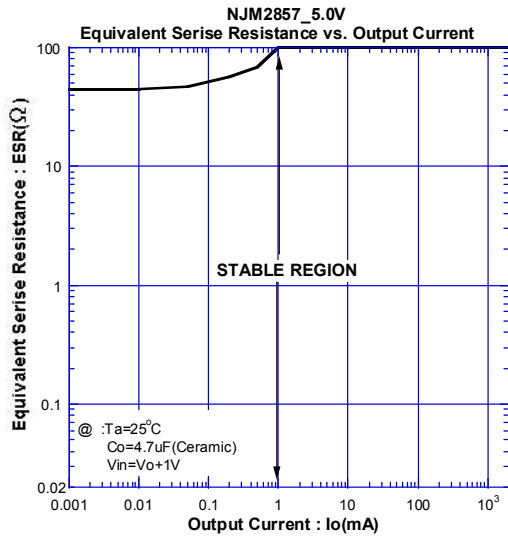

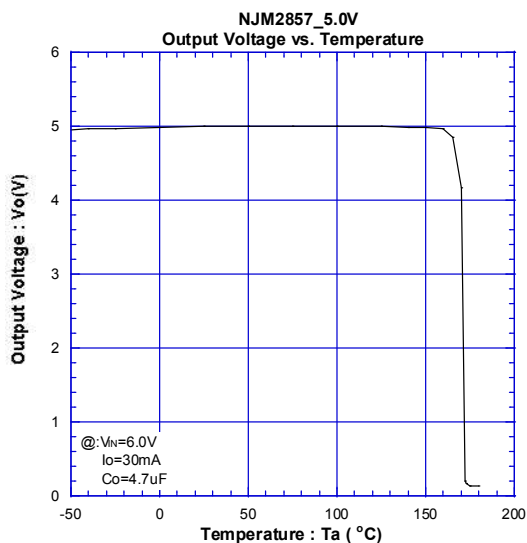
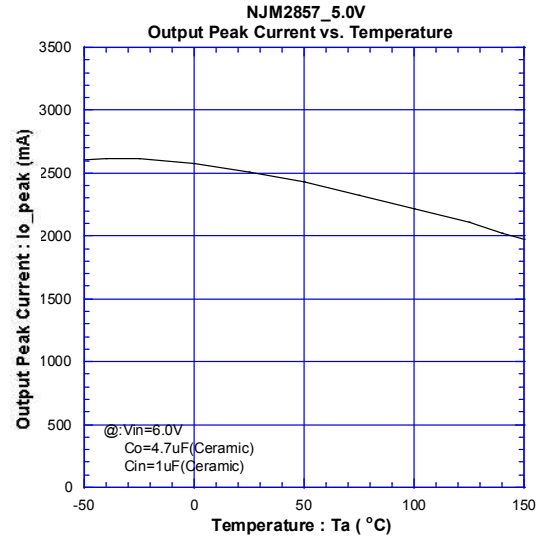
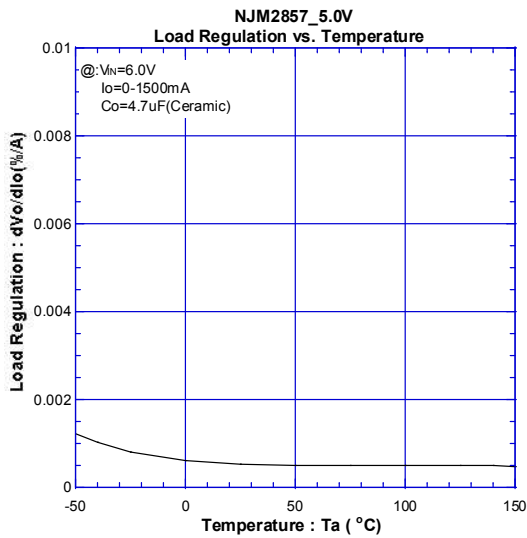
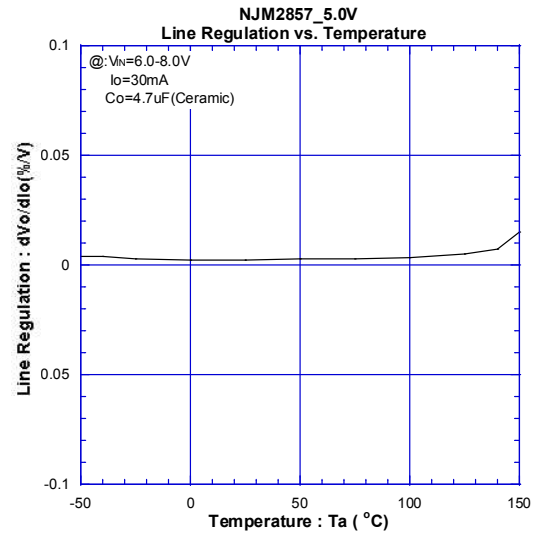
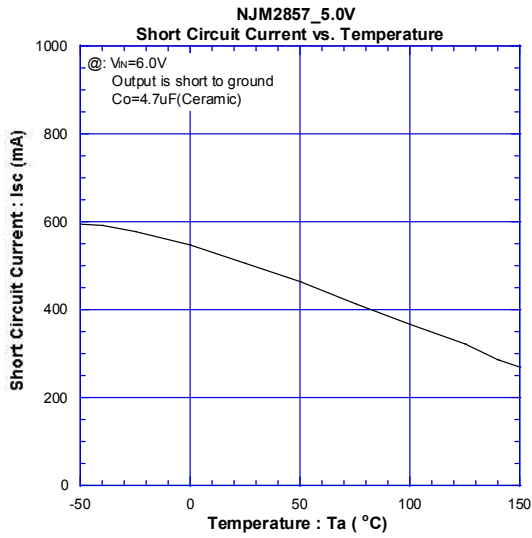

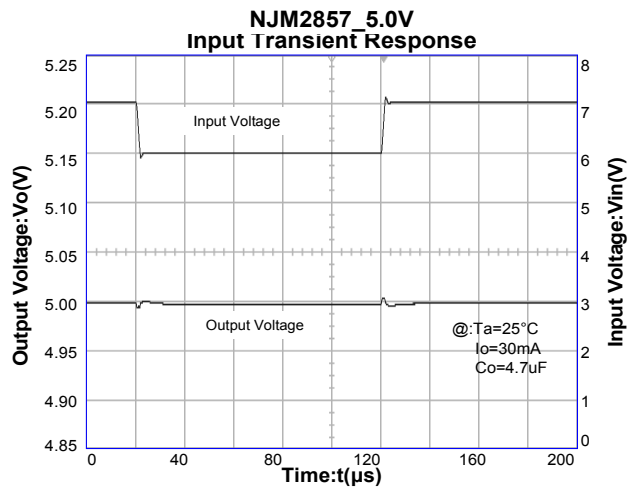
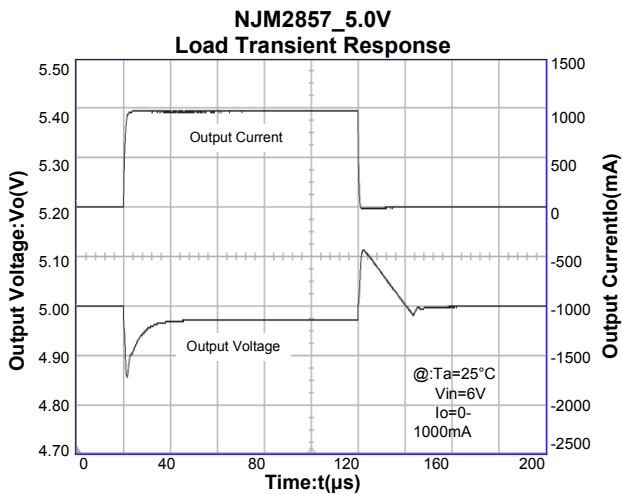
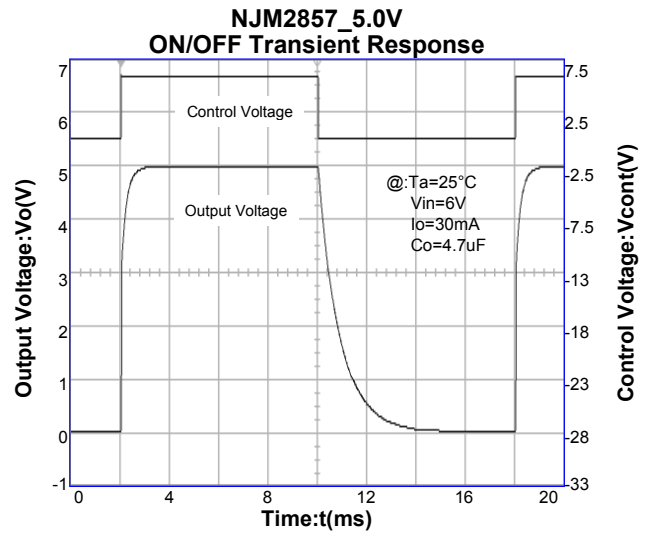
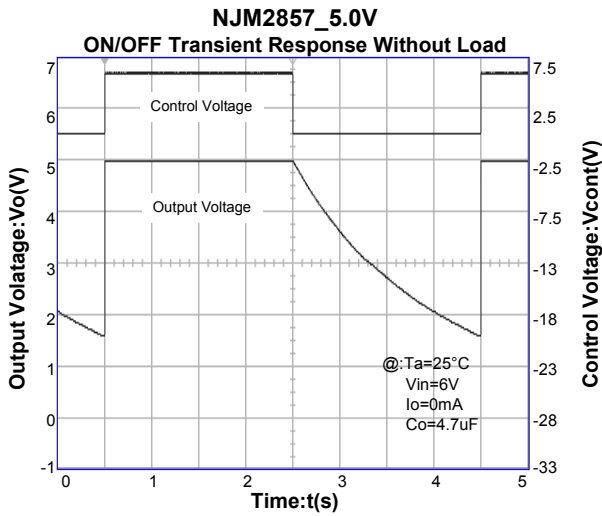

[CAUTION]

The specifications on this databook are only given for information, without any guarantee as regards either mistakes or omissions. The application circuits in this databook are described only to show representative usages of the product and not intended for the guarantee or permission of any right including the industrial rights.