

Very Low Output Negative Voltage Regulator

■ GENERAL DESCRIPTION

The NJM2829 is a negative voltage regulator that delivers up to 100mA output current with the output voltage of -0.8 to -1.3V with ON/OFF control.

Advanced Bipolar technology achieves low noise, high ripple rejection, and high precision voltage.

It has soft-start and shunt SW function. 2.2 μ F Output capacitor and small package can make NJM2829 suitable for portable items.

■ PACKAGE OUTLINE

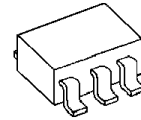

NJM2829F3

■ FEATURES

- High Precision Output $V_O \pm 1.5\%$
- High Ripple Rejection 80dB typ. (f=1kHz, $V_O = -1.0V$ version)
- Output Capacitor with 2.2 μ F ceramic capacitor
- Output Current $I_O(\text{max}) = 100\text{mA}$
- ON/OFF Control (Positive voltage control from 0V to +5V)
- Soft-start Function
- Shunt SW Function
- Built-in Thermal Overload Protection and Short Circuit Current Limit Protection
- Bipolar Technology
- Package Outline SC-88A

■ PIN CONNECTION

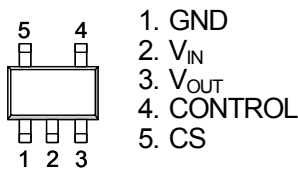

NJM2829F3

■ BLOCK DIAGRAM

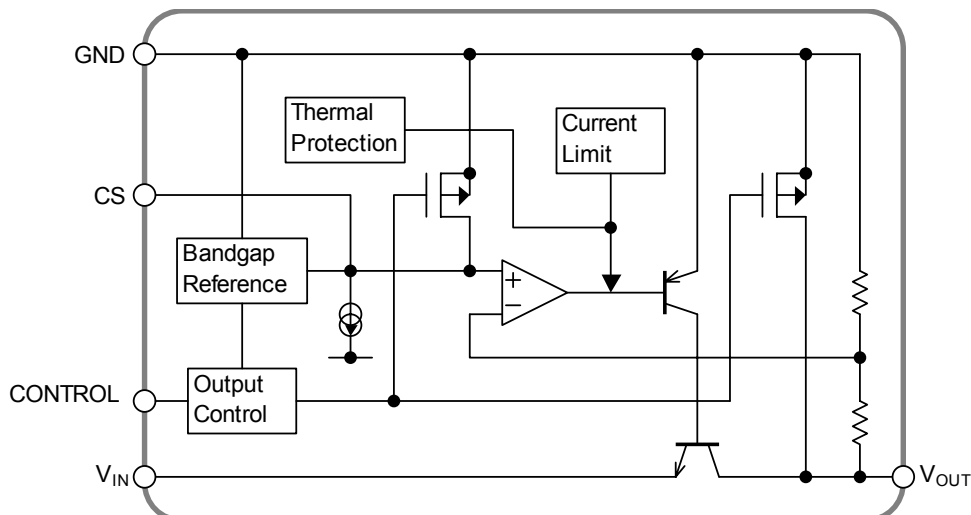

NJM2829

■ OUTPUT VOLTAGE RANK LIST

| Device Name | V_{out} |
|----------------|-----------|
| NJM2829F3 -080 | -0.8V |
| NJM2829F3 -095 | -0.95V |
| NJM2829F3 -100 | -1.0V |
| NJM2829F3 -120 | -1.2V |
| NJM2829F3 -130 | -1.3V |

Output Voltage Range: -0.8V to -1.3V

■ ABSOLUTE MAXIMUM RATINGS (Ta=25°C)

| PARAMETER | SYMBOL | RATINGS | UNIT |
|----------------------------------|-----------------|------------|------|
| Input Voltage | V_{IN} | -14 | V |
| Control Voltage | V_{CONT} | +5 | V |
| Output Sink Current at OFF-state | $I_{SINK(OFF)}$ | 10 | mA |
| Power Dissipation | P_D | 250(*1) | mW |
| Operating Temperature | T_{opr} | -40 ~ +85 | °C |
| Storage Temperature | T_{stg} | -40 ~ +125 | °C |

(*1): Mounted on glass epoxy board. (114.3×76.2×1.6mm : 2layer,FR-4)

■ OPERATING VOLTAGE RANGE

$V_{IN} = -3.2 \sim -12V$

■ ELECTRICAL CHARACTERISTICS

($V_{IN} = -3.2V$, $V_{CONT} = 3V$, $C_{IN} = 0.1\mu F$, $C_o = 2.2\mu F$ ($V_o > -0.9V$: $C_o = 4.7\mu F$), $T_a = 25^\circ C$)

| PARAMETER | SYMBOL | TEST CONDITION | MIN. | TYP. | MAX. | UNIT |
|---|------------------------------|---|-------|----------|-------|---------------|
| Output Voltage | V_o | $I_o = 30mA$ | -1.5% | - | +1.5% | V |
| Quiescent Current | I_Q | $I_o = 0mA$, except I_{cont} | - | 140 | 220 | μA |
| Quiescent Current at OFF-state | $I_{Q(OFF)}$ | $V_{CONT} = 0V$ | - | - | 100 | nA |
| Output Current | I_o | $V_o \times 0.9$ | 100 | 130 | - | mA |
| Line Regulation | $\Delta V_o / \Delta V_{IN}$ | $V_{IN} = V_o - 3.2V \sim -12V$, $I_o = 30mA$ | - | - | 0.10 | %/V |
| Load Regulation | $\Delta V_o / \Delta I_o$ | $I_o = 0 \sim 60mA$ | - | - | 0.04 | %/mA |
| Ripple Rejection | RR | $V_{IN} = -4.0V$, $e_{in} = 200mV_{rms}$, $f = 1kHz$, $I_o = 10mA$, $V_o = -1.0V$ Version | - | 80 | - | dB |
| Average Temperature Coefficient of Output Voltage | $\Delta V_o / \Delta T_a$ | $T_a = 0 \sim +85^\circ C$, $I_o = 10mA$ | - | ± 50 | - | ppm/°C |
| Output Noise Voltage | V_{NO} | $f = 10Hz \sim 80kHz$, $I_o = 10mA$, $V_o = -1.0V$ Version | - | 40 | - | μV_{rms} |
| CS Terminal Charge Current | I_{CS} | $V_{CS} = 0V$ | 4 | 5.3 | 6.5 | μA |
| Output Resistance at OFF-state | $R_{O(OFF)}$ | $V_{CONT} = 0V$ | - | 560 | - | Ω |
| Control Current | I_{CONT} | $V_{CONT} = 1.6V$ | - | 2 | 4 | μA |
| Control Voltage for ON-state | $V_{CONT(ON)}$ | | 1.6 | - | - | V |
| Control Voltage for OFF-state | $V_{CONT(OFF)}$ | | - | - | 0.6 | V |
| Input Voltage | V_{IN} | | -12 | - | - | V |

The above specification is a common specification for all output voltages.

Therefore, it may be different from the individual specification for a specific output voltage.

POWER DISSIPATION vs. AMBIENT TEMPERATURE

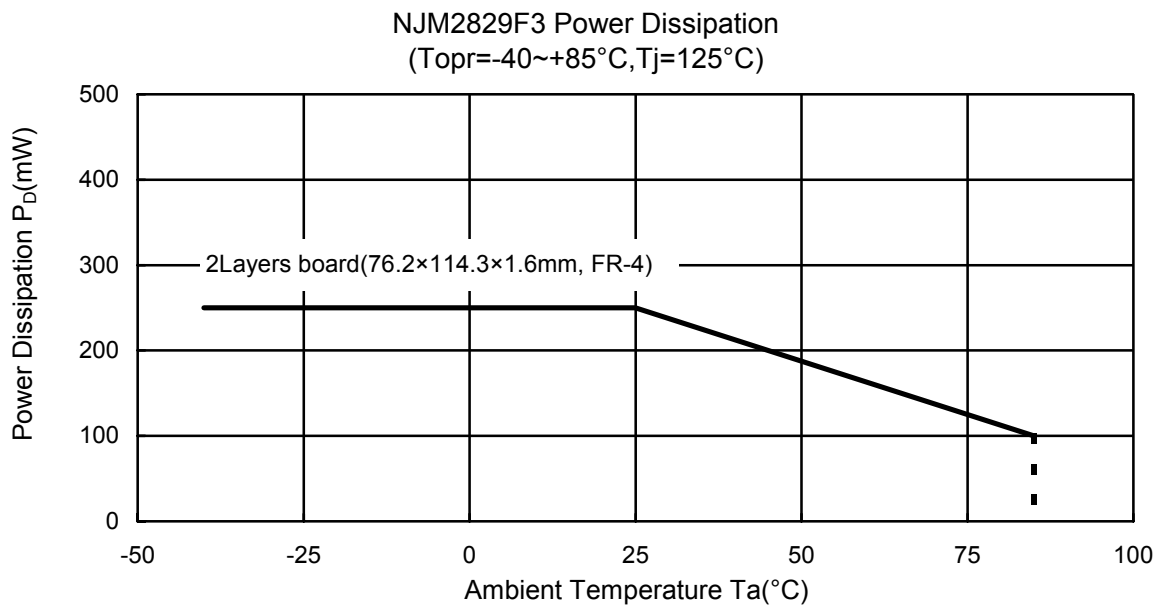

TEST CIRCUIT

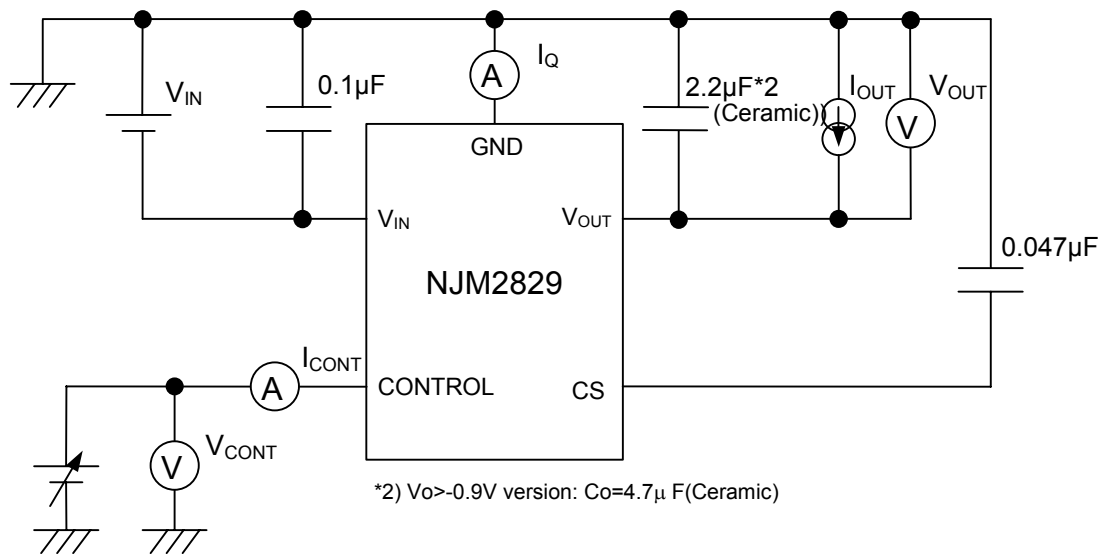

■ TYPICAL APPLICATION

*ON/OFF control

ON/OFF control can be achieved by applying positive control voltage to CONTROL terminal.

Apply positive V_{cont} ("H") to make chip to be ON (Enabled), and either V_{cont} is "L" or open (High Z) to make chip to be OFF (Disabled).

The relations between V_{cont} and the state is as follows:

| | |
|--|-----------|
| $V_{cont} +1.6V \leq V_{cont} \leq +5V$ ("H" level): | ON state |
| $V_{cont} 0V \leq V_{cont} \leq +0.6V$ ("L" level): | OFF state |
| $V_{cont} +0.6V < V_{cont} < +1.6V$ ("L" level): | Undefined |

In case ON/OFF control is not used, keep applying positive V_{cont} to CONTROL terminal to make chip ON.

Note that negative V_{cont} does not make the chip enabled.

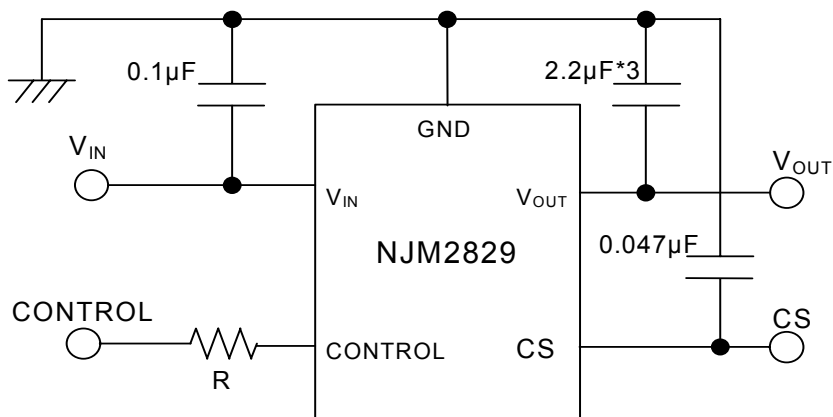

*3) $V_o > -0.9V$ version: $C_o = 4.7\mu F$ (Ceramic)

*In the case of using a resistance "R" to CONTROL terminal.

If this resistor is inserted, it can reduce the control current when the control voltage is high.

The applied voltage to control terminal should set to consider voltage drop through the resistor "R" and the minimum control voltage for ON-state.

The $V_{CONT(ON)}$ and I_{CONT} have temperature dependence as shown in the "Control Current vs. Temperature" and "Control Voltage vs. Temperature" characteristics.

Therefore, the resistance "R" should be selected to consider the temperature characteristics.

*Input Capacitor C_{IN}

Input Capacitor C_{IN} is required to prevent oscillation and reduce power supply ripple for applications when high power supply impedance or a long power supply line.

Therefore, use the recommended C_{IN} value (refer to conditions of ELECTRIC CHARACTERISTIC) or larger and should connect between GND and V_{IN} as shortest path as possible to avoid the problem.

*Output Capacitor C_O

Output capacitor (C_O) will be required for a phase compensation of the internal error amplifier.

The capacitance and the equivalent series resistance (ESR) influence to stable operation of the regulator.

Use of a smaller C_O may cause excess output noise or oscillation of the regulator due to lack of the phase compensation.

On the other hand, Use of a larger C_O reduces output noise and ripple output, and also improves output transient response when rapid load change.

Therefore, use the recommended C_O value (refer to conditions of ELECTRIC CHARACTERISTIC) or larger and should connect between GND and V_{OUT} as shortest path as possible for stable operation

The recommended capacitance depends on the output voltage rank. Especially, low voltage regulator requires larger C_O value.

In addition, you should consider varied characteristics of capacitor (a frequency characteristic, a temperature characteristic, a DC bias characteristic and so on) and unevenness peculiar to a capacitor supplier enough.

When selecting C_O , recommend that have withstand voltage margin against output voltage and superior temperature characteristic.

NJM2829

*Soft-start function

Capacitance Cs connects between CS pin and GND for the following.

- Control at risetime of output voltage.
- Reduces inrush current at output ON.

When the soft start function is not used, CS pin should be open.

Please switch ON/OFF with CONTROL pin by all means because when switch ON/OFF with VIN pin, the electric charge of the CS pin cannot discharge, and normalcy does not work a soft start circuit.

Cs capacitance vs. output voltage risetime

Calculation: output voltage risetime Δt (ms) \cong 82 x CS pin Capacitance (μ F)

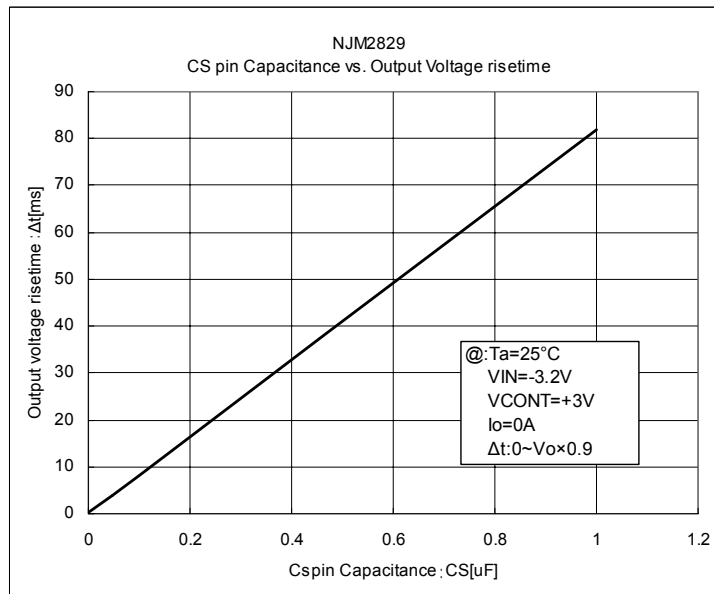

Please consider influence such as each temperature characteristic and dispersion enough.

Because depend on CS pin charge electric current and CS pin capacitance greatly in an output voltage risetime

TYPICAL CHARACTERISTICS

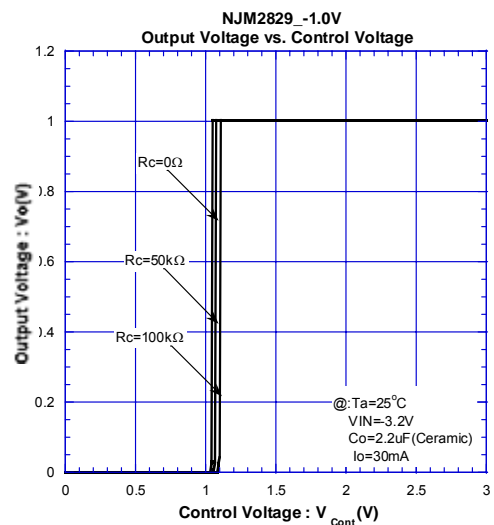
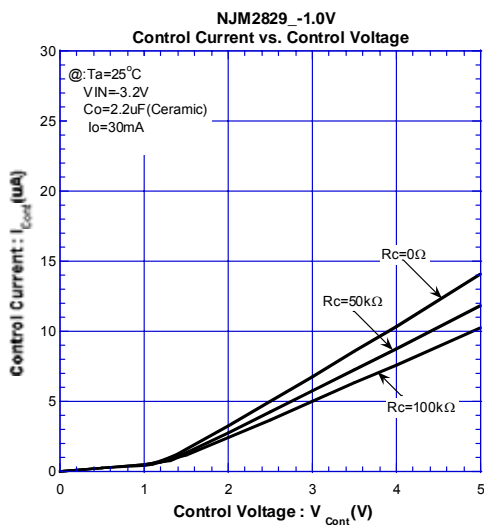
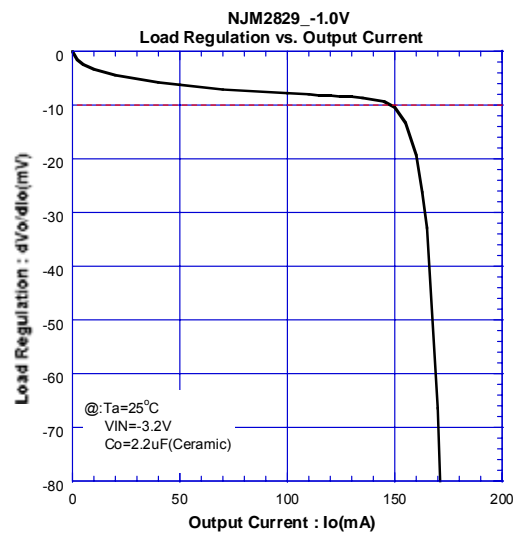
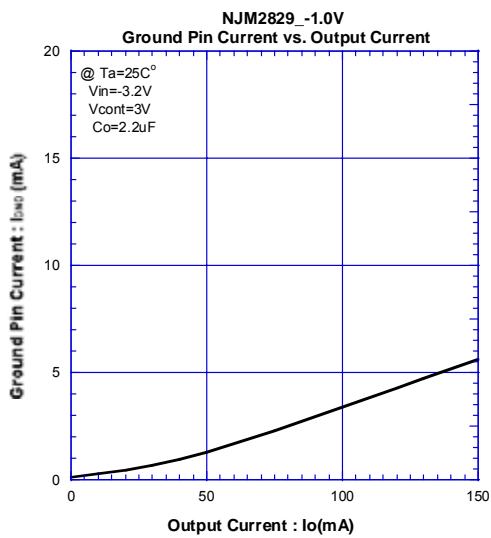
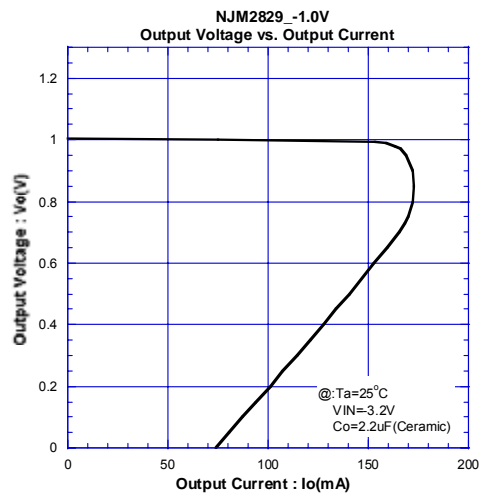
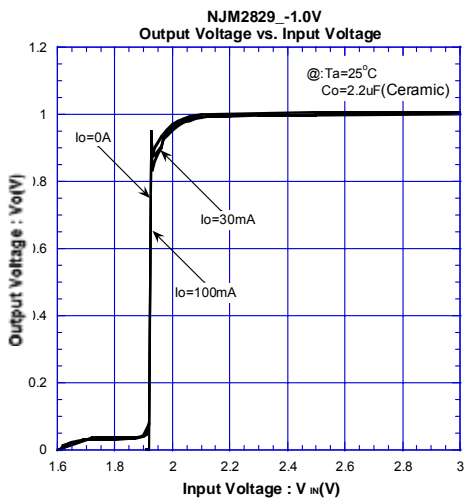

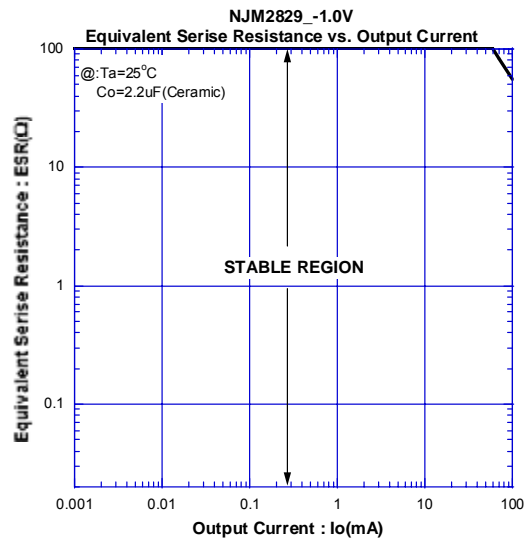
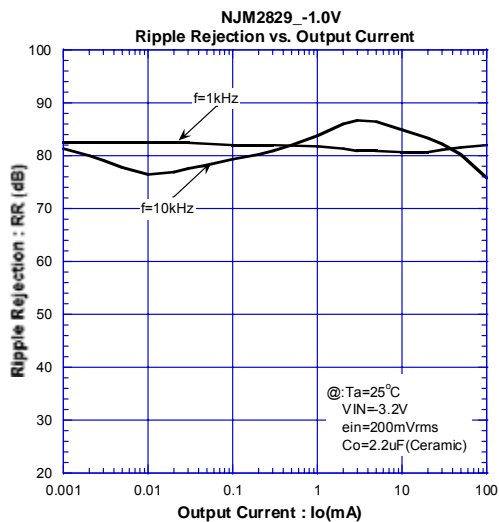
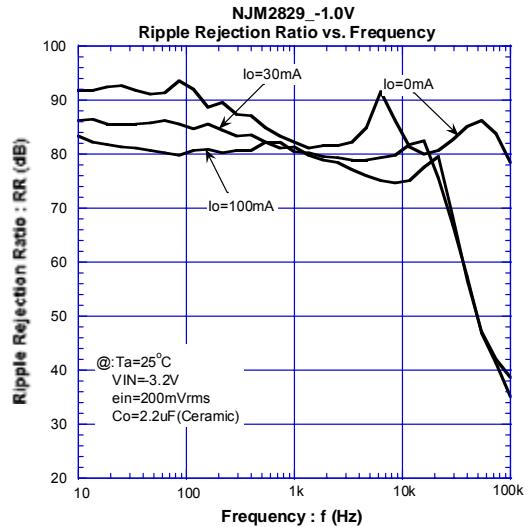
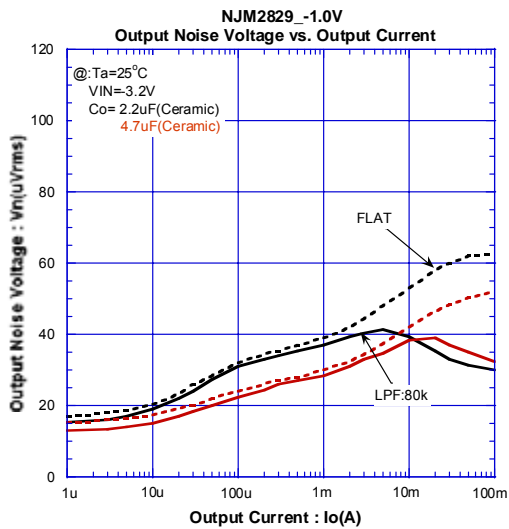
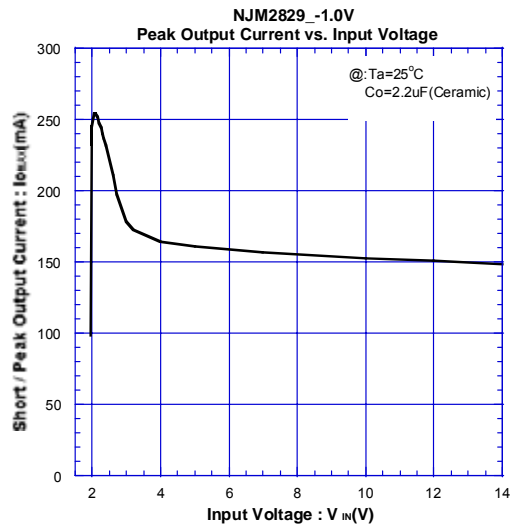
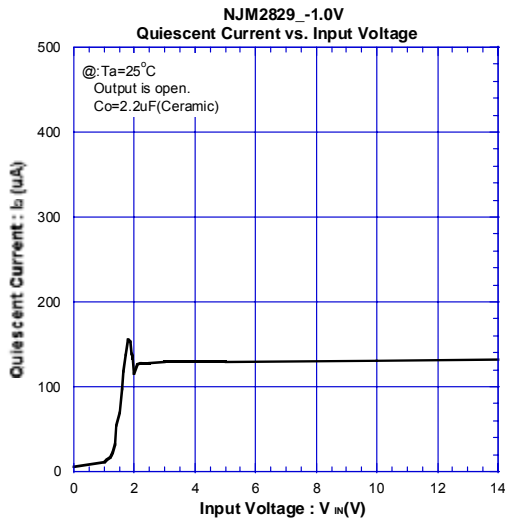

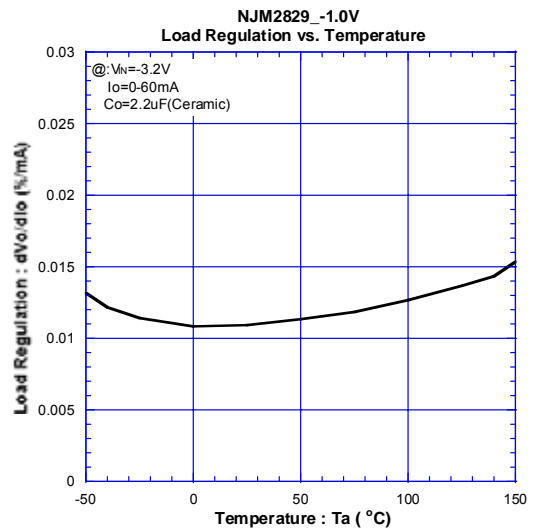
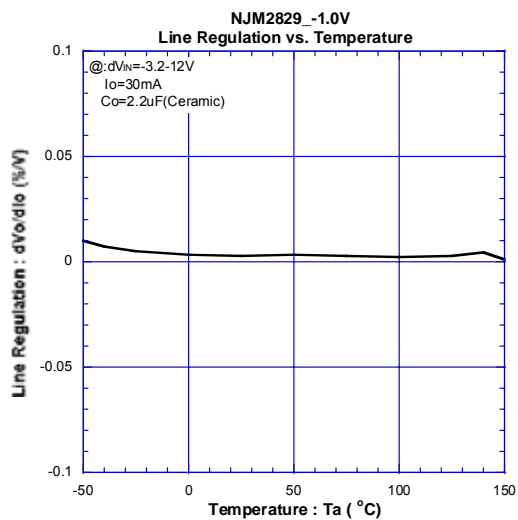
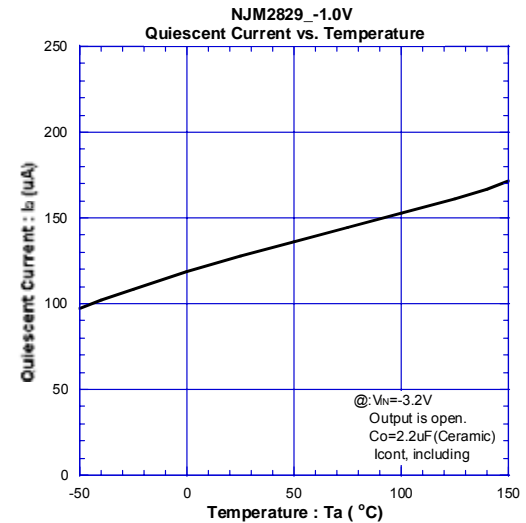
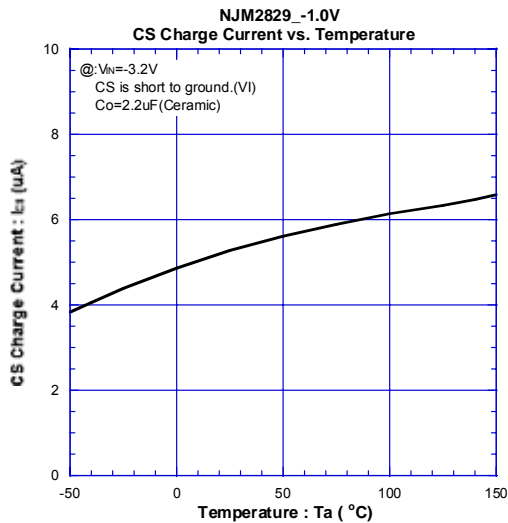
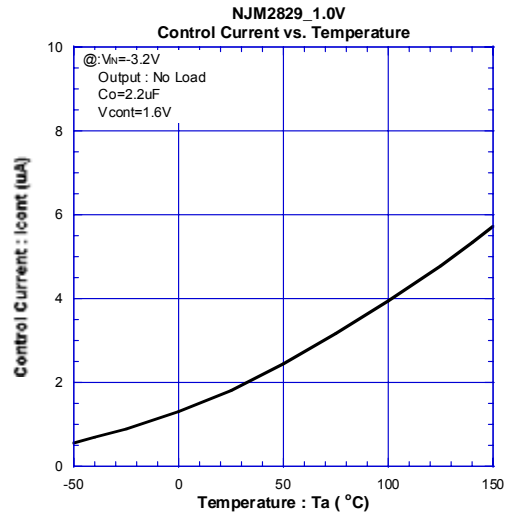
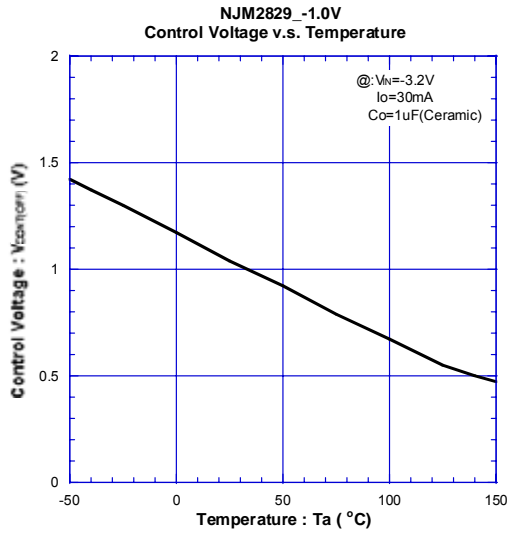

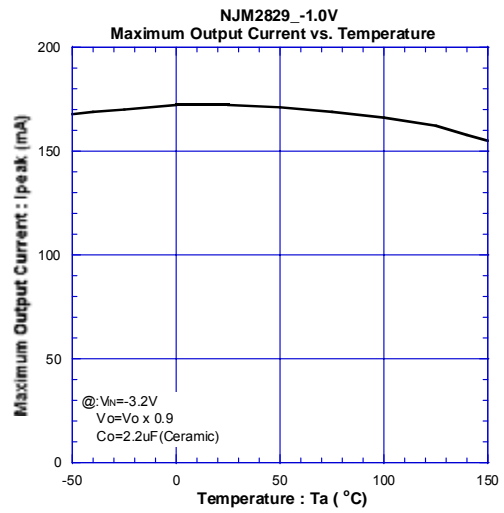
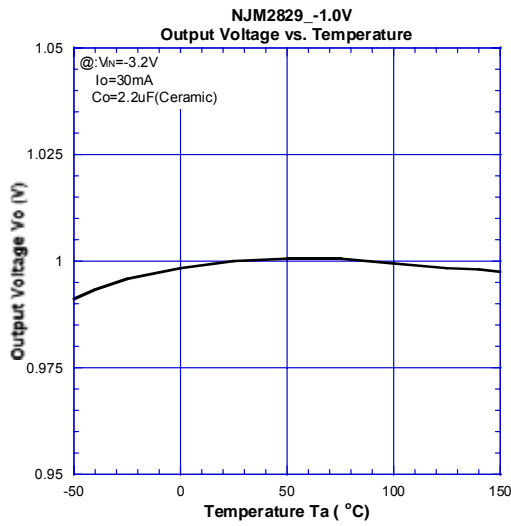
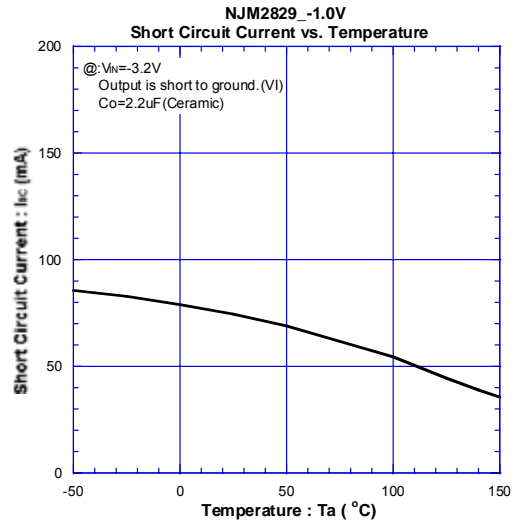
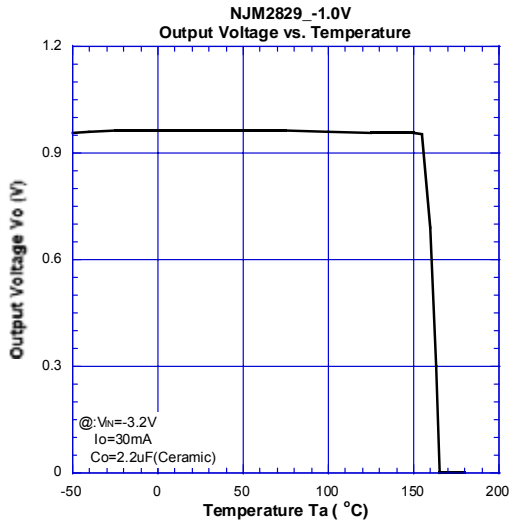

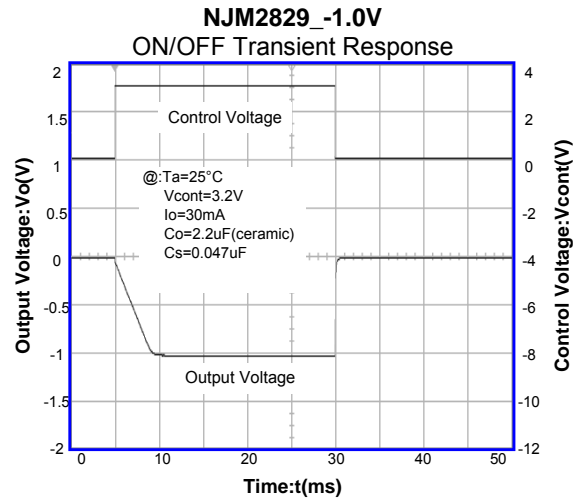
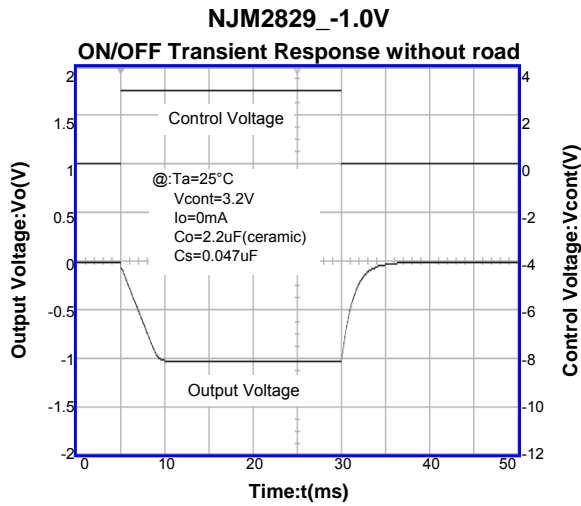
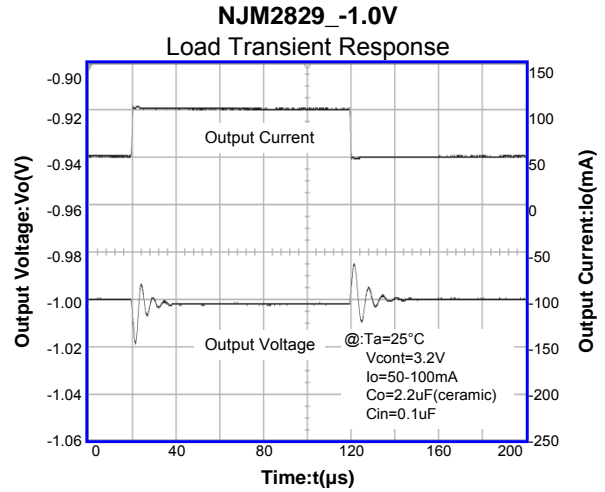
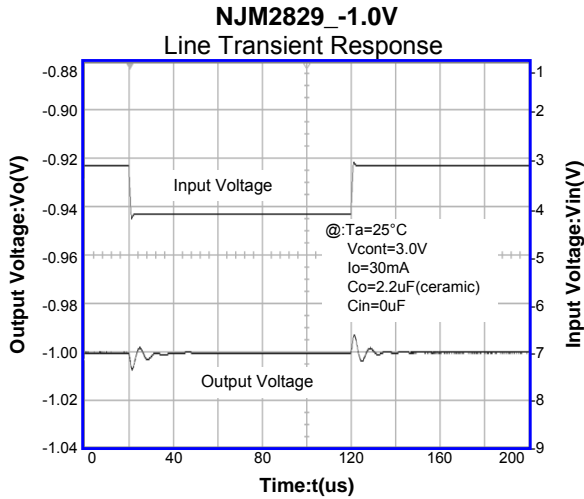

[CAUTION]

The specifications on this databook are only given for information, without any guarantee as regards either mistakes or omissions. The application circuits in this databook are described only to show representative usages of the product and not intended for the guarantee or permission of any right including the industrial rights.