

Negative Output Low Drop Out voltage regulator

■ GENERAL DESCRIPTION

The NJM2828 is a negative output low dropout regulator. Advanced bipolar technology achieves low noise, high precision voltage and high ripple rejection.

Adjustable soft-start function is useful for reducing inrush current and controlling power-on sequence. Moreover the discharge function, the shunt SW, makes effective sequence control with the soft-start function.

1.0 μ F Output capacitor and small package can make NJM2828 suitable for portable items.

■ PACKAGE OUTLINE

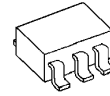

NJM2828F3

■ FEATURES

- Low Current Consumption 0.13V (typ.) @ $I_o=60\text{mA}$
- High Precision Output $\pm 1.5\%$
- High Ripple Rejection 65dB(typ.) @ $f=1\text{kHz}$, $V_o=-7\text{V}$ Version
- Correspond to Low ESR capacitor with 1.0F ceramic capacitor.
- Output Current $I_o(\text{max.})=100\text{mA}$
- ON/OFF Control(Positive voltage control from 0 to +5V)
- Soft-start Function
- Shunt SW Function
- Thermal Shutdown Circuit
- Over Current Protection
- Bipolar Technology
- Package Outline SC88A

■ PIN CONFIGURATION

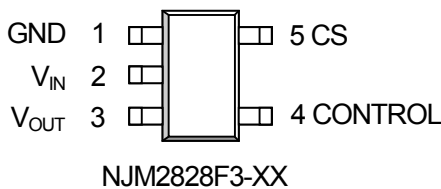

■ BLOCK DIAGRAM

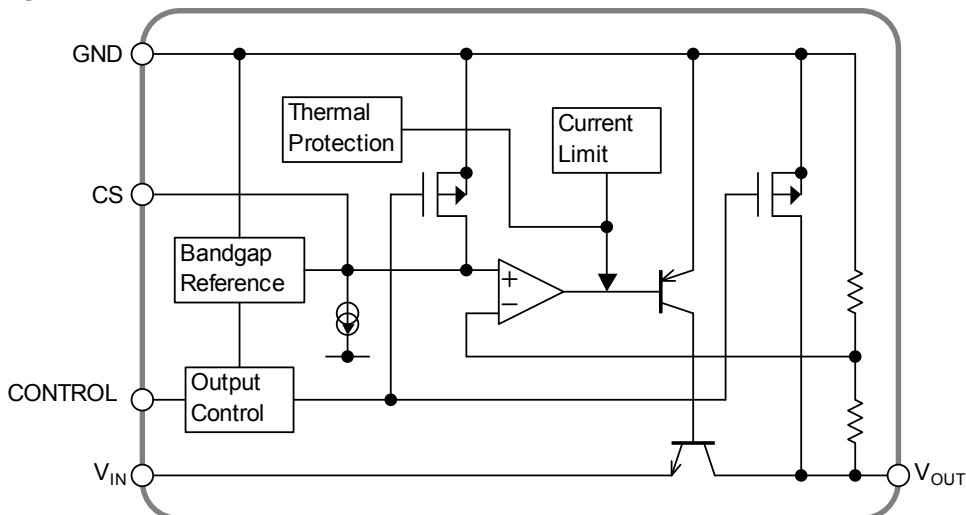

NJM2828

■ OUTPUT VOLTAGE RANK LIST

Device Name	V _{OUT}	Device Name	V _{OUT}
NJM2828F3-14	-1.4V	NJM2828F3-06	-6.0V
NJM2828F3-15	-1.5V	NJM2828F3-63	-6.3V
NJM2828F3-02	-2.0V	NJM2828F3-65	-6.5V
NJM2828F3-22	-2.2V	NJM2828F3-07	-7.0V
NJM2828F3-03	-3.0V	NJM2828F3-75	-7.5V
NJM2828F3-04	-4.0V	NJM2828F3-08	-8.0V
NJM2828F3-05	-5.0V	NJM2828F3-85	-8.5V
NJM2828F3-51	-5.1V	NJM2828F3-09	-9.0V
NJM2828F3-55	-5.5V	NJM2828F3-10	-10.0V

Output voltage options available : -1.5 ~ -10.0V (0.1V step)

■ ABSOLUTE MAXIMUM RATINGS (Ta=25°C)

PARAMETER	SYMBOL	RATINGS	UNIT
Input Voltage	V _{IN}	-14	V
Control Voltage	V _{CONT}	+5	V
Power Dissipation	P _D	250(*1)	mW
Operating Temperature	Topr	-40 ~ +85	°C
Storage Temperature	Tstg	-40 ~ +125	°C
Output Sink Current at OFF-state	I _{SINK(OFF)}	10	mA

(*1): Mounted on glass epoxy board. (76.2×114.3×1.6mm: based on EIA/JEDEC standard, 2Layers)

■ Operating voltage

V_{IN}=-3.2 ~ -12V (In case of Vo>-3.0V version)

■ ELECTRICAL CHARACTERISTICS

($V_o < -2.2V$ Version: $V_{IN} = V_o - 1V$, $V_{CONT} = 3V$, $C_{IN} = 0.1\mu F$, $C_o = 1.0\mu F$, $T_a = 25^\circ C$)

($V_o \geq -2.2V$ Version: $V_{IN} = -3.2V$, $V_{CONT} = 3V$, $C_{IN} = 0.1\mu F$, $C_o = 2.2\mu F$ ($V_o > -2.0V$: $C_o = 4.7\mu F$), $T_a = 25^\circ C$)

PARAMETER	SYMBOL	TEST CONDITION	MIN.	TYP.	MAX.	UNIT
Output Voltage	V_o	$I_o = 30mA$	+1.5%	-	-1.5%	V
Quiescent Current	I_Q	$I_o = 0mA$, except I_{cont}	-	130	200	μA
Quiescent Current at OFF-state	$I_{Q(OFF)}$	$V_{CONT} = 0V$	-	-	100	nA
Output Current	I_o	$V_o + 0.3V$	100	130	-	mA
Line Regulation	$\Delta V_o / \Delta V_{IN}$	$V_{IN} = V_o - 1V \sim -12V$, $I_o = 30mA$	-	-	0.10	%/V
Load Regulation	$\Delta V_o / \Delta I_o$	$I_o = 0 \sim 60mA$	-	-	0.03	%/mA
Dropout Voltage(*2)	ΔV_{I_O}	$I_o = 60mA$	-	0.13	0.23	V
Ripple Rejection	RR	$e_{in} = 200mV_{rms}$, $f = 1kHz$, $I_o = 10mA$ $V_o = -7V$ Version	-	65	-	dB
Average Temperature Coefficient of Output Voltage	$\Delta V_o / \Delta T_a$	$T_a = 0 \sim 85^\circ C$, $I_o = 10mA$	-	± 50	-	ppm/ $^\circ C$
Output Noise Voltage1	V_{NO}	$f = 10Hz \sim 80kHz$, $I_o = 10mA$, $V_o = -7V$ Version	-	100	-	μV_{rms}
CS Terminal Charge Current	I_{cs}	$V_{CS} = 0V$	4	5	6	μA
Output Resistance at OFF-state	$R_{O(OFF)}$	$V_{CONT} = 0V$, $V_o = -7V$ Version	-	360	-	Ω
Control Current	I_{CONT}	$V_{CONT} = 1.6V$	-	2	4	μA
Control Voltage for ON-state	$V_{CONT(ON)}$		1.6	-	-	V
Control Voltage for OFF-state	$V_{CONT(OFF)}$		-	-	0.6	V
Input Voltage	V_{IN}		-12	-	-	V

(*2): Excludes $V_o > -3.0V$ version.

The above specification is a common specification for all output voltages.

Therefore, it may be different from the individual specification for a specific output voltage.

■ TEST CIRCUIT

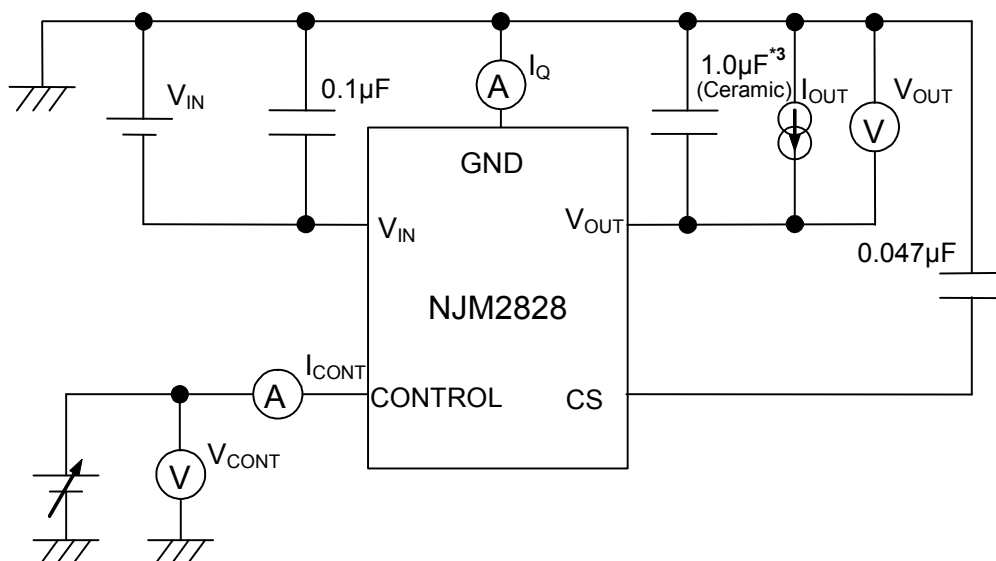

*3 $-2.2V \leq V_o < -2.0V$ version : $C_o = 2.2\mu F$ (Ceramic)
 $V_o \geq -2.0V$ version : $C_o = 4.7\mu F$ (Ceramic)

■ TYPICAL APPLICATIONS

*ON/OFF control

ON/OFF control can be controlled by positive logic voltage.

When V_{CONT} is "H", the output becomes ON state, If V_{CONT} is "L" or open (High Z), the output becomes OFF state.

The relations between V_{CONT} and the state is as follows:

$V_{\text{CONT}} + 1.6\text{V} \leq V_{\text{CONT}} \leq +5\text{V}$ ("H" level):	ON state
$V_{\text{CONT}} 0\text{V} \leq V_{\text{CONT}} \leq +0.6\text{V}$ ("L" level):	OFF state
$V_{\text{CONT}} + 0.6\text{V} < V_{\text{CONT}} < +1.6\text{V}$ ("L" level):	Undefined

If ON/OFF control is not used, keep applying positive V_{CONT} to CONTROL pin to make the output constantly ON.

Negative voltage should not use for V_{CONT} .

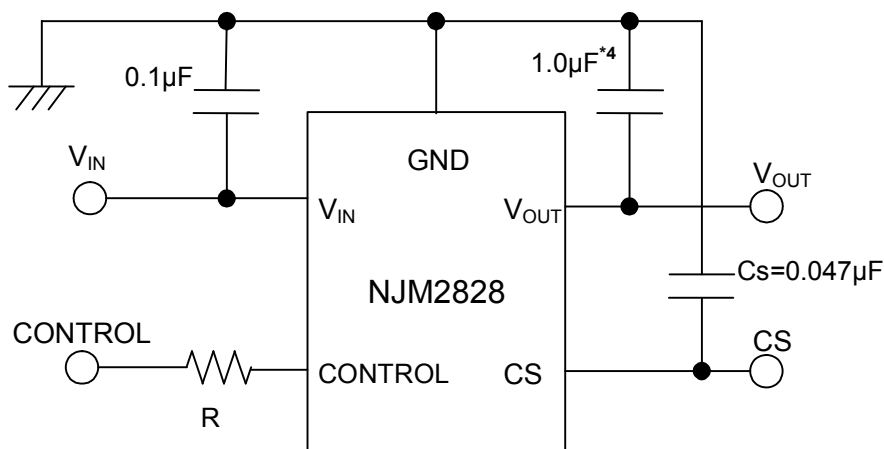

*4 $-2.2\text{V} \leq V_o < -2.0\text{V}$ version : $C_o = 2.2\mu\text{F}$
 $V_o \geq -2.0\text{V}$ version : $C_o = 4.7\mu\text{F}$

*In the case of using a resistor "R" to control line.

If need to reduce the control current when the control voltage, insert a resistor to control pin.

When insert the resistor "R", should consider voltage drop by the resistor. Therefore the control voltage should set in order to satisfy minimum $V_{\text{CONT(ON)}}$ with considering voltage drop.

The $V_{\text{CONT(ON)}}$ and I_{CONT} have temperature dependence as shown in "Control Current vs. Temperature" and "Control Voltage vs. Temperature" characteristics. Therefore, the resistance "R" should be selected to consider the temperature characteristics.

*Input Capacitor C_{IN}

The input capacitor C_{IN} is required in order to prevent oscillation and reduce power supply ripple of applications when high power supply impedance or a long power supply line.

Therefore, the recommended capacitance (refer to conditions of ELECTRIC CHARACTERISTIC) or larger input capacitor, connected between V_{IN} and GND as short path as possible, is recommended in order to avoid the problem.

*Output Capacitor C_O

The output capacitor C_O is required for a phase compensation of the internal error amplifier, and the capacitance and the equivalent series resistance (ESR) influence stable operation of the regulator.

If use a smaller output capacitor than the recommended capacitance (refer to conditions of ELECTRIC CHARACTERISTIC), it may cause excess output noise or oscillation of the regulator due to lack of the phase compensation. Therefore, the recommended capacitance or larger output capacitor, connected between V_{OUT} and GND as short path as possible, is recommended for stable operation. The recommended capacitance may be different by output voltage, therefore confirm the recommended capacitance of the required output voltage.

Furthermore, a larger output capacitor reduces output noise and ripple output, and also improves Output Transient Response when a load changes rapidly.

Selecting the output capacitor, should consider varied characteristics of a capacitor: frequency characteristics, temperature characteristics, DC bias characteristics and so on. Therefore, the capacitor that has a sufficient margin of the rated voltage against the output voltage and superior temperature characteristics, is recommended for C_O .

*Soft-start function

The capacitor C_s , that is connected between CS pin and GND, controls the following:

- The rising time of output voltage.
- The inrush current at start-up.

When the soft start function is not used, CS pin should be open.

1. C_s capacitance vs rise time of output voltage

The rise time of output voltage is calculated as follows:

$$\Delta t \text{ (ms)} \cong 213 \times C_s \text{ (\mu F)}$$

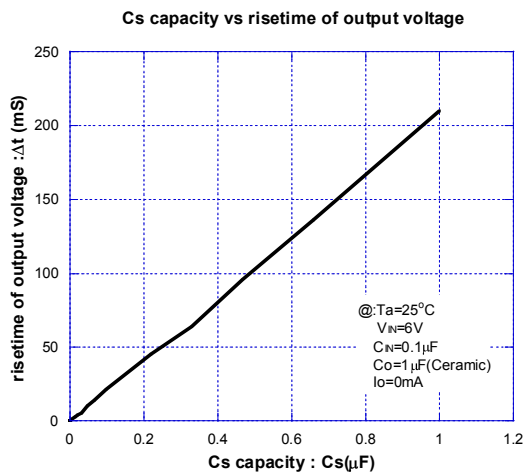

2. Inrush current at start-up

The peak value of the inrush current can be limited according to the capacitance of the C_s .

Inrush current wave :

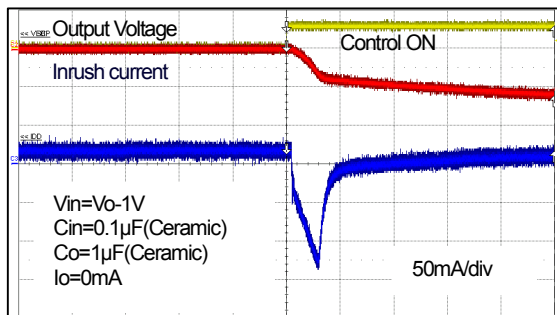

Peak current: 150mA at $C_S=0\mu F$

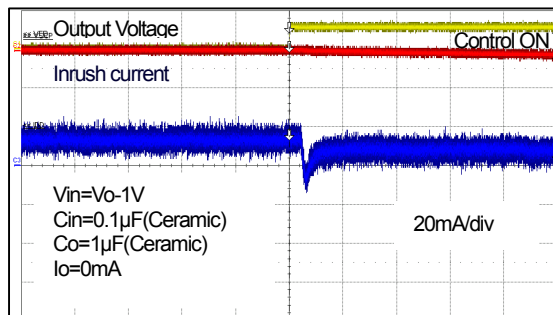

Peak current: 20mA at $C_S=0.0047\mu F$

* This characteristic is one example. It is necessary to examine the characteristic with an actual circuit because there is an influence by the characteristic such as output voltage/output capacitor.

POWER DISSIPATION vs. AMBIENT TEMPERATURE

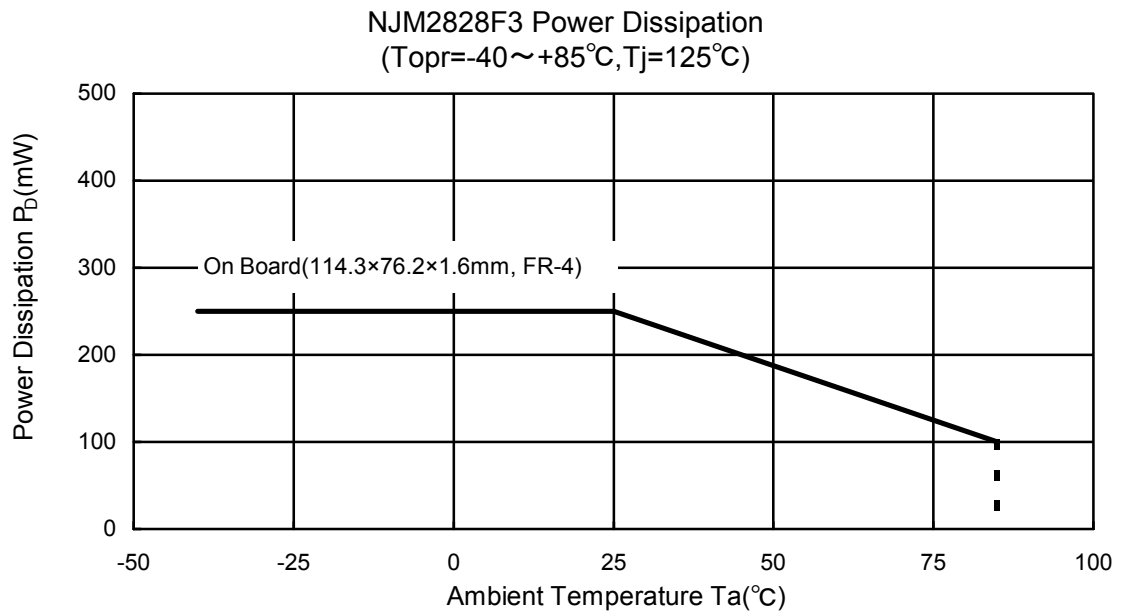

ELECTRICAL CHARACTERISTICS

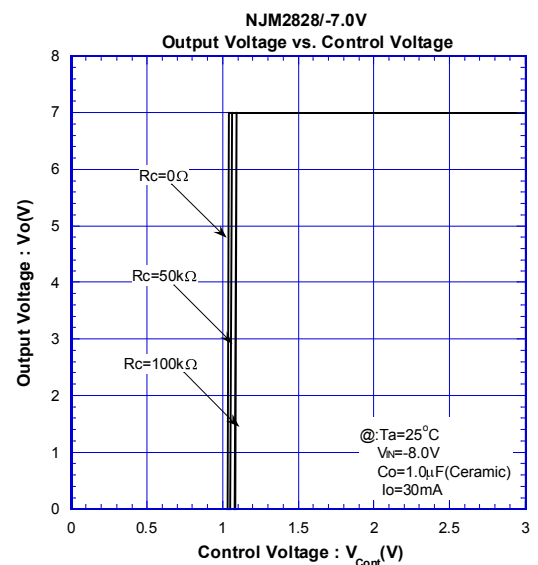
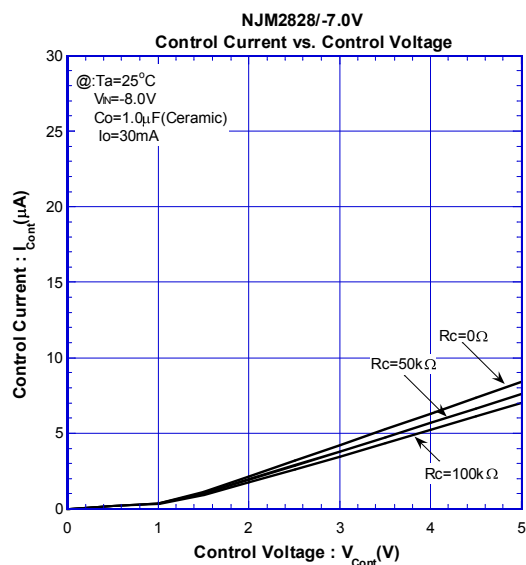
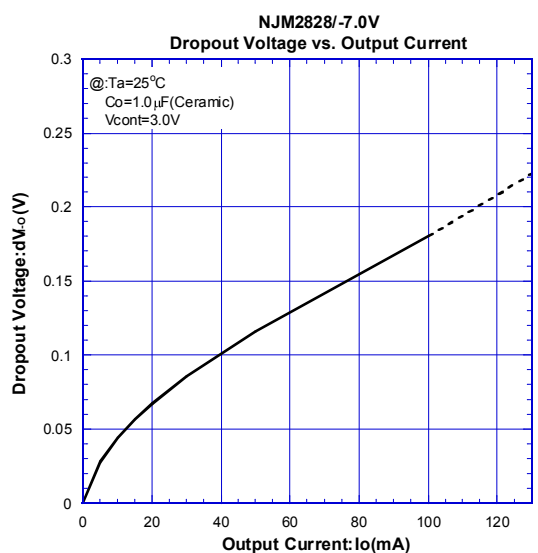
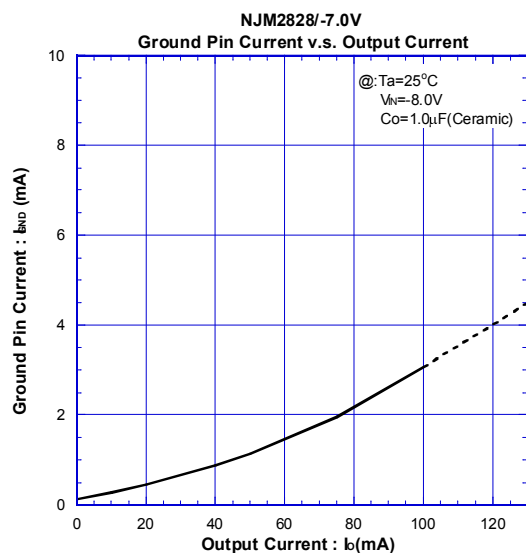
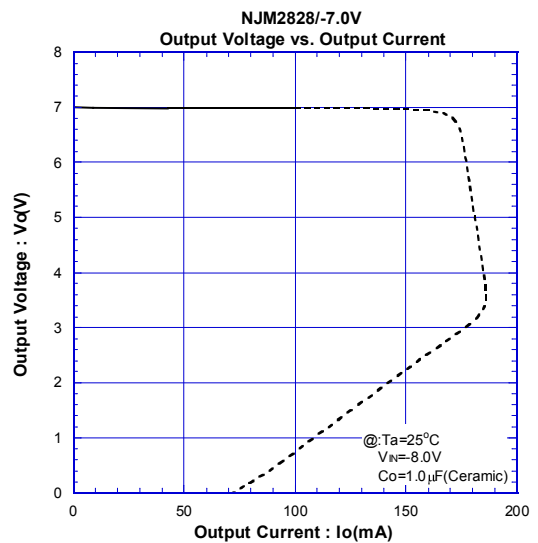
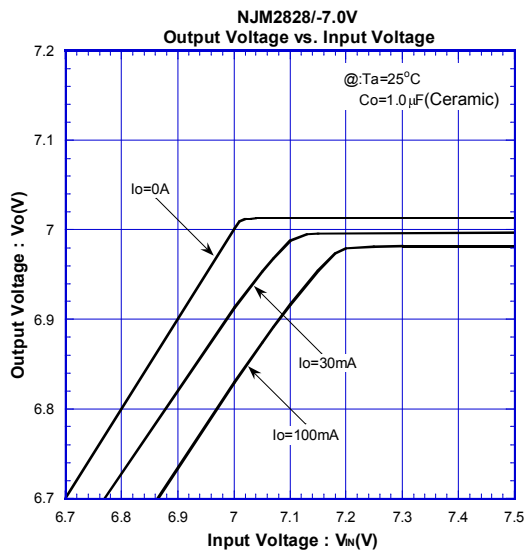

ELECTRICAL CHARACTERISTICS

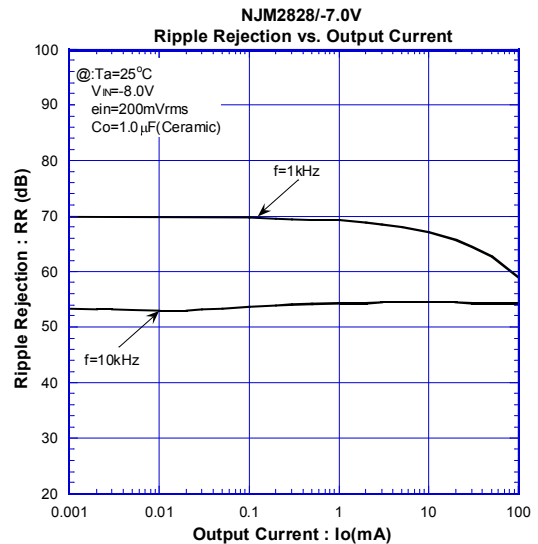
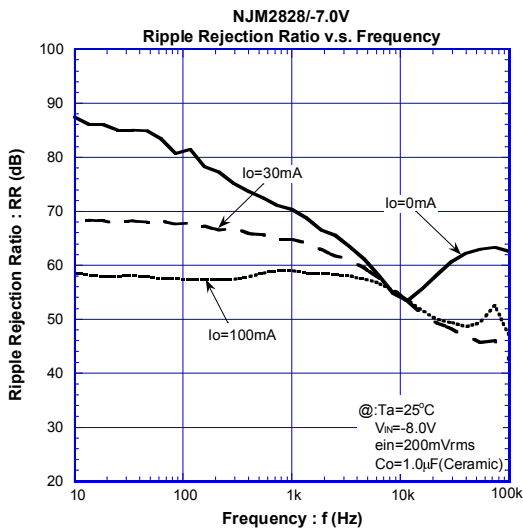
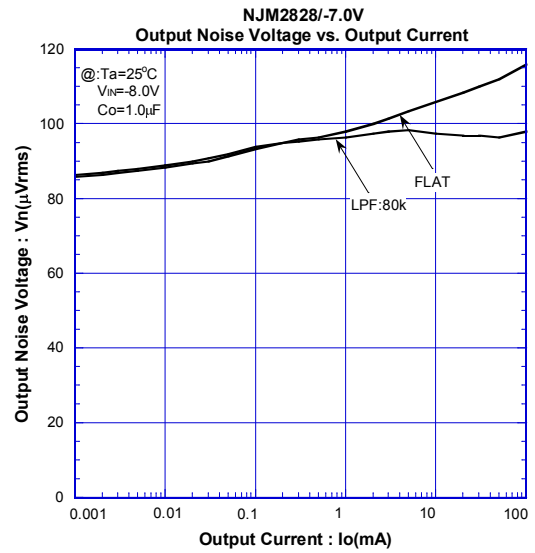
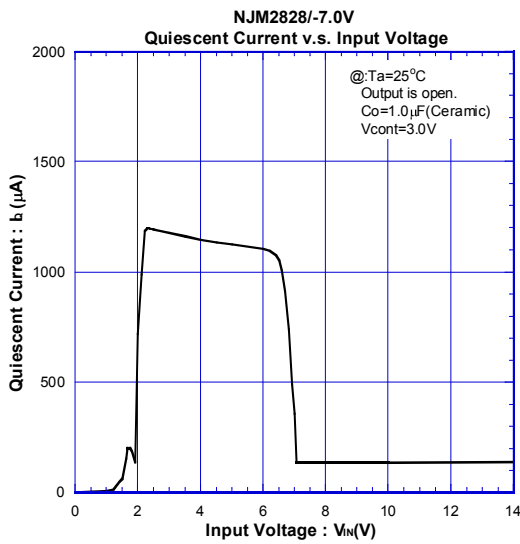
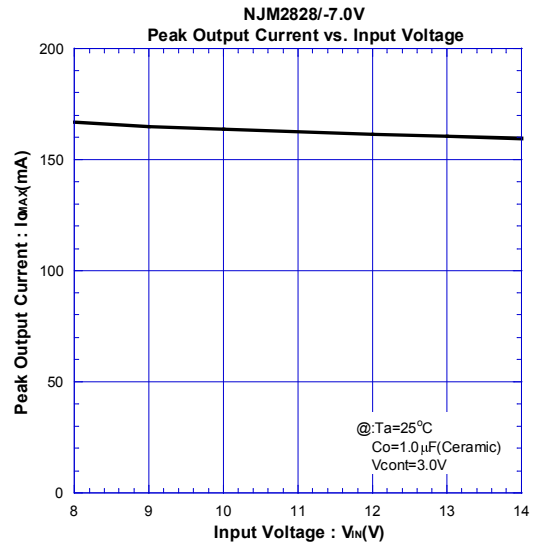
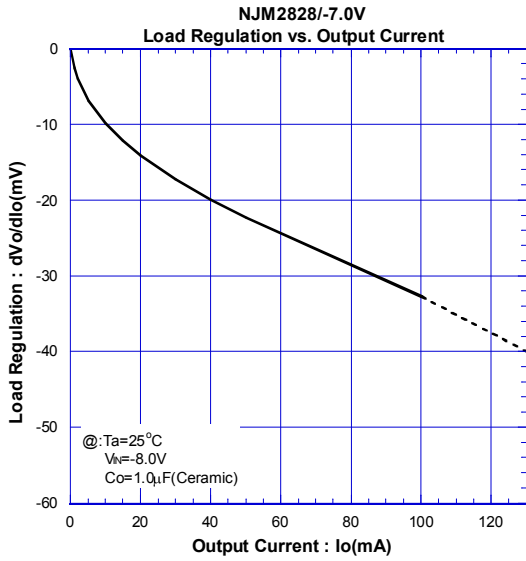

ELECTRICAL CHARACTERISTICS

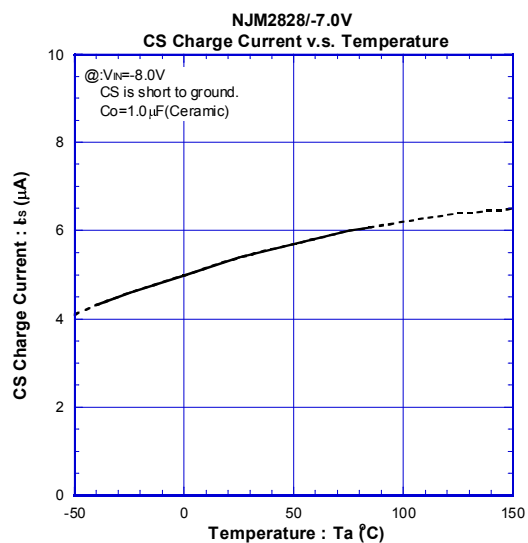
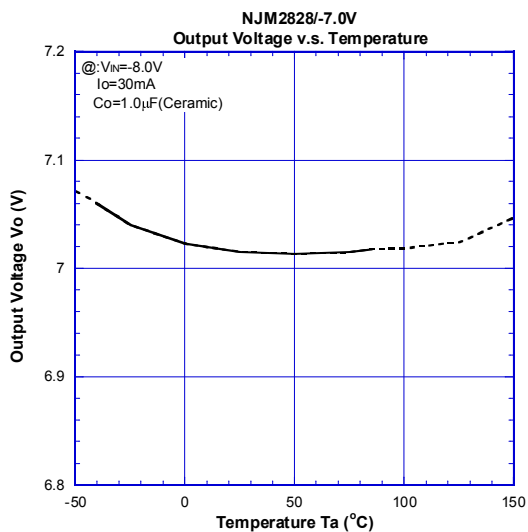
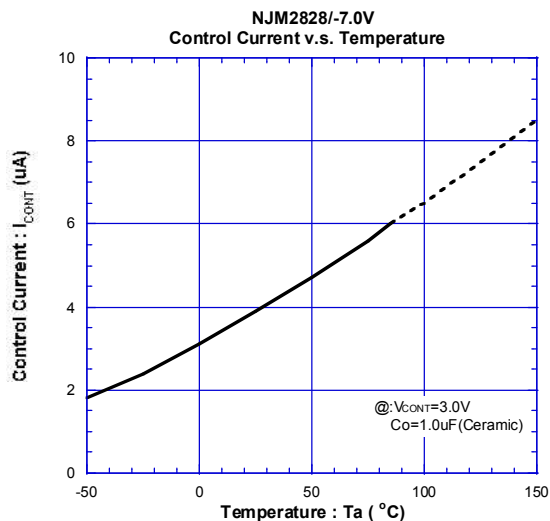
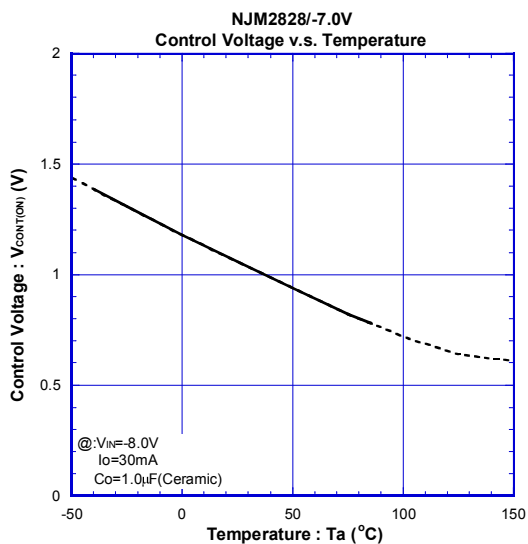
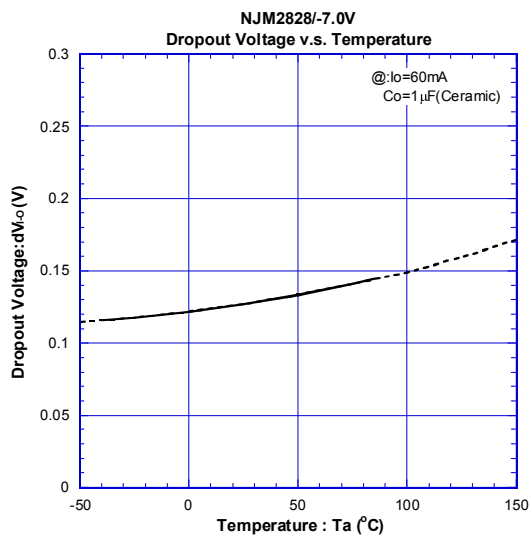
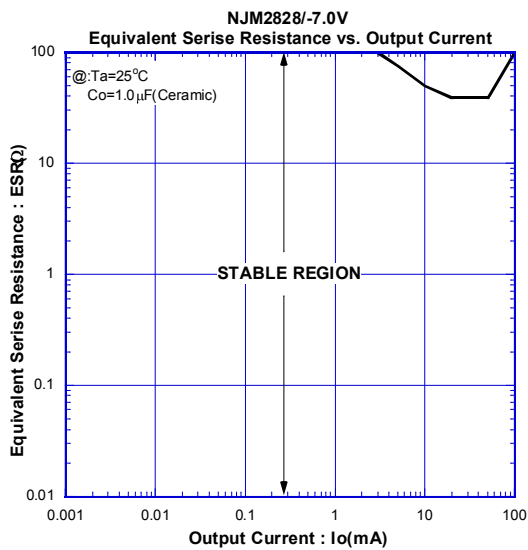

ELECTRICAL CHARACTERISTICS

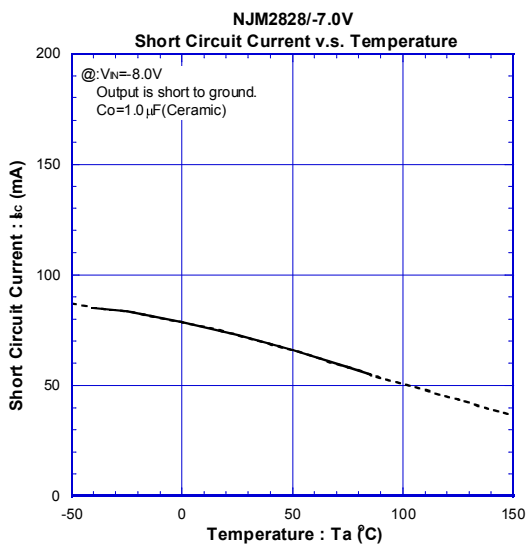
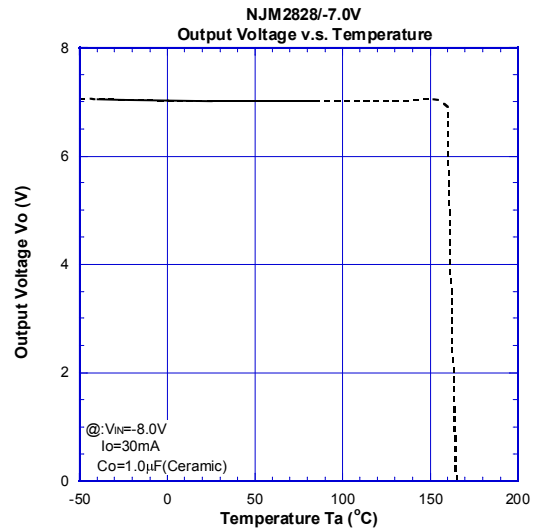
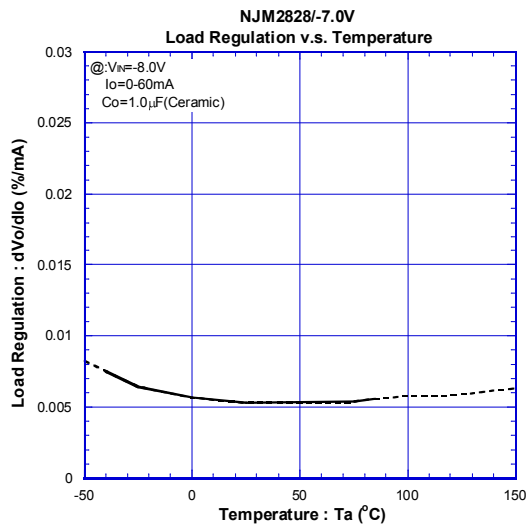
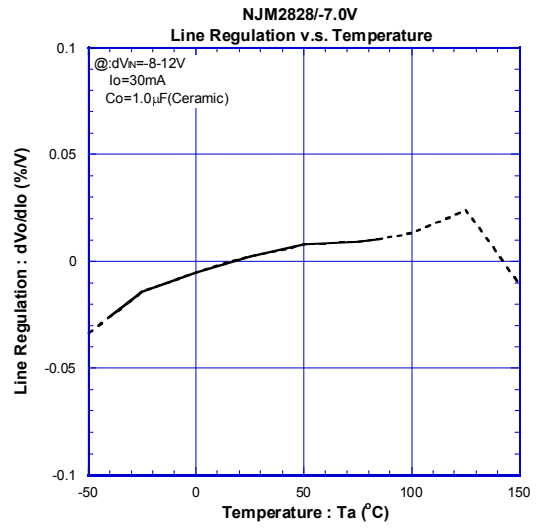
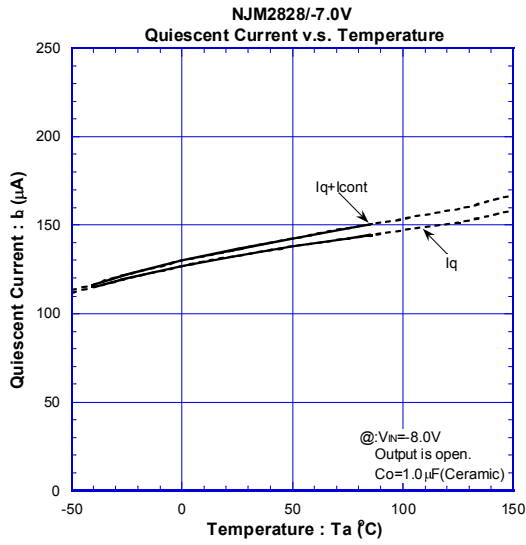

NJM2828

ELECTRICAL CHARACTERISTICS

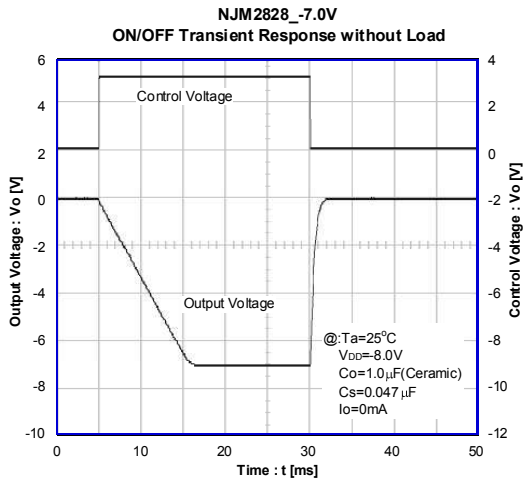
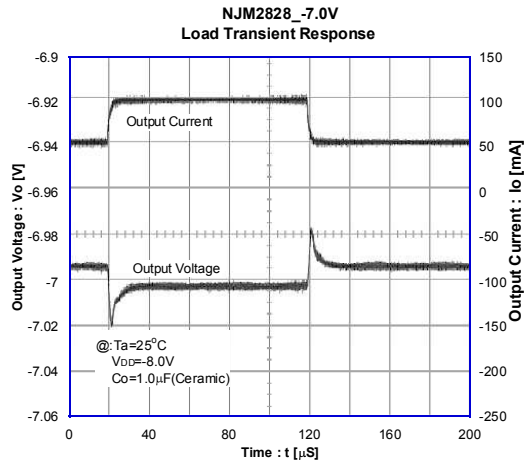
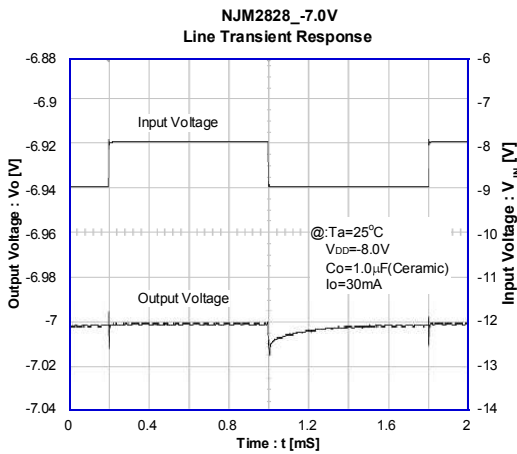

[CAUTION]
The specifications on this databook are only given for information, without any guarantee as regards either mistakes or omissions. The application circuits in this databook are described only to show representative usages of the product and not intended for the guarantee or permission of any right including the industrial rights.