

Low Dropout Voltage Regulator with Reset

■ GENERAL DISCRIPTION

The NJM2806 is a low dropout voltage regulator with reset function.

It provides up to 500mA of logic supply, and the reset function monitors input voltage of the regulator with 1% accuracy. It is suitable for local power supply and reset for small micro controller and other logic chips.

■ FEATURES

- Output Voltage Accuracy $V_o \pm 1.0\%$
- Reset Voltage Accuracy $V_{RT} \pm 1.0\%$
- Adjust reset delay time with external capacitor.
- Ripple Rejection 75dB typ. (f=1kHz)
- Input Voltage Monitor type
- Open Collector Output
- Internal Short Circuit Current Limit
- Internal Thermal Overload Protection
- Bipolar Technology
- Package Outline TO-252-5(DL3)

■ PACKAGE OUTLINE

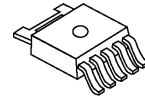

NJM2806DL3

■ PIN CONFIGURATION

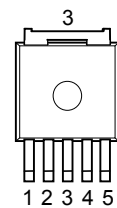

- 1. V_{OR}
- 2. V_{IN}
- 3. GND
- 4. V_{OUT}
- 5. Cd

NJM2806DL3

■ OUTPUT VOLTAGE/ DETECTION VOLTAGE

Device Name	Output Voltage	Detection Voltage
NJM2806DL3-2528	2.5V	2.8V
NJM2806DL3-3142	3.1V	4.2V
NJM2806DL3-3342	3.3V	4.2V

■ EQUIVALENT CIRCUIT

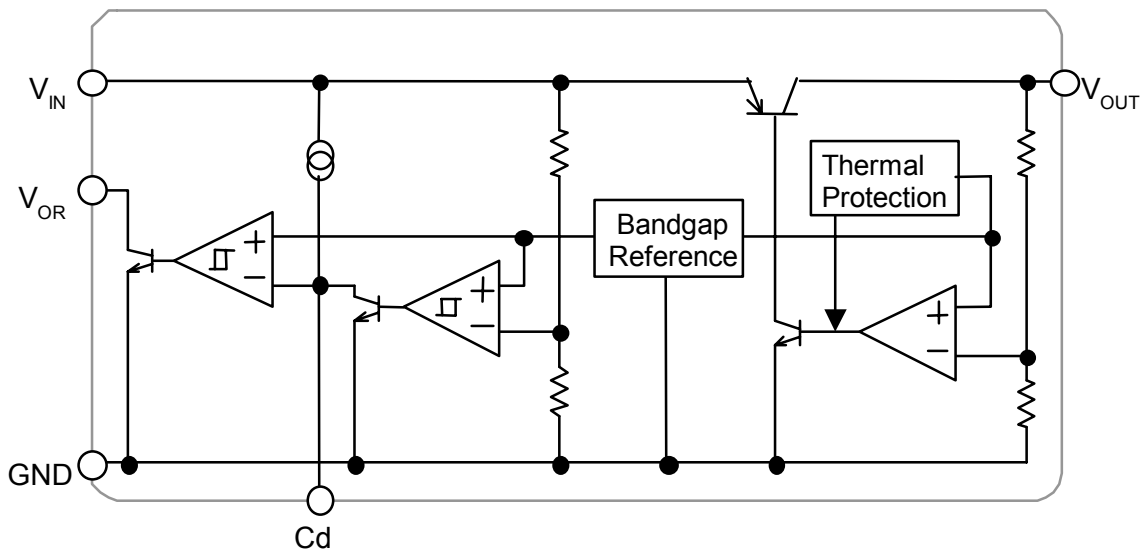

NJM2806

■ ABSOLUTE MAXIMUM RATINGS

(Ta=25°C)

PARAMETER	SYMBOL	RATINGS	UNIT
Input Voltage	V _{IN}	+14	V
Power Dissipation	P _D	8 (Tc=25°C)	W
		0.8(Ta≤25°C)	
Operating Temperature	Topr	-40 ~ +85	°C
Storage Temperature	Tstg	-40 ~ +125	°C

■ ELECTRICAL CHARACTERISTICS

(V_{IN}=V_o+1V, C_{IN}=0.33μF, C_o=1.0μF (C_o=2.2μF: V_o≤2.4V) Ta=25°C)

PARAMETER	SYMBOL	TEST CONDITION	MIN.	TYP.	MAX.	UNIT
Quiescent Current	I _Q	V _{IN} =V _o +2V, I _o =0mA	–	330	430	μA
Regulator Block						
Output Voltage	V _o	I _o =30mA	-1.0%	–	+1.0%	V
Output Current	I _o	V _o -0.3V	500	650	–	mA
Line Regulation	ΔV _o /ΔV _{IN}	V _{IN} =V _o +1V~V _o +6.0V, I _o =30mA	–	–	0.10	%/V
Load Regulation	ΔV _o /ΔI _o	I _o =0~500mA	–	–	0.03	%/mA
Dropout Voltage	ΔV _{I_O}	I _o =300mA	–	0.18	0.28	V
Ripple Rejection	RR	e _{in} =200mVrms, f=1kHz, I _o =10mA, V _o =3.0V Version	–	75	–	dB
Output Voltage Temperature Coefficient	ΔV _o /ΔT	Ta=0~85°C, I _o =10mA	–	±50	–	ppm/°C
Output Noise Voltage	V _{NO}	f=10Hz~80kHz, I _o =10mA, V _o =3.0V Version	–	45	–	μVrms
Reset Block						
Voltage Detection	V _{RT}	V _{IN} =H→L	-1.0%	–	+1.0%	V
Hysteresis Voltage	V _{RTH}	V _{IN} =H→L→H	V _{RT} ×3%	V _{RT} ×5%	V _{RT} ×8%	V
Low Level Output Voltage	R _{ORL}	V _{IN} =V _{RT} -0.5V, R _L =100kΩ	–	100	300	mV
Output Leak Current	I _{ORH}	V _{IN} =V _{RT} +0.5V	–	–	0.1	μA
On time Output Current	I _{ORL}	V _{IN} =V _{RT} -0.5V, R _L =0Ω	5	–	–	mA
Reset Output Delay Time	t _d	V _{IN} =(V _{RT} -0.5V)→(V _{RT} +0.5V), C _d =0.1μF	9	10	11	ms
Operation Voltage Limit	V _{OPL}	V _{ORL} =0.4V	–	0.9	–	V

The above specification is a common specification for all output voltages.

Therefore, it may be different from the individual specification for a specific output voltage.

■ TIMING CHART

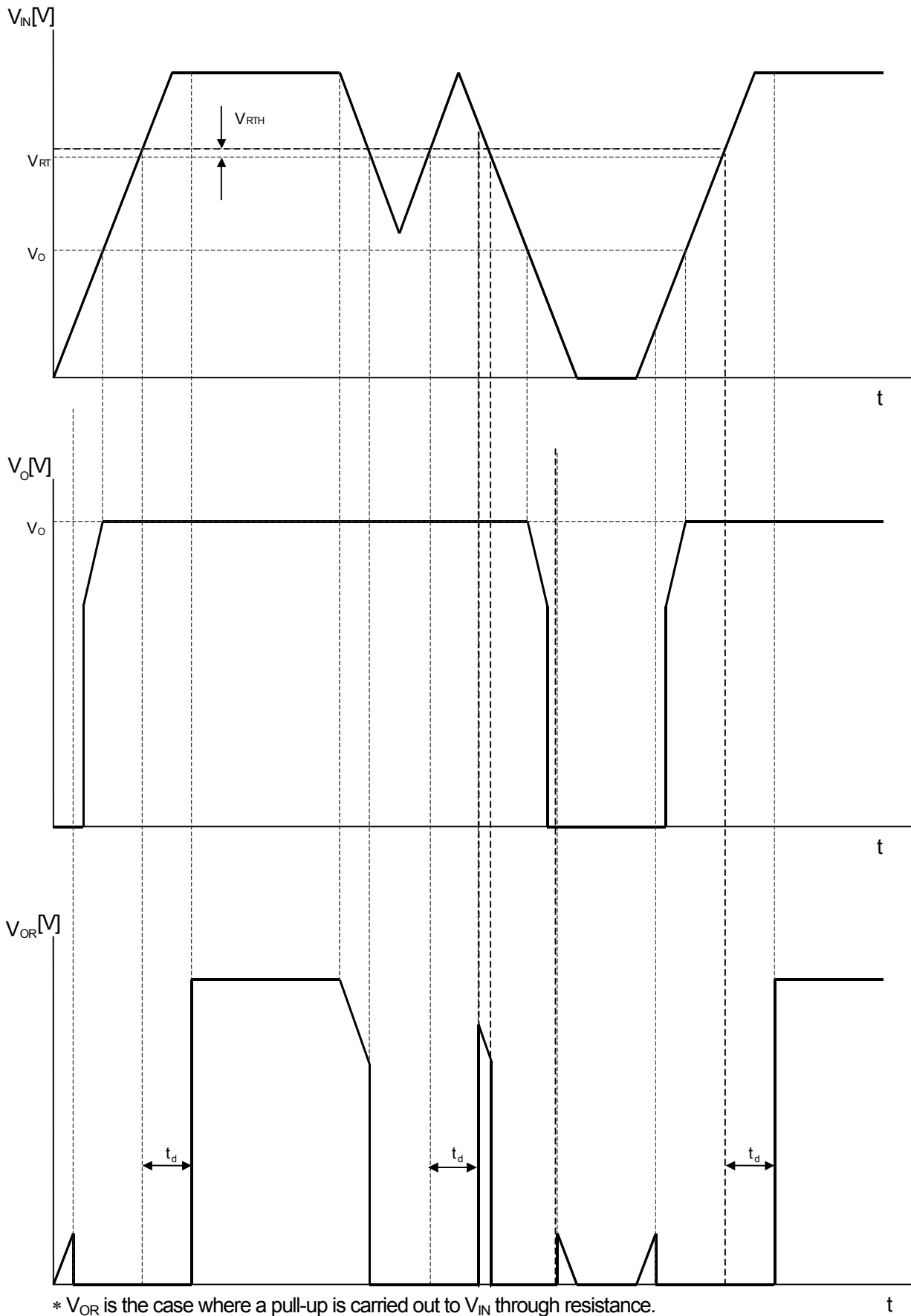

NJM2806

TEST CIRCUIT

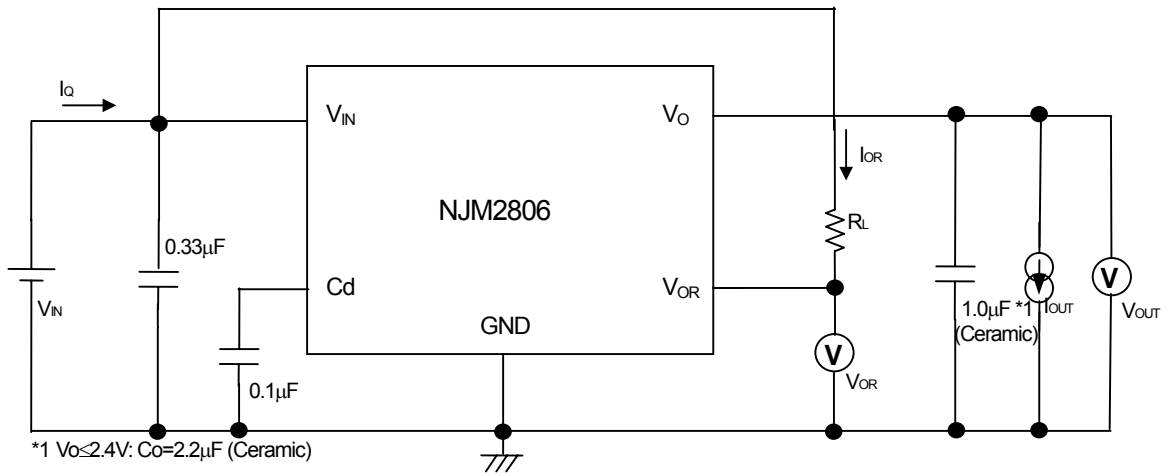

TYPICAL APPLICATIONS

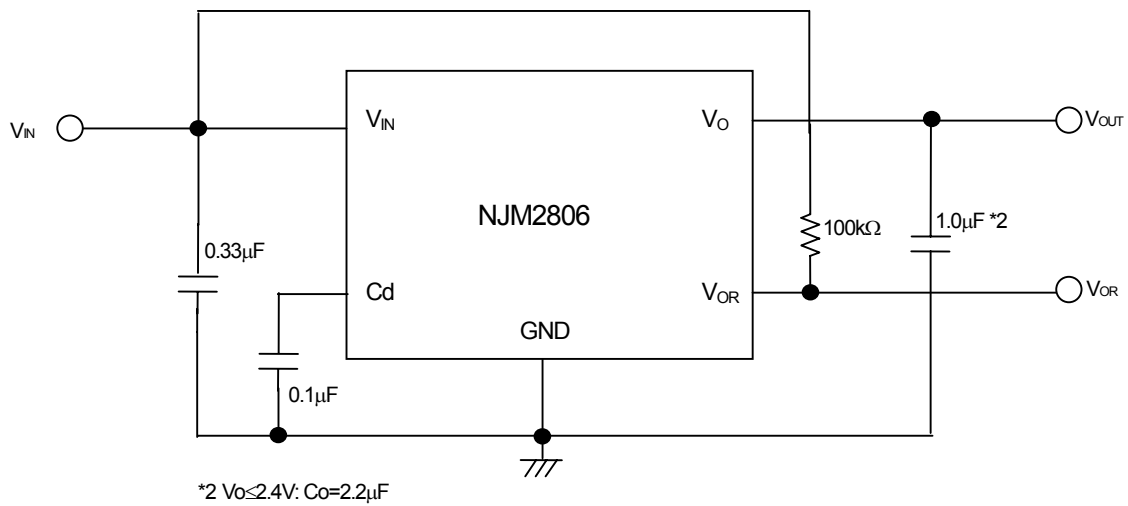

ELECTRICAL CHARACTERISTICS

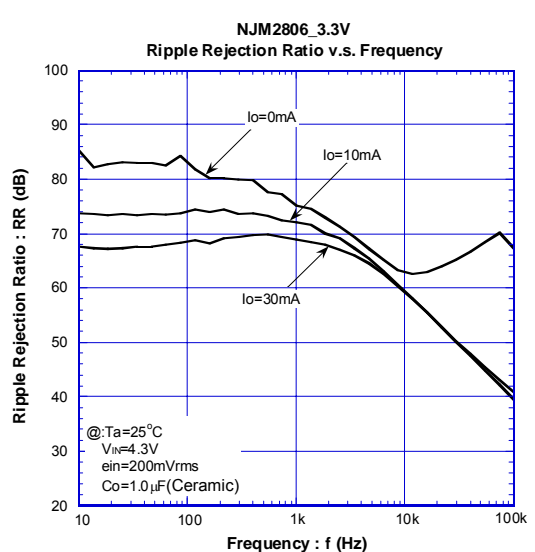
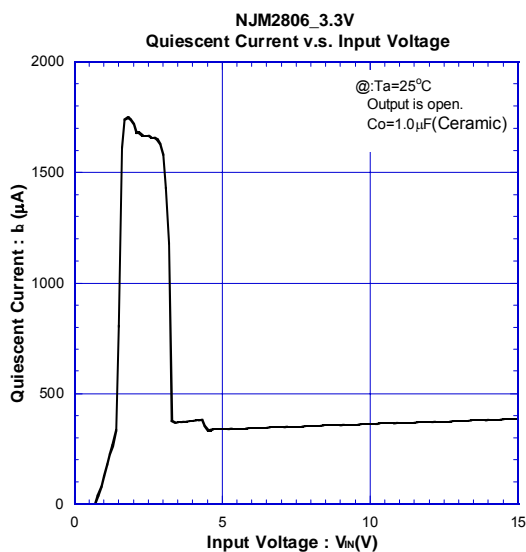
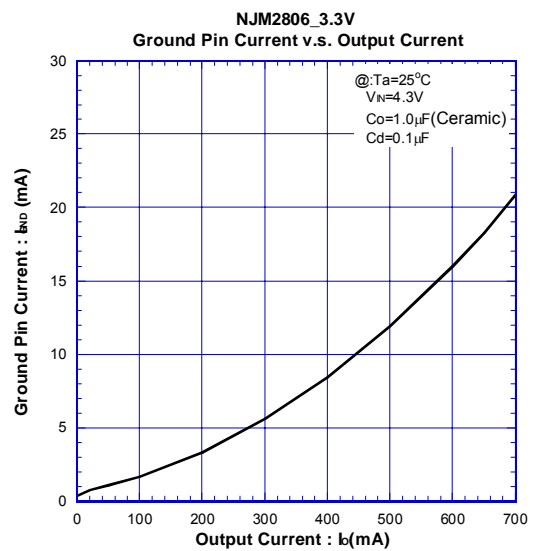
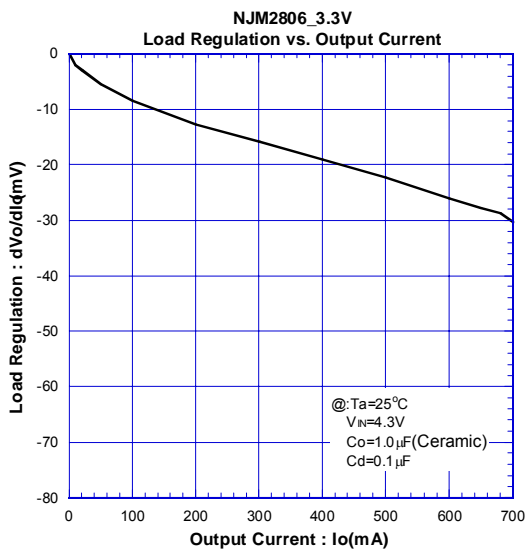
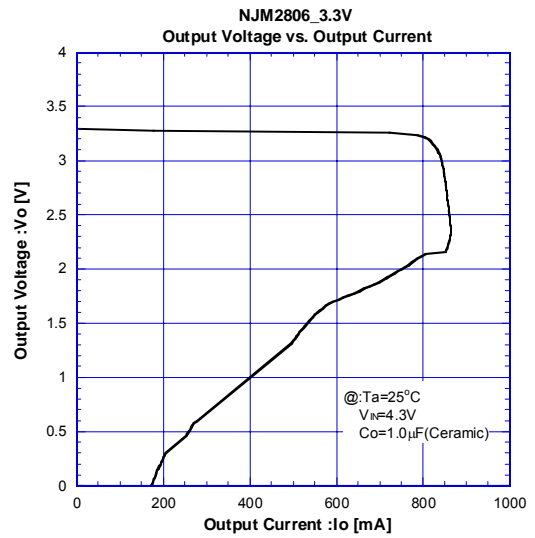
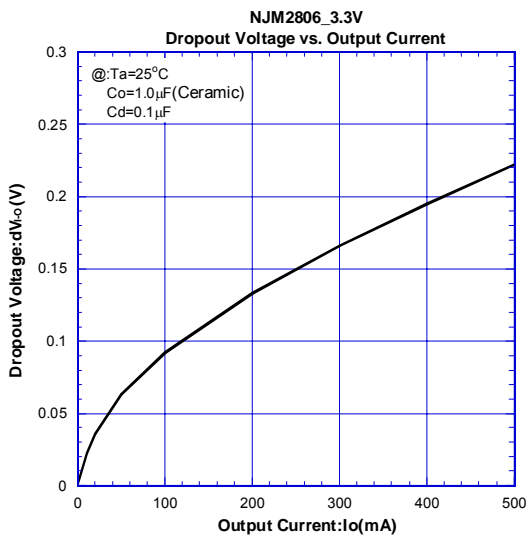

NJM2806

ELECTRICAL CHARISTICS

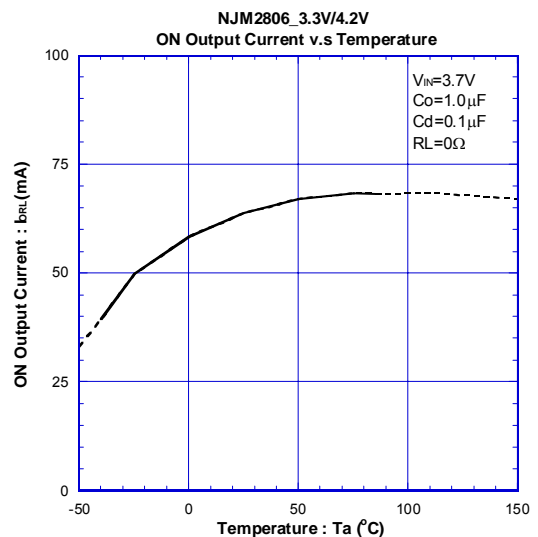
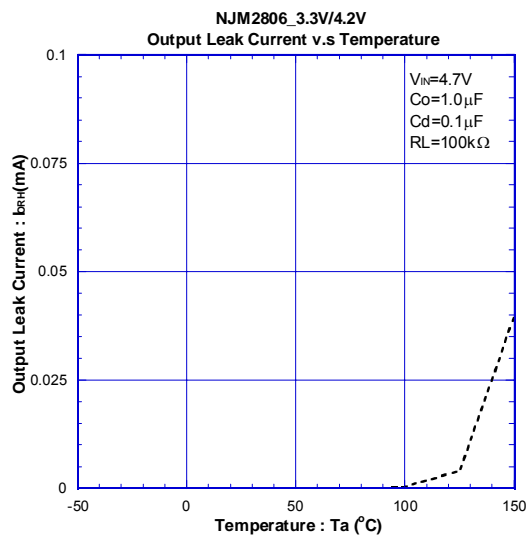
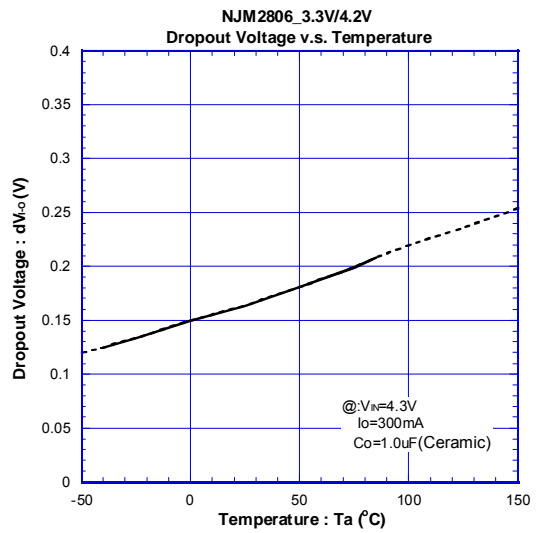
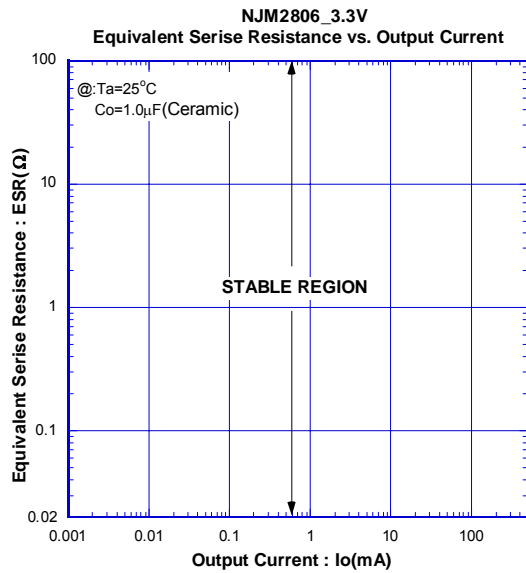
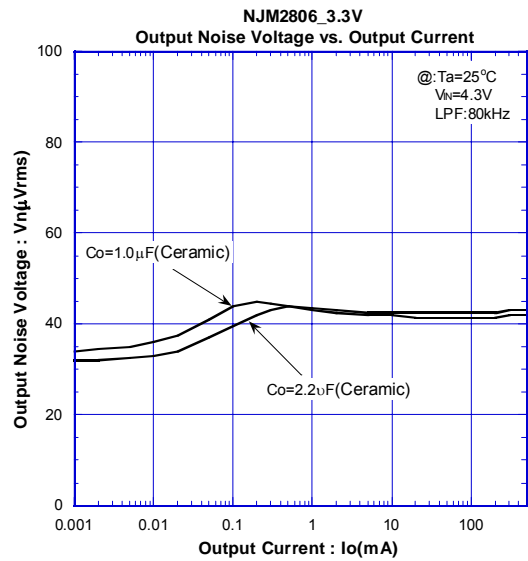
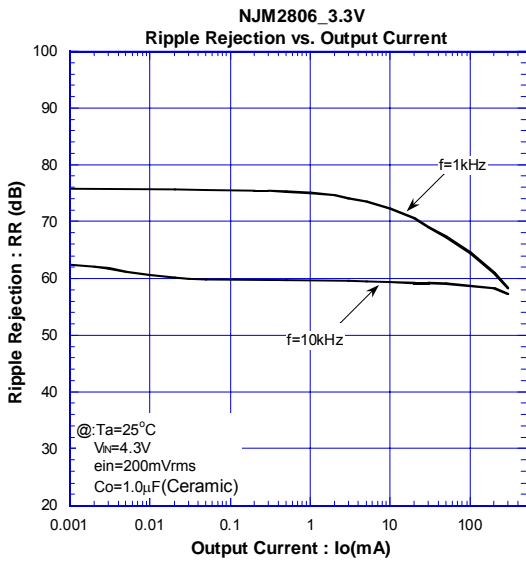

ELECTRICAL CHARACTERISTICS

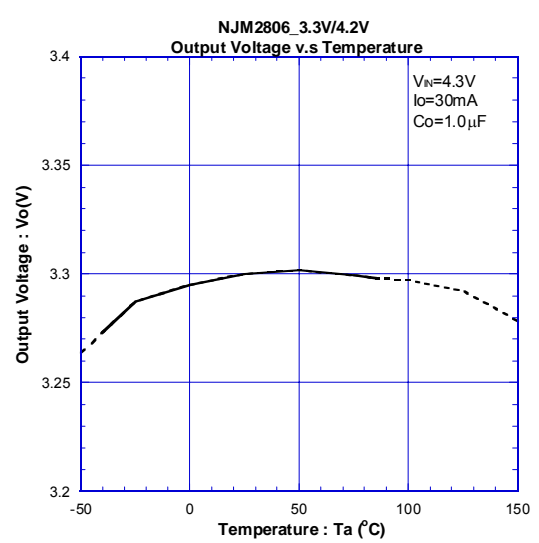
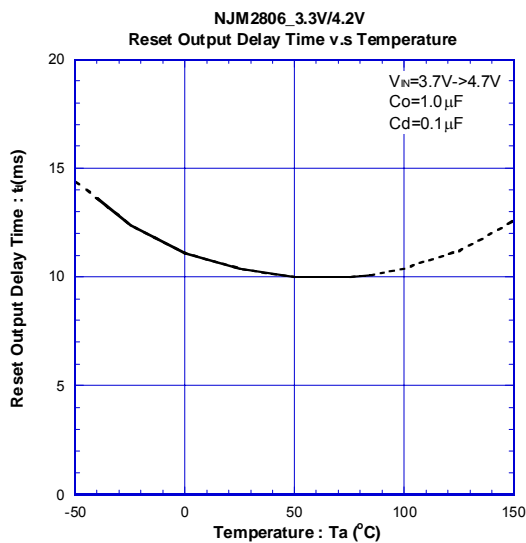
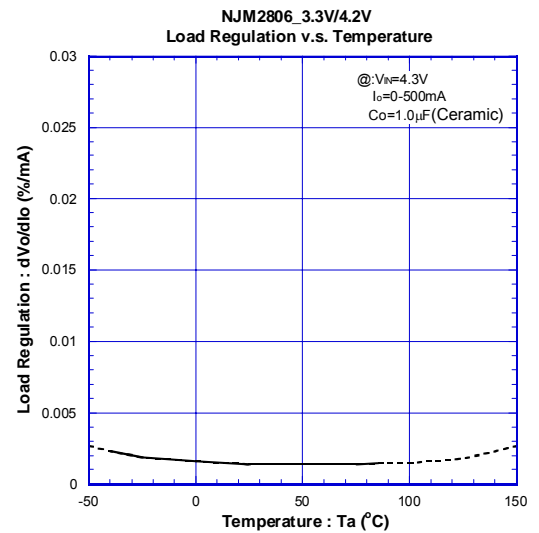
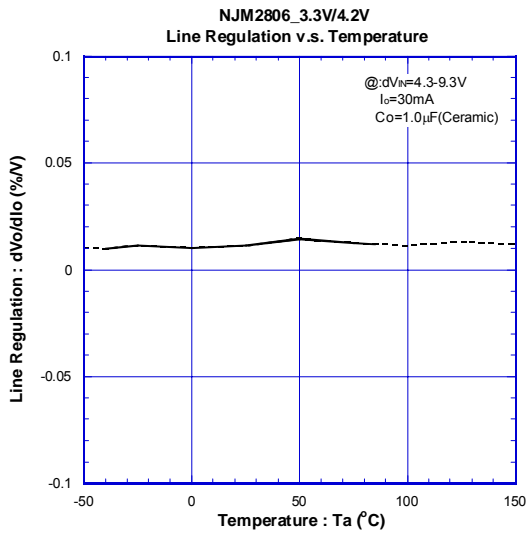
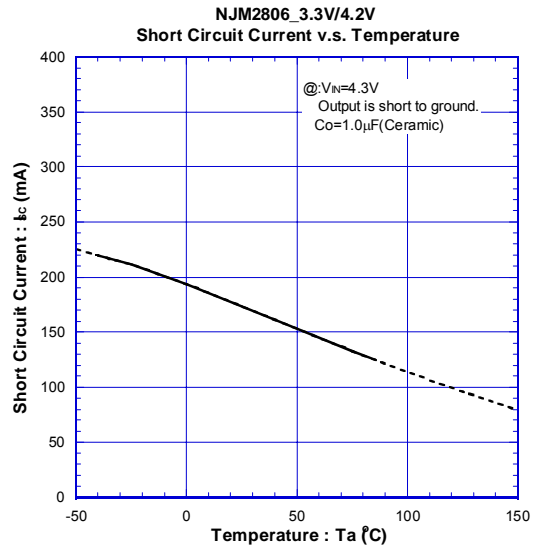
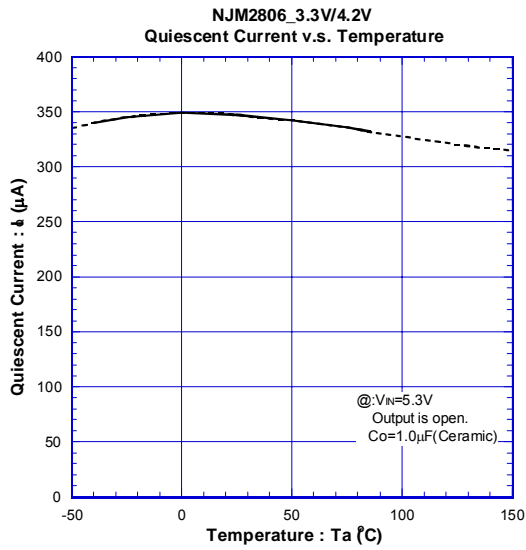

NJM2806

■ ELECTRICAL CHARISTICS

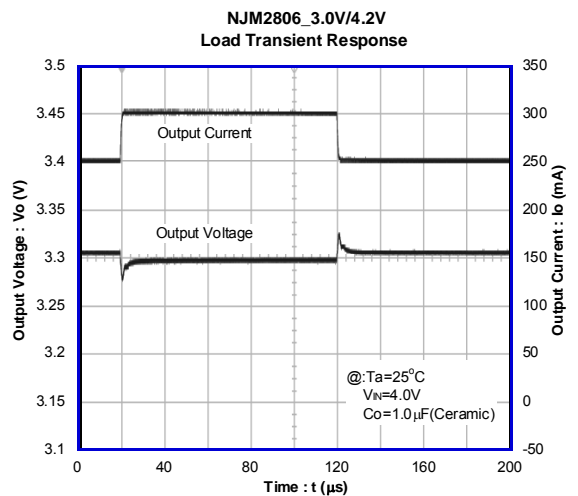
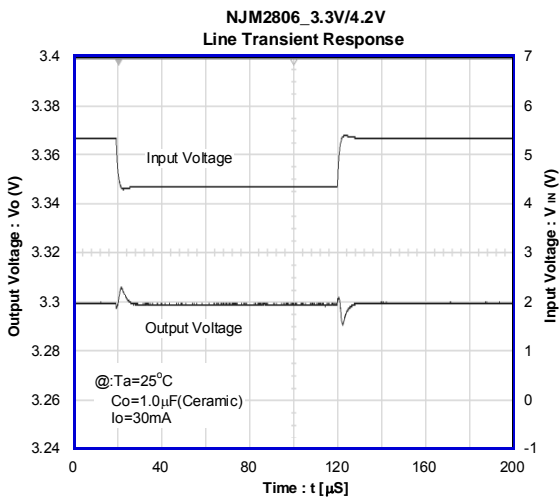
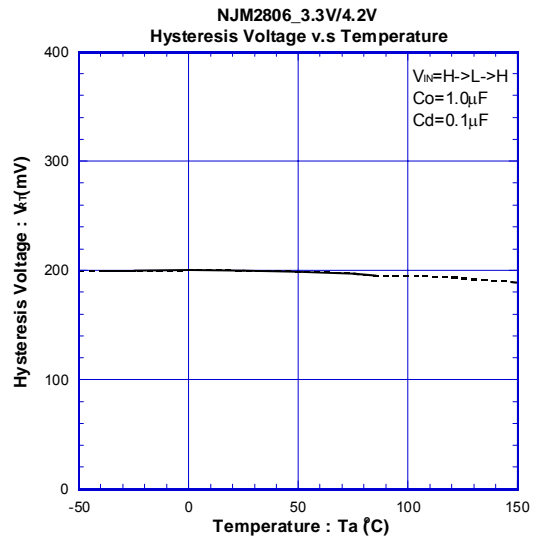
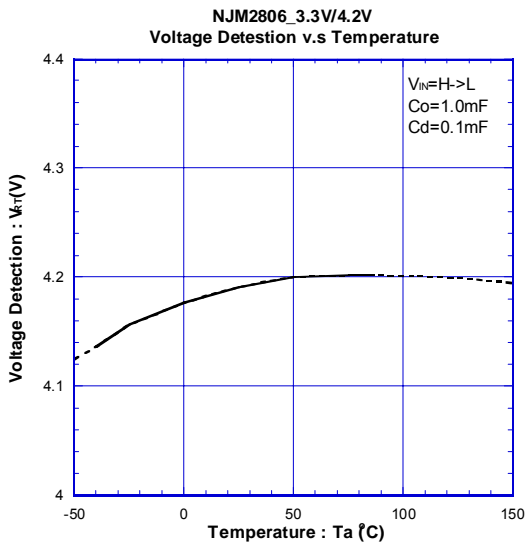
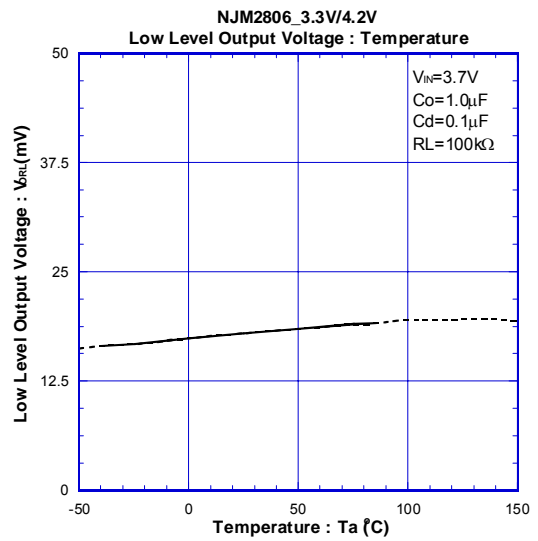
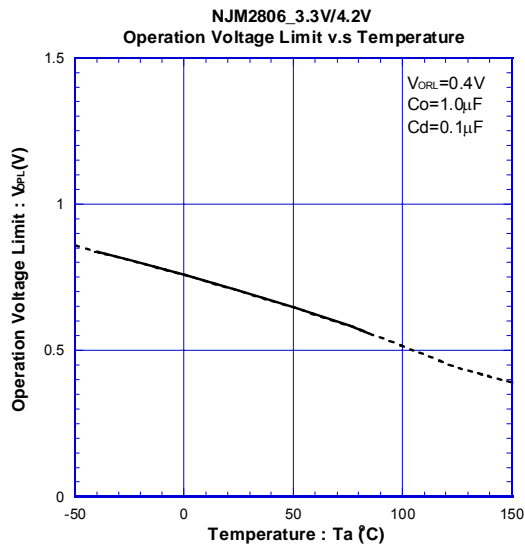

[CAUTION]

The specifications on this databook are only given for information, without any guarantee as regards either mistakes or omissions. The application circuits in this databook are described only to show representative usages of the product and not intended for the guarantee or permission of any right including the industrial rights.