

## Low Noise, High-Speed Dual Operational Amplifier

### ■ GENERAL DESCRIPTION

The NJM2719 is a high speed voltage feedback dual operational amplifier specifically optimized for low voltage noise.

Combining a voltage noise of  $2.5\text{nV}/\sqrt{\text{Hz}}$  typ. (at  $f=100\text{kHz}$ ) and unity gain of  $100\text{MHz}$ , the NJM2719 is ideal for I/Q baseband amplifier, RFID reader application and other wireless communication system designs.

The NJM2719 is available in two 8-lead package options: tiny fine pitch surface mount (SSOP/MSOP).

### ■ PACKAGE OUTLINE



NJM2719RB1  
(MSOP8(TVSP8))



NJM2719V  
(SSOP8)

### ■ FEATURES

- Low Noise
- Unity Gain Bandwidth
- Phase Margin
- Slew Rate
- Output Rail-to-Rail
- Operating Voltage
- Bipolar Technology
- Package Outline

$V_{ni} = 2.5\text{nV}/\sqrt{\text{Hz}}$  typ. (at  $f=100\text{kHz}$ )  
 $V_{ni} = 3\text{nV}/\sqrt{\text{Hz}}$  typ. (at  $f=10\text{kHz}$ )  
 $f_T = 100\text{MHz}$  typ. (at  $V^+/V^- = \pm 5\text{V}$ )  
 $f_T = 90\text{MHz}$  typ. (at  $V^+/V^- = \pm 2.5\text{V}$ )  
 $\Phi_m = 60\text{deg}$  typ.  
 $60\text{V}/\mu\text{s}$  typ. (at  $V^+/V^- = \pm 5\text{V}$ )  
 $35\text{V}/\mu\text{s}$  typ. (at  $V^+/V^- = \pm 2.5\text{V}$ )  
 $V_{OH} \geq +4.7\text{V}, V_{OL} \leq -4.8\text{V}$  (at  $V^+/V^- = \pm 5\text{V}$ )  
 $V_{OH} \geq +2.4\text{V}, V_{OL} \leq -2.4\text{V}$  (at  $V^+/V^- = \pm 2.5\text{V}$ )  
 $\pm 2.25\text{V} \sim \pm 5\text{V}$

NJM2719V : SSOP8  
 NJM2719RB1 : MSOP8 (TVSP8) MEET JEDEC MO-187-DA/ THIN TYPE

### ■ APPLICATION

- Wireless Communication Equipment
- I/Q Baseband Application
- RFID Reader Application
- Active Filter
- ADC/DAC Buffer
- Ultrasound Amplifier

### ■ PIN CONFIGURATION

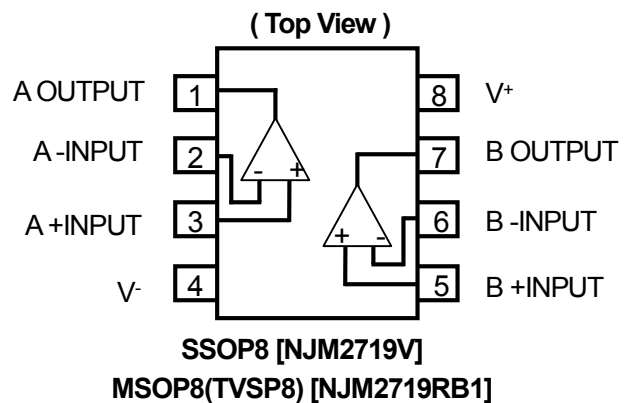

# NJM2719

## ■ ABSOLUTE MAXIMUM RATINGS (Ta=25°C)

PARAMETER	SYMBOL	RATINGS	UNIT
Supply Voltage	V <sup>+</sup>	±5.5	V
Common Mode Input Voltage Range	V <sub>ICM</sub>	±5.5 (Note1)	V
Differential Input Voltage Range	V <sub>ID</sub>	±3	V
Power Dissipation	P <sub>D</sub>	310[SSOP8], 400[MSOP8(TVSP8)]	mW
		410[SSOP8](Note2), 510[MSOP8(TVSP8)] (Note2)	mW
Operating Temperature Range	T <sub>opr</sub>	-40 to +85	°C
Storage Temperature Range	T <sub>stg</sub>	-50 to +150	°C

(Note 1) The output voltage of normal operation will be the Output Voltage Swing of electrical characteristics.

(Note 2) On the PCB " EIA/JEDEC (114.3x76.2x1.57mm, two layers, FR-4) "

(Note 3) Do not exceed "Power dissipation: PD" in which power dissipation in IC is shown by the absolute maximum rating.  
Refer to following Figure 1 for a permissible loss when ambient temperature (Ta) is Ta ≥25°C.

Figure1: Power Dissipation – Ambient Temperature

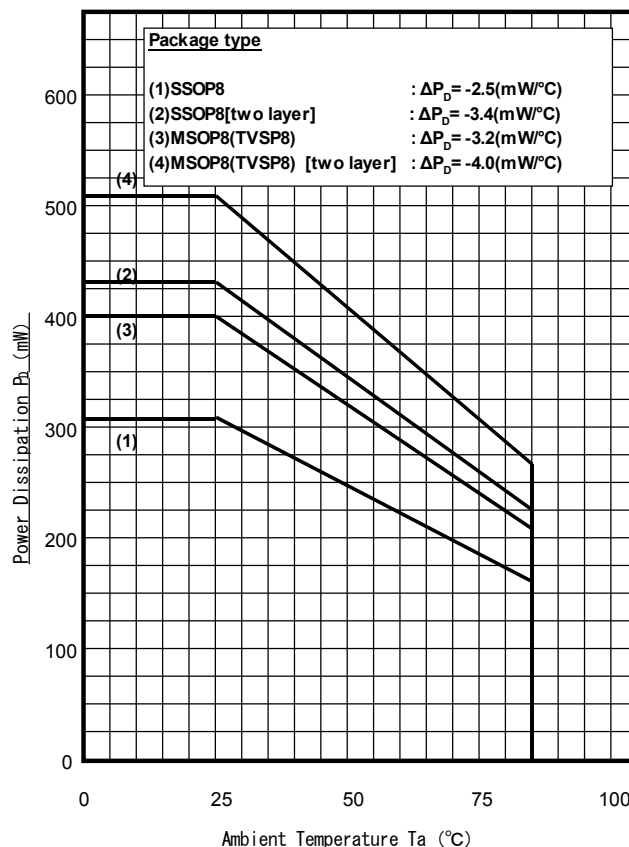

## ■ OPERATING VOLTAGE (Ta=25°C)

PARAMETER	SYMBOL	TEST CONDITION	MIN.	TYP.	MAX.	UNIT
Supply Voltage	V <sup>+</sup> /V <sup>-</sup>	(Note3)	±2.25	-	±5.5	V

## ■ ELECTRICAL CHARACTERISTICS

### ●DC CHARACTERISTICS (V<sup>+</sup>/V<sup>-</sup>=±2.5V, Ta=25°C)

PARAMETER	SYMBOL	TEST CONDITION	MIN.	TYP.	MAX.	UNIT
Supply Current	I <sub>CC</sub>	No Signal	-	11	14	mA
Input Offset Voltage	V <sub>IO</sub>	Rs=50Ω	-	1	9	mV
Input Offset Voltage Drift	ΔV <sub>IO</sub> /ΔT	Rs=50Ω	-	10	-	μV/deg
Input Bias Current	I <sub>B</sub>		-	2.9	25	μA
Input Offset Current	I <sub>IO</sub>		-	0.2	2	μA
Voltage Gain	A <sub>V</sub>	R <sub>L</sub> = 1kΩ to 0V, V <sub>O</sub> = ±1V	68	91	-	dB
Common Mode Rejection Ratio	CMR	-2V ≤ V <sub>CM</sub> ≤ +1.2V	82	92	-	dB
Supply Voltage Rejection Ratio	SVR	±2.25V ≤ V <sup>+</sup> /V <sup>-</sup> ≤ ±5V	84	97	-	dB
Maximum Output Voltage 1	V <sub>OH1</sub>	R <sub>L</sub> = 1kΩ to 0V	+2.3	+2.4	-	V
	V <sub>OL1</sub>		-	-2.4	-2.3	
Maximum Output Voltage 2	V <sub>OH2</sub>	I <sub>source</sub> =4mA, +Input =+0.1V, -Input =-0.1V	+2.2	+2.3	-	V
	V <sub>OL2</sub>	I <sub>sink</sub> =4mA, +Input =-0.1V, -Input =+0.1V	-	-2.3	-2.2	
Common Mode Input Voltage Range	V <sub>ICM+</sub>	CMR≥82dB	+1.2	-	-	V
	V <sub>ICM-</sub>		-	-	-2	

### ●AC CHARACTERISTICS (V<sup>+</sup>/V<sup>-</sup>=±2.5V, Ta=25°C)

PARAMETER	SYMBOL	TEST CONDITION	MIN.	TYP.	MAX.	UNIT
Unity Gain	f <sub>T</sub>	A <sub>V</sub> =+40dB,	-	90	-	MHz
Phase Margin	φ <sub>m</sub>	R <sub>f</sub> =1.98kΩ, R <sub>g</sub> =20Ω,	-	60	-	deg
Gain Margin	G <sub>m</sub>	R <sub>L</sub> =1kΩ to 0V, C <sub>L</sub> =5pF	-	10	-	dB
Equivalent Input Noise Voltage	V <sub>NI1</sub>	f=100kHz	-	2.5	-	nV/√Hz
	V <sub>NI2</sub>	f=10kHz	-	3	-	
Equivalent Input Noise Current	I <sub>NI</sub>	f=100kHz	-	3	-	pA/√Hz
Channel Separation	CS	f=1MHz, V <sub>in</sub> =0.2Vpp, A <sub>V</sub> =+1, R <sub>L</sub> =1kΩ to 0V, C <sub>L</sub> =5pF	-	70	-	dB

### ●TRANSIENT CHARACTERISTICS (V<sup>+</sup>/V<sup>-</sup>=±2.5V, Ta=25°C)

PARAMETER	SYMBOL	TEST CONDITION	MIN.	TYP.	MAX.	UNIT
Slew Rate 1	+SR1	A <sub>V</sub> =0dB, R <sub>L</sub> =1kΩ to 0V, C <sub>L</sub> =5pF, V <sub>out</sub> =2Vpp	-	35	-	V/μs
	-SR1		-	35	-	
Slew Rate 2	+SR2	A <sub>V</sub> =+6dB, R <sub>L</sub> =1kΩ to 0V, C <sub>L</sub> =5pF, V <sub>out</sub> =2Vpp	-	30	-	V/μs
	-SR2		-	30	-	
Rise Time	t <sub>r</sub>	A <sub>V</sub> =+6dB, R <sub>L</sub> =1kΩ to 0V, C <sub>L</sub> =5pF, V <sub>out</sub> =0.2Vpp, 10% to 90%	-	8.3	-	ns
Fall Time	t <sub>f</sub>		-	8.3	-	ns
Power Band Width	PBW	A <sub>V</sub> =+6dB, R <sub>L</sub> =1kΩ to 0V, C <sub>L</sub> =5pF, V <sub>out</sub> =2Vpp, HD2 ≤40dB, HD3 ≤40dB	-	3	-	MHz
Total Harmonic Distortion	THD	A <sub>V</sub> =+6dB, R <sub>L</sub> =1kΩ to 0V, C <sub>L</sub> =5pF, f=10kHz, V <sub>out</sub> =2Vpp	-	0.1	-	%
Second Harmonic	HD2	A <sub>V</sub> =+6dB, R <sub>L</sub> =1kΩ to 0V, C <sub>L</sub> =5pF, f=1MHz, V <sub>out</sub> =2Vpp	-	-50	-	dBc
Third Harmonic	HD3		-	-50	-	dBc
Settling time (1%)	ts1	A <sub>V</sub> =+6dB, R <sub>L</sub> =1kΩ to 0V, C <sub>L</sub> =5pF, V <sub>out</sub> =2Vpp	-	100	-	ns
Settling time (0.1%)	ts2		-	110	-	ns

# NJM2719

## ●DC CHARACTERISTICS ( $V^+V^- = \pm 5V$ , $T_a = 25^\circ C$ )

PARAMETER	SYMBOL	TEST CONDITION	MIN.	TYP.	MAX.	UNIT
Supply Current	$I_{CC}$	No Signal	-	14	17	mA
Input Offset Voltage	$V_{IO}$	$R_s = 50\Omega$	-	1	9	mV
Input Offset Voltage Drift	$\Delta V_{IO}/\Delta T$	$R_s = 50\Omega$	-	10	-	$\mu V/deg$
Input Bias Current	$I_B$		-	2.9	25	$\mu A$
Input Offset Current	$I_{IO}$		-	0.2	2	$\mu A$
Voltage Gain	$A_v$	$R_L = 1k\Omega$ to 0V, $V_o = \pm 1V$	70	91	-	dB
Common Mode Rejection Ratio	CMR	$-4.5V \leq V_{CM} \leq +3.7V$	82	92	-	dB
Supply Voltage Rejection Ratio	SVR	$\pm 2.25V \leq V^+V^- \leq \pm 5V$	84	97	-	dB
Maximum Output Voltage 1	$V_{OH1}$	$R_L = 1k\Omega$ to 0V	+4.6	+4.7	-	V
	$V_{OL1}$		-	-4.8	-4.7	
Maximum Output Voltage 2	$V_{OH2}$	Isource =5mA, +Input =+0.1V, -Input =-0.1V	+4.5	+4.6	-	V
	$V_{OL2}$		Isink =5mA, +Input =-0.1V, -Input =+0.1V	-	-4.7	-4.6
Common Mode Input Voltage Range	$V_{ICM+}$	CMR $\geq 82$ dB	+3.7	-	-	V
	$V_{ICM-}$		-	-	-4.5	

## ●AC CHARACTERISTICS ( $V^+V^- = \pm 5V$ , $T_a = 25^\circ C$ )

PARAMETER	SYMBOL	TEST CONDITION	MIN.	TYP.	MAX.	UNIT
Unity Gain	fT	$A_v = +40$ dB,	-	100	-	MHz
Phase Margin	$\phi_m$	$R_f = 1.98k\Omega$ , $R_g = 20\Omega$ ,	-	60	-	deg
Gain Margin	Gm	$R_L = 1k\Omega$ to 0V, $C_L = 5pF$	-	10	-	dB
Equivalent Input Noise Voltage	$V_{NI1}$	f = 100kHz	-	2.5	-	nV/ $\sqrt{Hz}$
	$V_{NI2}$	f = 10kHz	-	3	-	
Equivalent Input Noise Current	$I_{NI}$	f = 100kHz	-	3	-	pA/ $\sqrt{Hz}$
Channel Separation	CS	f = 1MHz, $V_{in} = 0.2V_{pp}$ , $A_v = +1$ , $R_L = 1k\Omega$ to 0V, $C_L = 5pF$	-	70	-	dB

## ●TRANSIENT CHARACTERISTICS ( $V^+V^- = \pm 5V$ , $T_a = 25^\circ C$ )

PARAMETER	SYMBOL	TEST CONDITION	MIN.	TYP.	MAX.	UNIT
Slew Rate 1	+SR1	$A_v = 0$ dB, $R_L = 1k\Omega$ to 0V, $C_L = 5pF$ , $V_{out} = 5V_{pp}$	-	60	-	V/ $\mu s$
	-SR1		-	60	-	
Slew Rate 2	+SR2	$A_v = +6$ dB, $R_L = 1k\Omega$ to 0V, $C_L = 5pF$ , $V_{out} = 5V_{pp}$	-	55	-	V/ $\mu s$
	-SR2		-	55	-	
Rise Time	$t_r$	$A_v = +6$ dB, $R_L = 1k\Omega$ to 0V, $C_L = 5pF$ , $V_{out} = 0.2V_{pp}$ , 10% to 90%	-	8	-	ns
Fall Time	$t_f$		-	8	-	
Power Band Width	PBW	$A_v = +6$ dB, $R_L = 1k\Omega$ to 0V, $C_L = 5pF$ , $V_{out} = 2V_{pp}$ , HD2 $\leq 40$ dB, HD3 $\leq 40$ dB	-	4	-	MHz
Total Harmonic Distortion	THD	$A_v = +6$ dB, $R_L = 1k\Omega$ to 0V, $C_L = 5pF$ , f = 10kHz, $V_{out} = 2V_{pp}$	-	0.1	-	%
Second Harmonic	HD2	$A_v = +6$ dB, $R_L = 1k\Omega$ to 0V, $C_L = 5pF$ , f = 1MHz, $V_{out} = 2V_{pp}$	-	-50	-	dBc
Third Harmonic	HD3		-	-50	-	
Settling time (1%)	$t_{s1}$	$A_v = +6$ dB, $R_L = 1k\Omega$ to 0V, $C_L = 5pF$ , $V_{out} = 2V_{pp}$	-	90	-	ns
Settling time (0.1%)	$t_{s2}$		-	110	-	

## TYPICAL CHARACTERISTICS

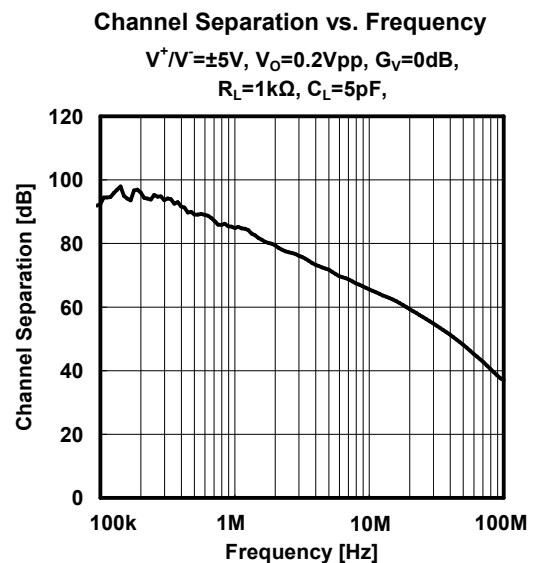
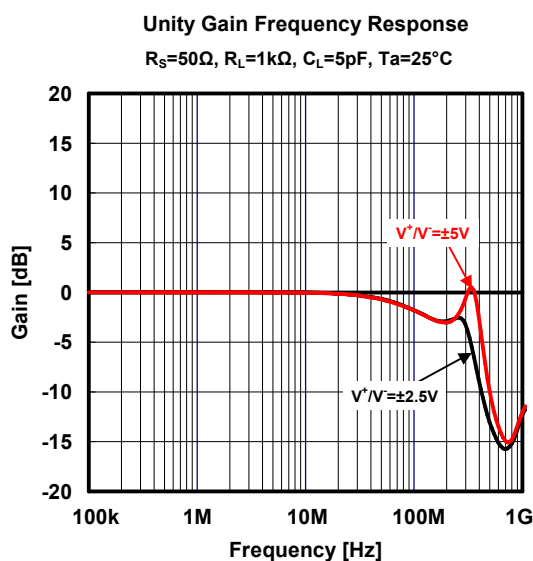
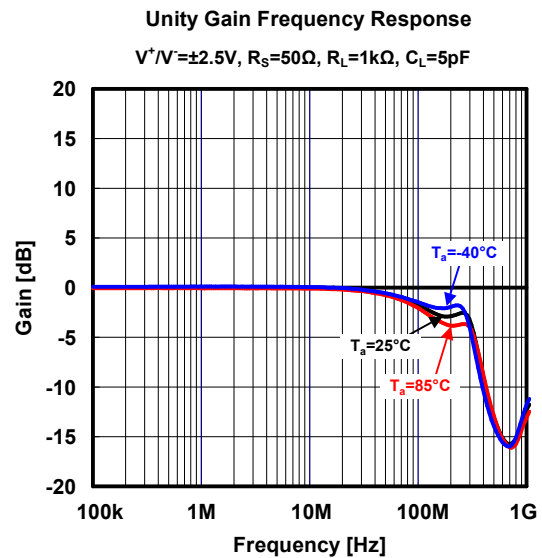
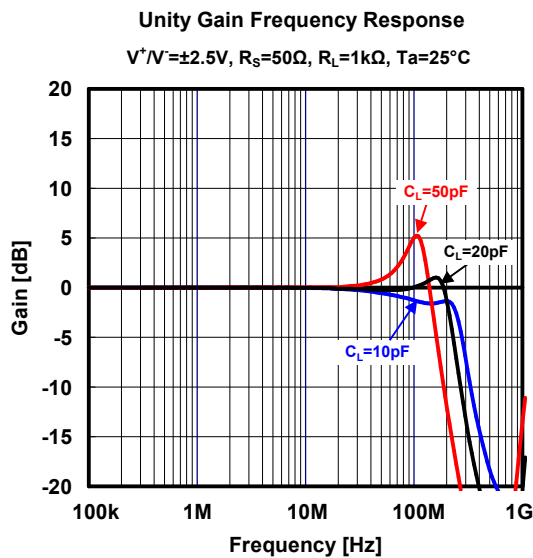
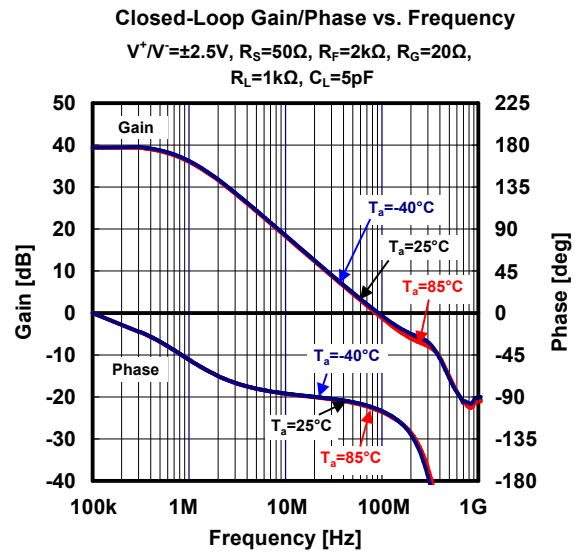
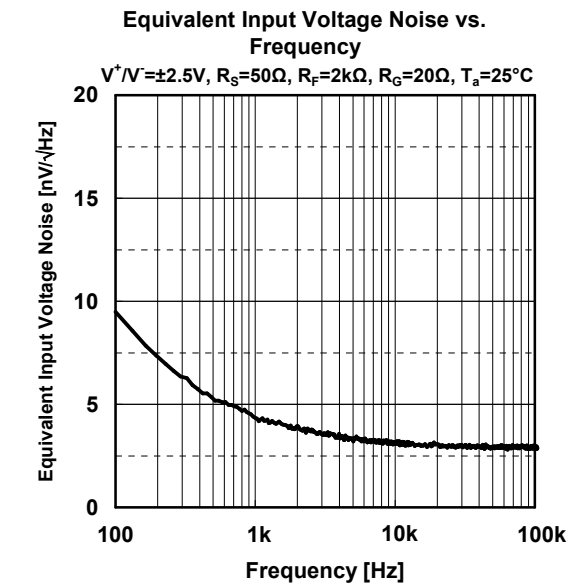

### Transient Response

$V^+/V^- = \pm 2.5V, f = 4MHz, V_O = 2V_{PP}, G_V = 1, R_T = 50\Omega,$   
 $R_L = 1k\Omega, T_a = 25^\circ C$

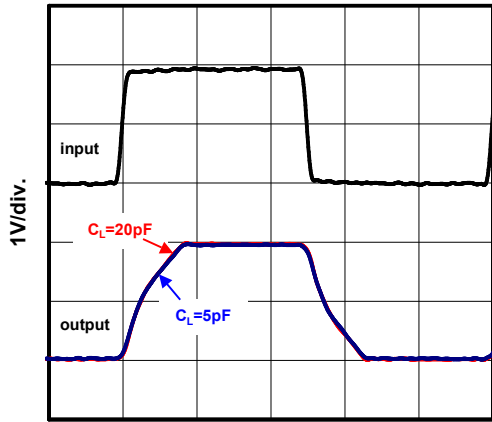

50ns/div

### Transient Response

$V^+/V^- = \pm 5V, f = 4MHz, V_O = 5V_{PP}, G_V = 1, R_T = 50\Omega,$   
 $R_L = 1k\Omega, T_a = 25^\circ C$

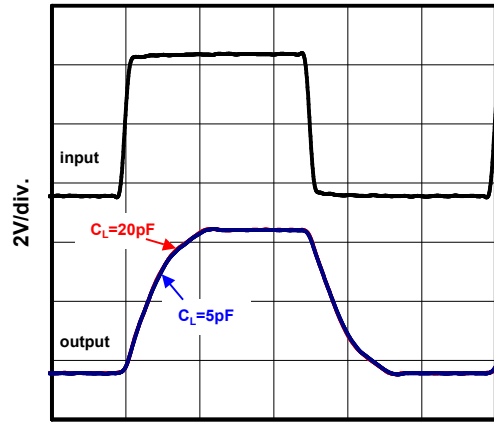

50ns/div

### Transient Response

$V^+/V^- = \pm 2.5V, f = 4MHz, V_O = 2V_{PP}, G_V = 1, R_T = 50\Omega,$   
 $R_L = 1k\Omega, C_L = 5pF$

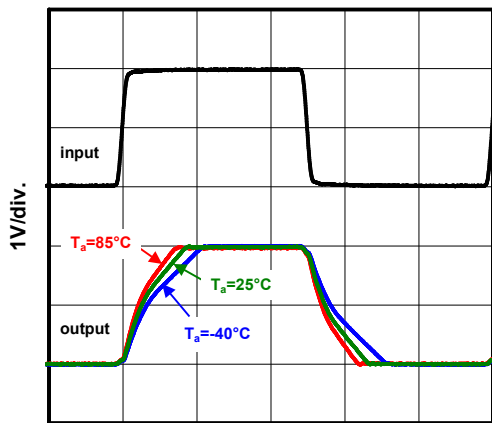

50ns/div

### Transient Response

$V^+/V^- = \pm 5V, f = 4MHz, V_O = 5V_{PP}, G_V = 1, R_T = 50\Omega,$   
 $R_L = 1k\Omega, C_L = 5pF$

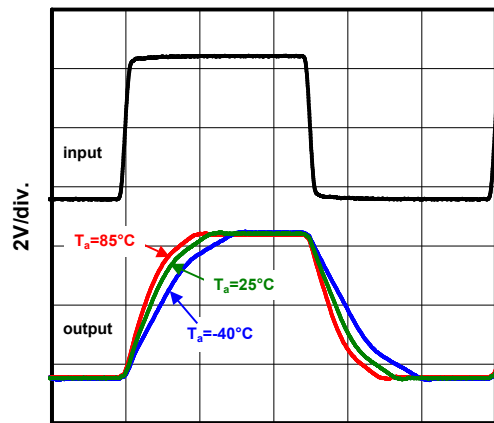

50ns/div

### Supply Current vs. Supply Voltage

$G_V = 0dB, T_a = 25^\circ C$

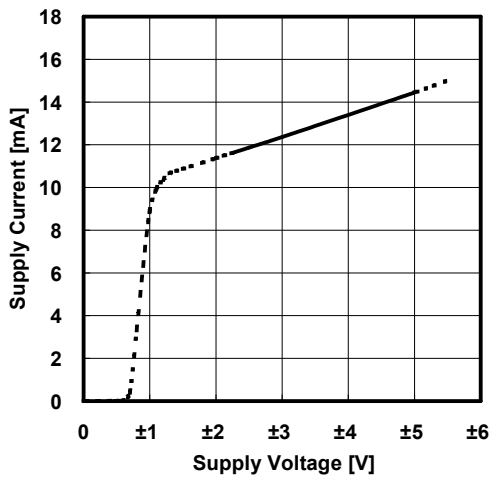

### Supply Current vs. Temperature

$G_V = 0dB, V_{CM} = 0V$

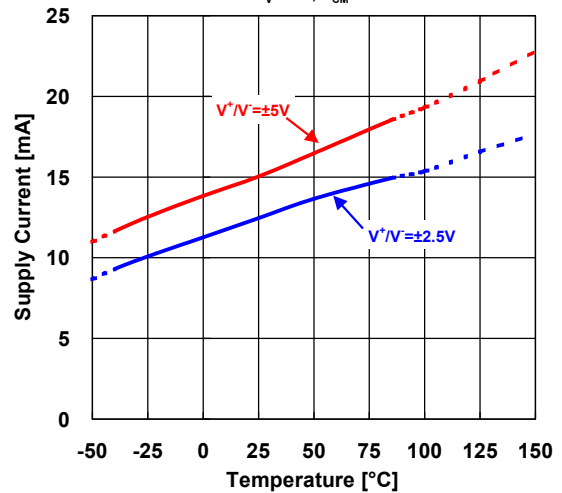

**Maximum Output Voltage vs. Load Resistance**  
 $V^+/V^- = \pm 2.5V, V_{IN} = \pm 0.2V$

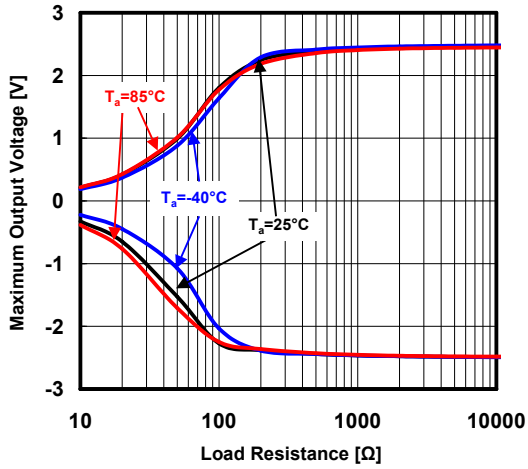

**Maximum Output Voltage vs. Supply Voltage**  
 $V_{IN} = \pm 0.2V, R_L = 1k\Omega$

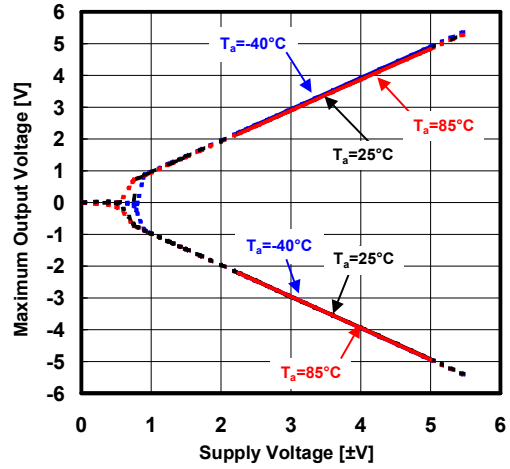

**Maximum Output Voltage vs. Output Current**  
 $V^+/V^- = \pm 2.5V, V_{IN} = \pm 0.2V$

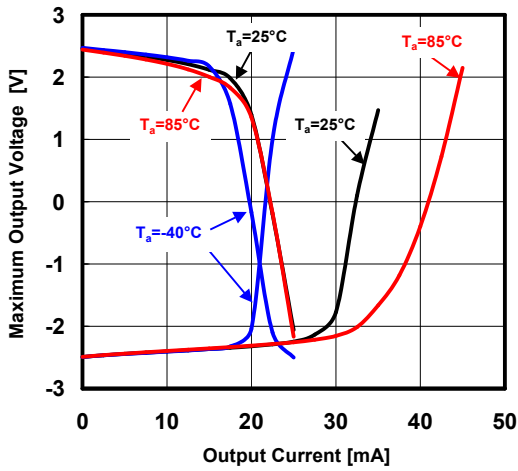

**Maximum Output Voltage vs. Output Current**  
 $V^+/V^- = \pm 2.5V, V_{IN} = \pm 0.2V$

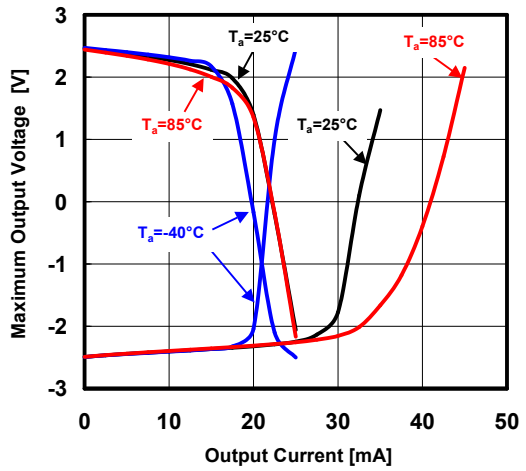

**Input Offset Voltage vs. Temperature**  
 $V_{CM} = 0V$

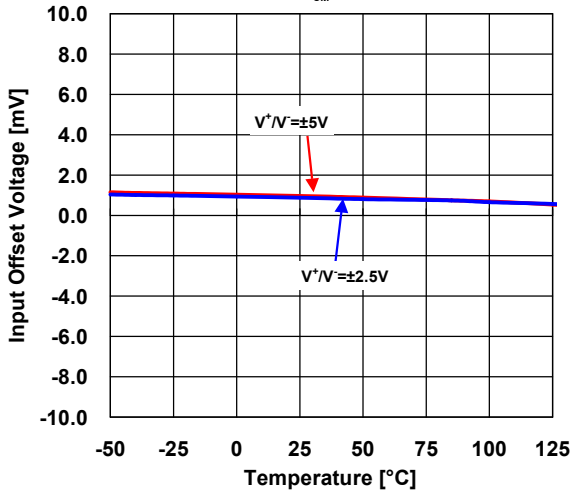

**Input Offset Voltage vs. Input Common-mode Voltage**  
 $V^+/V^- = \pm 2.5V$

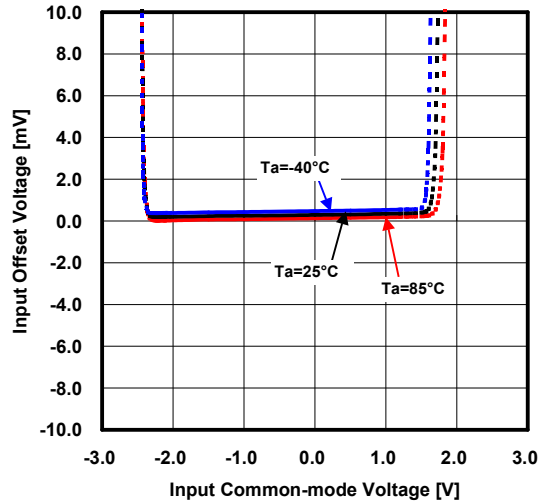

**Open-loop Voltage Gain vs. Temperature**  
 $V_{OUT} = -1V$  to  $+1V$ ,  $R_L = 1k\Omega$

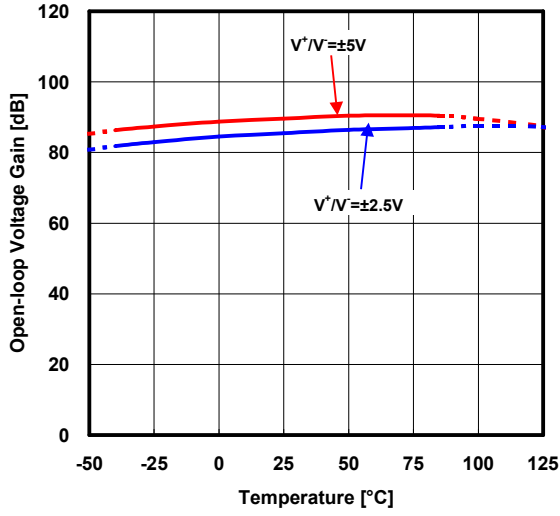

**Supply Voltage Rejection Ratio vs. Temperature**

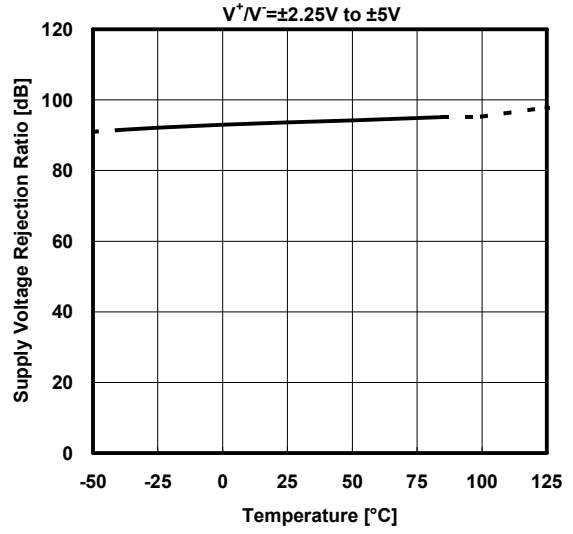

**Common-mode Rejection Ratio vs. Temperature**

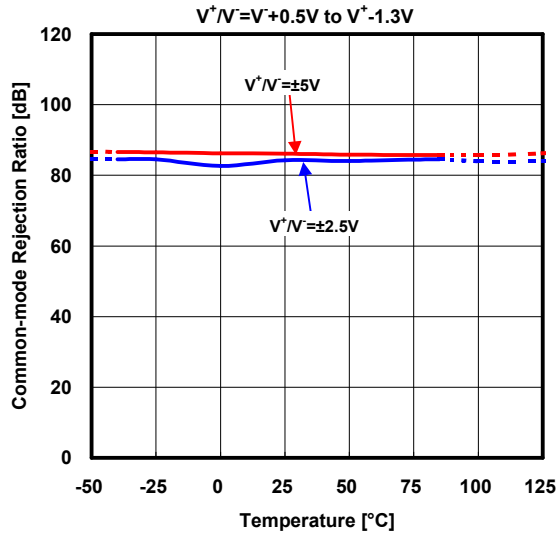

**Input Offset Current vs. Temperature**  
 $V_{CM} = 0V$

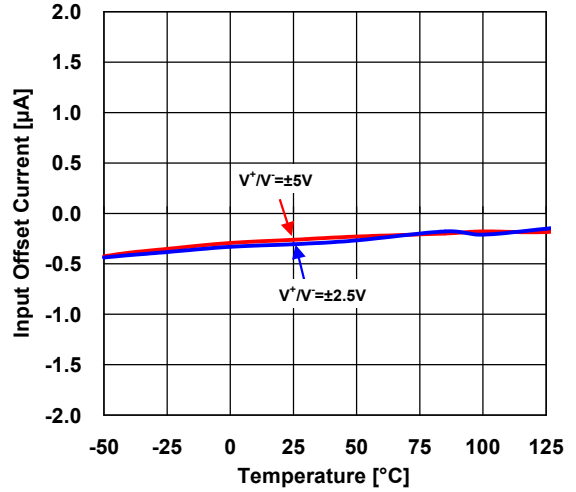



## ■ APPLICATION

### ● Stability

Generally, when driving a large capacitive load in low closed-loop gain or unity-gain configurations, circuit stability is reduced. In the case of using the NJM2719 for these configurations, it is necessary to care about unwanted oscillation.

An effective way to improve stability and to avoid oscillation is to add an isolation resistor as shown in Figure 1.

Figure 2 shows required resistor values ( $R_{ISO}$ ) for stability versus load capacitances ( $C_L$ ) in the unity-gain configuration (Figure 1). To ensure the stability, add a larger isolation resistor in Figure 2. (Resistor values in Figure 2 are reference values when parasitic capacitance of an evaluation board is minimized.)

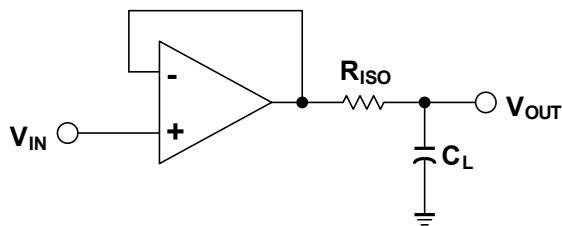

Figure 1.

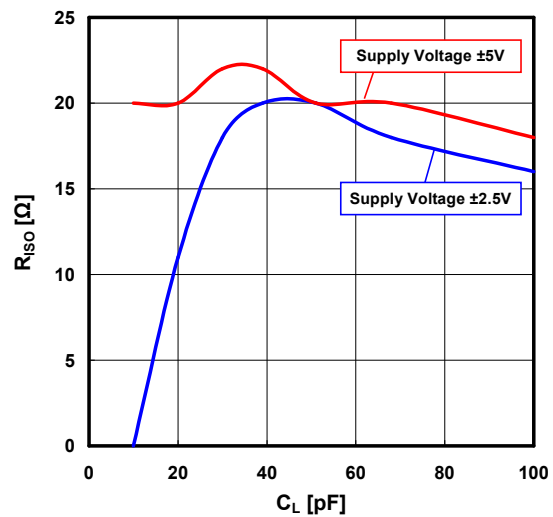

Figure 2. Required Isolation Resistor values for stability,  $R_{ISO}$ [ $\Omega$ ], versus Capacitive Loads,  $C_L$ [pF]. ( $G_V=0dB$ )

## ■ NOTE

[CAUTION]

The specifications on this data book are only given for information, without any guarantee as regards either mistakes or omissions. The application circuits in this data book are described only to show representative usages of the product and not intended for the guarantee or permission of any right including the industrial rights.