

Single-Supply High-Operating voltage Dual Operational Amplifier

■ GENERAL DESCRIPTION

The NJM2718 is a single-supply high-operating voltage dual operational amplifier. It is suitable for high supply voltage applications.

Large-capacitance drive capability is better or equal than competing products.

■ PACKAGE OUTLINE



NJM2718E
(SOP8)



NJM2718V
(SSOP8)

■ FEATURES

- Single Supply
- Operating Voltage 3V~36V
- Input Offset Voltage 4mV max.
- Large Capacitance Drive Capability 1000pF typ.
- Output Voltage $V_{OH} \geq +13.5V, V_{OL} \leq -14.0V$ (at $V^+ / V^- = \pm 15V, R_L = 2k\Omega$)
 $V_{OH} \geq +3.7V, V_{OL} \leq 0.3V$ (at $V^+ = +5V, R_L = 2k\Omega$)
- Slew Rate 3.5V/ μ s typ. (at $V_{in} = 1V_{pp}, R_L = 2k\Omega$)
9V/ μ s typ. (at $V_{in} = 20V_{pp}, R_L = 2k\Omega$)
- Bipolar Technology
- Package Outline SOP8 JEDEC 150mil , SSOP8

■ APPLICATION

- Low-Side Current Sense
- PWM Motor Control System
- Power Supply Module
- Line Driver, ADC/DAC Buffer

■ PIN CONFIGURATION

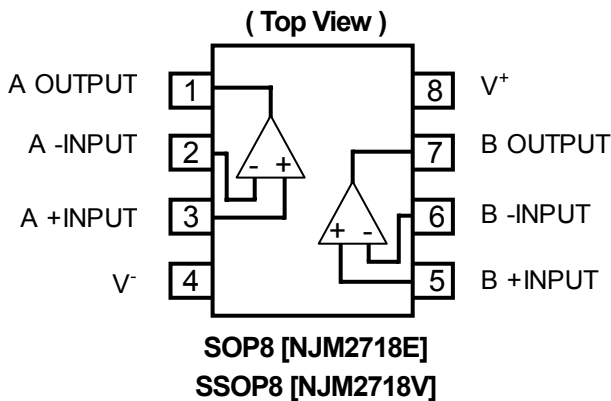

NJM2718

■ ABSOLUTE MAXIMUM RATINGS

(Ta=25°C)

PARAMETER	SYMBOL	RATINGS	UNIT
Supply Voltage	V ⁺	+40	V
Common Mode Input Voltage Range	V _{ICM}	V ⁻ -0.3V to V ⁺ +0.3V	V
Differential Input Voltage Range	V _{ID}	±40	V
Output Voltage	V _O	V ⁻ -0.3V to V ⁺ +0.3V (Note1)	V
Output Sink/Source Current for Each one Output Terminal	I _{OPORT}	±80 (Note3)	mA
Flow in Current for V ⁺ terminal	I _{V+}	90 (Note3)	mA
Flow out Current for V ⁻ terminal	I _{Ov-}	90 (Note3)	mA
Power Dissipation	P _D	300 [SOP8], 250[SSOP8]	mW
		500[SOP8] (Note2)	mW
		350[SSOP8] (Note2)	mW
Operating Temperature Range	T _{opr}	-40 to +85	°C
Storage Temperature Range	T _{stg}	-50 to +125	°C

(Note 1) The output voltage of normal operation will be the Output Voltage Swing of electrical characteristics.

(Note 2) On the PCB " EIA/JEDEC (76.2x114.3x1.6mm, two layers, FR-4) "

(Note 3) Do not exceed "Power dissipation: PD" in which power dissipation in IC is shown by the absolute maximum rating.
Refer to following Figure 1 for a permissible loss when ambient temperature (Ta) is Ta≥25°C.

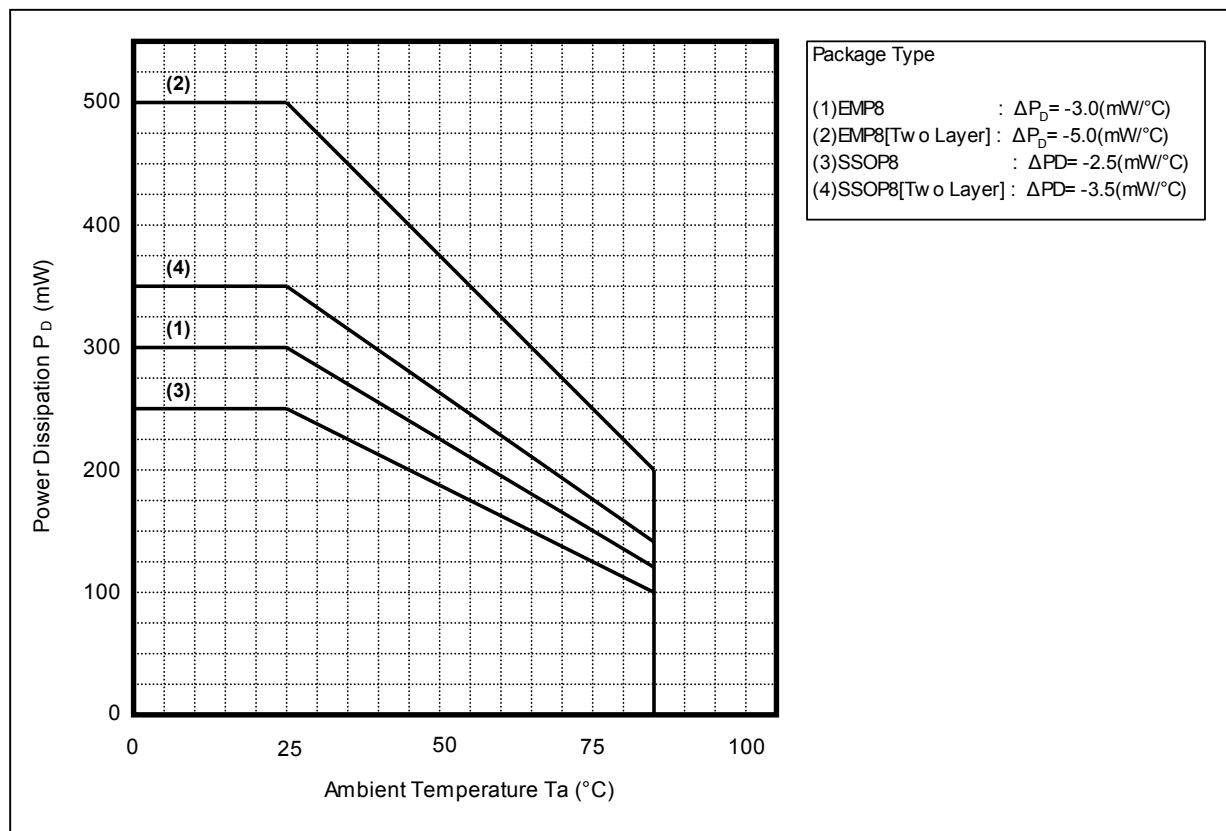

Figure1: Power Dissipation – Ambient Temperature

■ OPERATING VOLTAGE

(Ta=25°C)

PARAMETER	SYMBOL	TEST CONDITION	MIN.	TYP.	MAX.	UNIT
Supply Voltage	V ⁺	(Note3)	+3	-	+36	V

■ ELECTRICAL CHARACTERISTICS

●DC CHARACTERISTICS ($V^+V^- = \pm 15V$, $T_a = 25^\circ C$)

PARAMETER	SYMBOL	TEST CONDITION	MIN.	TYP.	MAX.	UNIT
Supply Current	I_{CC}	No Signal	-	3.7	5.3	mA
Input Offset Voltage	V_{IO}	$R_s = 50\Omega$	-	1	4	mV
Input Offset Voltage Drift	$\Delta V_{IO}/\Delta T$	$R_s = 50\Omega$	-	10	-	$\mu V/deg$
Input Bias Current	I_B	$R_s = 50\Omega$	-	1.2	4	μA
Input Offset Current	I_{IO}	$R_s = 50\Omega$	-	0.1	1.8	μA
Voltage Gain	A_v	$R_L \geq 2k\Omega$, $V_o = \pm 10V$, $R_s = 50\Omega$	88	100	-	dB
Common Mode Rejection Ratio	CMR	$-15V \leq V_{ICM} \leq +13V$, $R_s = 50\Omega$	70	83	-	dB
Supply Voltage Rejection Ratio	SVR	$\pm 1.5V \leq V^+V^- \leq \pm 18V$, $R_s = 50\Omega$	70	100	-	dB
Maximum Output Voltage 1	V_{OH1}	$R_L = 10k\Omega$ to 0V	+13.7	+14	-	V
	V_{OL1}	$R_L = 10k\Omega$ to 0V	-	-14.6	-14.2	V
Maximum Output Voltage 2	V_{OH2}	$R_L = 2k\Omega$ to 0V	+13.5	+14.0	-	V
	V_{OL2}	$R_L = 2k\Omega$ to 0V	-	-13.9	-13.5	V
Output Source Current	I_{source}	$V_{in+} = +1V$, $V_{in-} = 0V$, $V_o = 0V$	10	30	-	mA
Output Sink Current	I_{sink}	$V_{in+} = 0V$, $V_{in-} = +1V$, $V_o = 0V$	20	30	-	mA
Common Mode Input Voltage	V_{ICM}	CMR ≥ 70 dB	-15	-	+13	V

●AC CHARACTERISTICS ($V^+V^- = \pm 15V$, $T_a = 25^\circ C$)

PARAMETER	SYMBOL	TEST CONDITION	MIN.	TYP.	MAX.	UNIT
Gain Bandwidth Product	GBW	$f = 100kHz$	-	1.8	-	MHz
Power Band1	PBW1	$G_v = +1$, $R_L = 2k\Omega$ to 0V, $V_o = 20V_{pp}$, THD=1%	-	80	-	kHz
Power Band2	PBW2	$G_v = +1$, $R_L = 2k\Omega$ to 0V, $V_o = 2V_{pp}$, THD=1%	-	800	-	kHz
Phase Margin	ϕ_{M1}	$R_L = 2k\Omega$ to 0V, $C_L = 0pF$	-	85	-	deg
	ϕ_{M2}	$R_L = 2k\Omega$ to 0V, $C_L = 300pF$	-	75	-	deg
Gain Margin	AM1	$R_L = 2k\Omega$ to 0V, $C_L = 0pF$	-	18	-	dB
	AM2	$R_L = 2k\Omega$ to 0V, $C_L = 300pF$	-	11	-	dB
Equivalent Input Noise Voltage	V_{NI}	$R_s = 50\Omega$, $f = 1kHz$	-	24	-	nV/\sqrt{Hz}
Total Harmonic Distortion	THD	$G_v = +10$, $R_L = 2k\Omega$ to 0V $V_o = 20V_{pp}$, $f = 10kHz$	-	0.03	-	%
Input Capacitance	c_i	$V_{ICM} = 0V$, $f = 1MHz$, $V_{inpower} = 0dBm$	-	4.5	-	pF
Channel Separation	CT	$f = 20 \sim 20kHz$, $R_L = 2k\Omega$	-	120	-	dB

●TRANSIENT CHARACTERISTICS ($V^+V^- = \pm 15V$, $T_a = 25^\circ C$)

PARAMETER	SYMBOL	TEST CONDITION	MIN.	TYP.	MAX.	UNIT
Slew Rate 1	SR1P	$V_{in} = 1V_{pp}$ (-0.5V to +0.5V), $G_v = +1$, $R_L = 2k\Omega$ to 0V, $C_L = 500pF$	-	3.5	-	$V/\mu s$
	SR1N	$V_{in} = 1V_{pp}$ (-0.5V to +0.5V), $G_v = -1$, $R_L = 2k\Omega$ to 0V, $C_L = 500pF$	-	3.5	-	$V/\mu s$
Slew Rate 2	SR2P	$V_{in} = 20V_{pp}$ (-10V to +10V), $G_v = +1$, $R_L = 2k\Omega$ to 0V, $C_L = 500pF$	-	9	-	$V/\mu s$
	SR2N	$V_{in} = 20V_{pp}$ (-10V to +10V), $G_v = -1$, $R_L = 2k\Omega$ to 0V, $C_L = 500pF$	-	9	-	$V/\mu s$
Settling time(0.1%)	$ts1$	$V_{in} = 10V_{pp}$, $G_v = -1$, $R_{in} = 1k\Omega$, $R_f = 1k\Omega$, $R_g = 5k\Omega$, $C_L = 470pF$	-	0.9	-	μs
Settling time(0.01%)	$ts2$	$V_{in} = 10V_{pp}$, $G_v = -1$, $R_{in} = 1k\Omega$, $R_f = 1k\Omega$, $R_g = 5k\Omega$, $C_L = 470pF$	-	1.9	-	μs

NJM2718

■ ELECTRICAL CHARACTERISTICS

●DC CHARACTERISTICS ($V^+=+5V$, $V^-=0V$, $T_a=25^\circ C$)

PARAMETER	SYMBOL	TEST CONDITION	MIN.	TYP.	MAX.	UNIT
Supply Current	I_{CC}	No Signal	-	2.8	3.5	mA
Input Offset Voltage	V_{IO}	$R_s=50\Omega$	-	1	4	mV
Input Offset Voltage Drift	$\Delta V_{IO}/\Delta T$	$R_s=50\Omega$	-	10	-	$\mu V/deg$
Input Bias Current	I_B	$R_s=50\Omega$	-	1	4	μA
Input Offset Current	I_{IO}	$R_s=50\Omega$	-	0.1	1.8	μA
Voltage Gain	A_v	$R_L \geq 2k\Omega$, $V_o=1.5V$ to $3.5V$, $R_s=50\Omega$	80	100	-	dB
Common Mode Rejection Ratio	CMR	$0V \leq V_{ICM} \leq 3V$, $R_s=50\Omega$	65	80	-	dB
Supply Voltage Rejection Ratio	SVR	$\pm 1.5V \leq V^+ / V^- \leq \pm 2.5V$, $R_s=50\Omega$	70	85	-	dB
Maximum Output Voltage 1	V_{OH1}	$R_L=2k\Omega$ to $0V$	3.7	4	-	V
	V_{OL1}	$R_L=2k\Omega$ to $0V$	-	0.1	0.2	V
Output Source Current	I_{source}	$V_{in}=+1V$, $V_{in}=0V$, $V_o=+2.5V$	10	20	-	mA
Output Sink Current	I_{sink}	$V_{in}=0V$, $V_{in}=+1V$, $V_o=+2.5V$	20	30	-	mA
Common Mode Input Voltage	V_{ICM}	CMR ≥ 65 dB	0	-	3	V

●AC CHARACTERISTICS ($V^+=+5V$, $V^-=0V$, $T_a=25^\circ C$)

PARAMETER	SYMBOL	TEST CONDITION	MIN.	TYP.	MAX.	UNIT
Gain Bandwidth Product	GBW	$f=100kHz$	-	1.7	-	MHz
Power Band1	PBW1	$G_v=+1$, $R_L=2k\Omega$ to $2.5V$, $V_o=2V_{pp}$, THD=1%	-	600	-	kHz
Phase Margin	$\phi M1$	$R_L=2k\Omega$ to $2.5V$, $C_L=0pF$	-	75	-	deg
	$\phi M2$	$R_L=2k\Omega$ to $2.5V$, $C_L=300pF$	-	70	-	deg
Gain Margin	AM1	$R_L=2k\Omega$ to $2.5V$, $C_L=0pF$	-	17	-	dB
	AM2	$R_L=2k\Omega$ to $2.5V$, $C_L=300pF$	-	11	-	dB
Equivalent Input Noise Voltage	V_{NI}	$R_s=50\Omega$, $f=1kHz$	-	24	-	nV/\sqrt{Hz}
Total Harmonic Distortion	THD	$G_v=+10$, $R_L=2k\Omega$ to $2.5V$, $V_o=3V_{pp}$, $f=10kHz$	-	0.05	-	%
Input Capacitance	c_i	$V_{cm}=0V$, $f=1MHz$, $V_{inpower}=0dBm$	-	5	-	pF
Channel Separation	CT	$f=10kHz$	-	110	-	dB

●TRANSIENT CHARACTERISTICS ($V^+=+5V$, $V^-=0V$, $T_a=25^\circ C$)

PARAMETER	SYMBOL	TEST CONDITION	MIN.	TYP.	MAX.	UNIT
Slew Rate 1	$SR1_P$	$V_{in}=1V_{pp}$ (+2V to +3V), $G_v=+1$, $R_L=2k\Omega$ to $0V$, $C_L=500pF$	-	3	-	$V/\mu s$
	$SR1_N$	$V_{in}=1V_{pp}$ (+2V to +3V), $G_v=-1$, $R_L=2k\Omega$ to $0V$, $C_L=500pF$	-	2.5	-	$V/\mu s$
Settling time(0.1%)	$ts1$	$V_{in}=1V_{pp}$, $G_v=-1$, $R_{in}=1k\Omega$, $R_f=1k\Omega$, $R_g=5k\Omega$, $C_L=470pF$	-	1.5	-	μs
Settling time(0.01%)	$ts2$	$V_{in}=1V_{pp}$, $G_v=-1$, $R_{in}=1k\Omega$, $R_f=1k\Omega$, $R_g=5k\Omega$, $C_L=470pF$	-	3	-	μs

■ TYPICAL CHARACTERISTICS

Supply Current vs. Supply Voltage (Temperature)
 $V_{IN}=0, R_S=50\Omega$

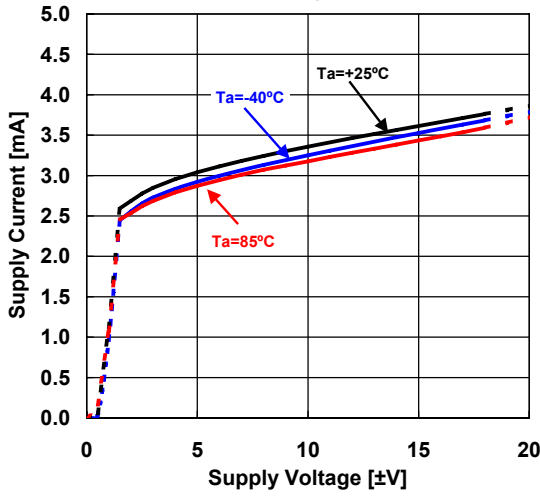

Supply Current vs. Temperature (supply Voltage)
 $V_{IN}=0, R_S=50\Omega$

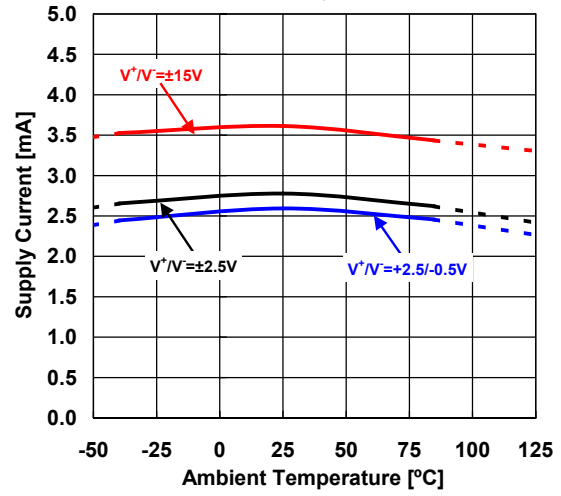

Input Offset Voltage vs. Temperature
 $V^*/V = \pm 15\text{V}, V_{ICM}=0\text{V}, n=30$

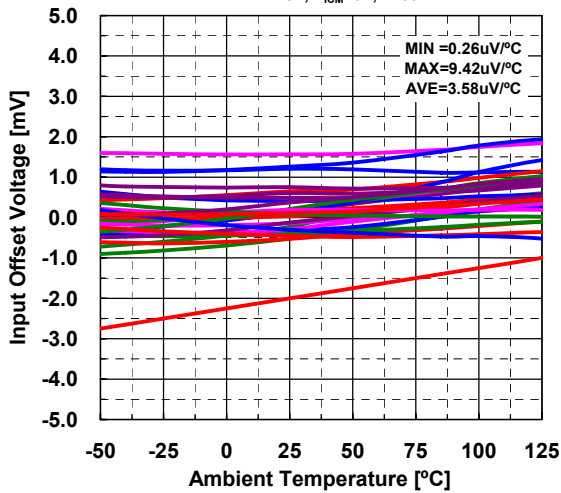

Input Offset Voltage vs. Temperature
 $V^*/V = \pm 2.5\text{V}, V_{ICM}=0\text{V}, n=30$

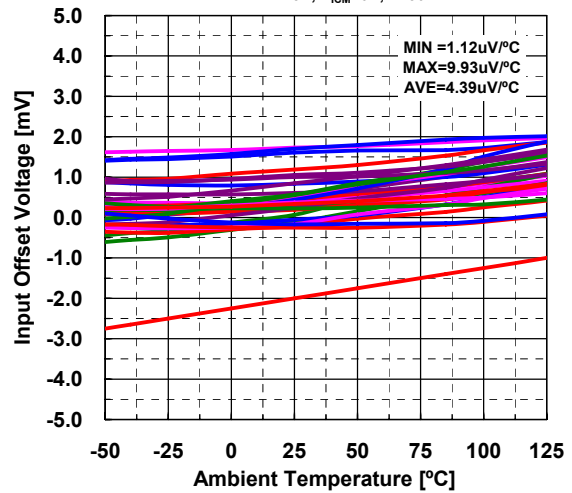

Input Bias Current vs. Temperature (Supply Voltage)
 $V_{IN}=0\text{V}, R_S=50\Omega$

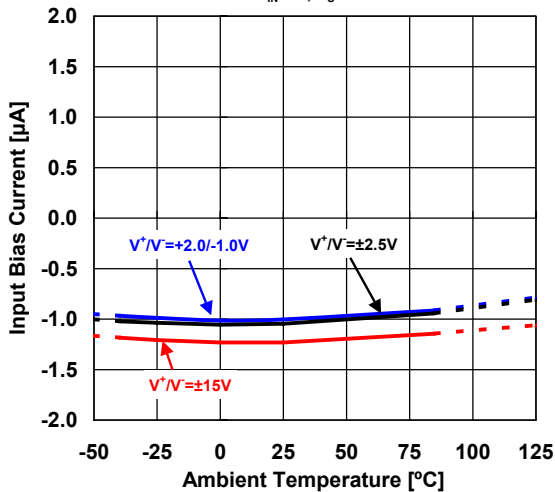

Input Offset Current vs. Temperature (Supply Voltage)
 $V_{IN}=0\text{V}, R_S=50\Omega$

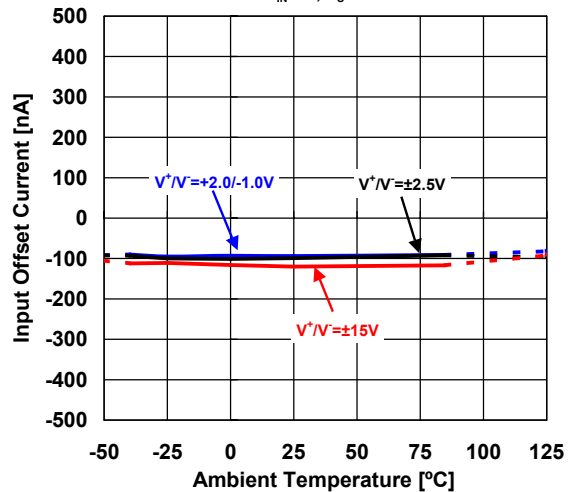

■ TYPICAL CHARACTERISTICS

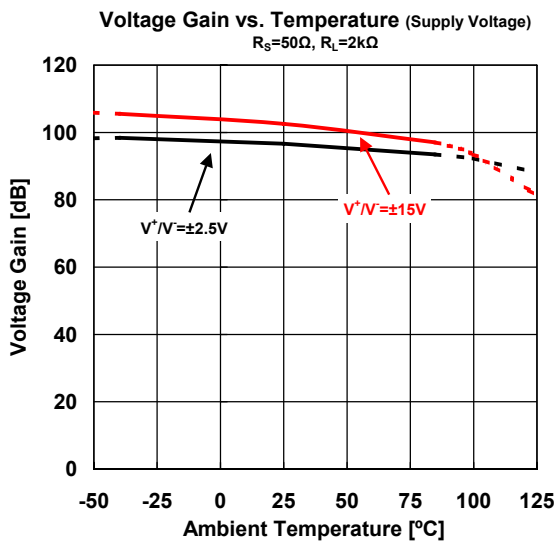
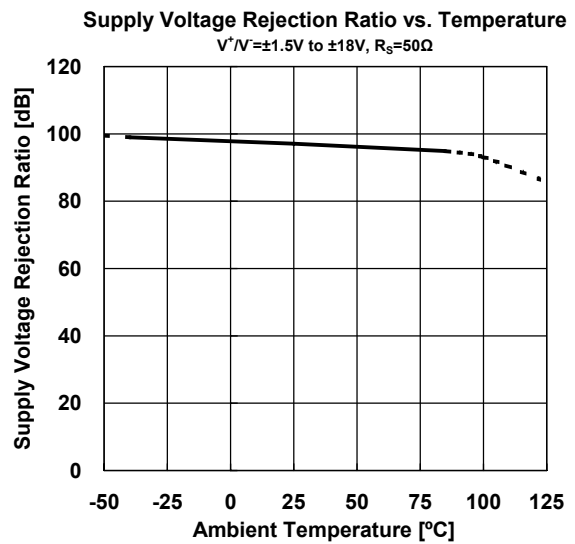
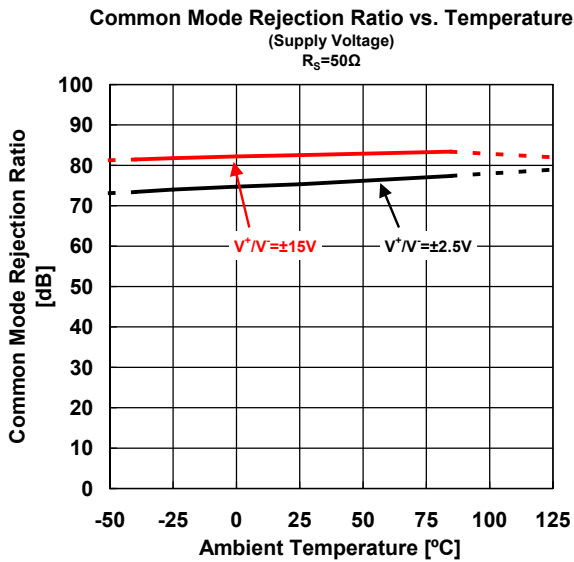
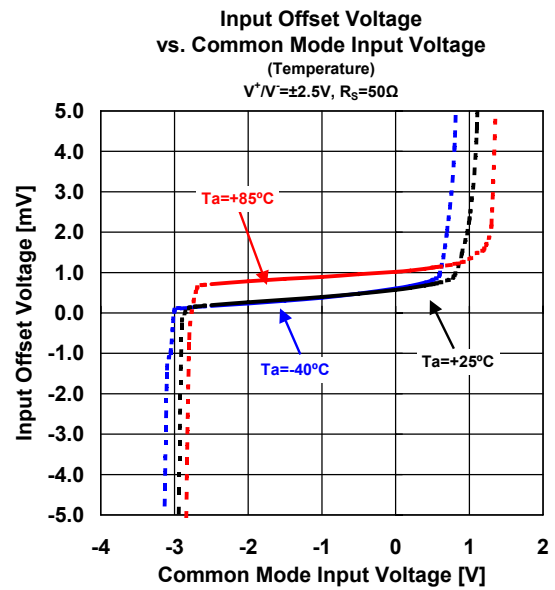
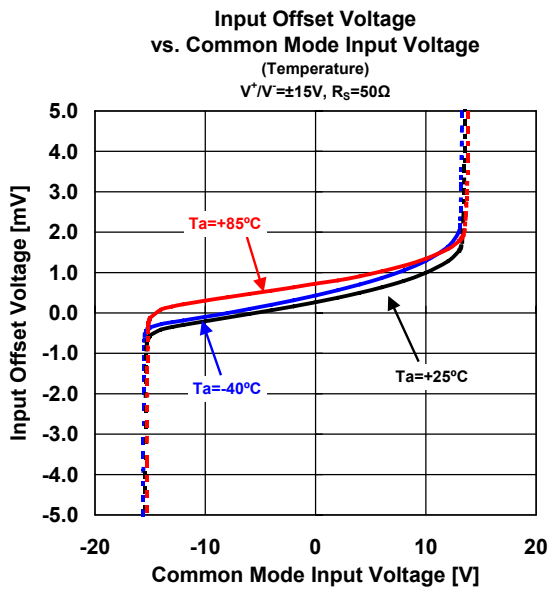

■ TYPICAL CHARACTERISTICS

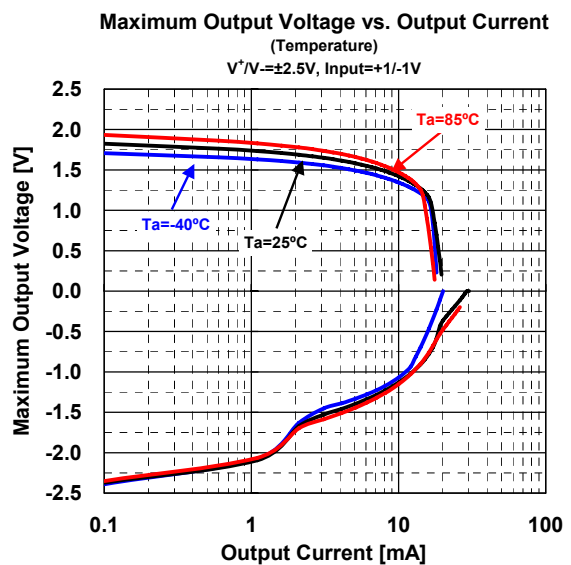
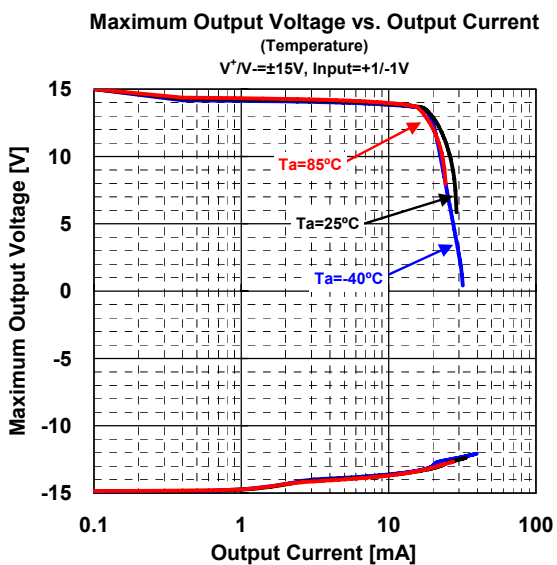
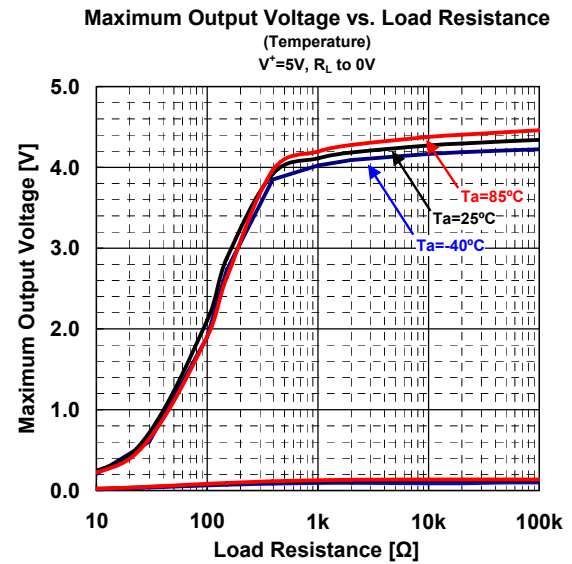
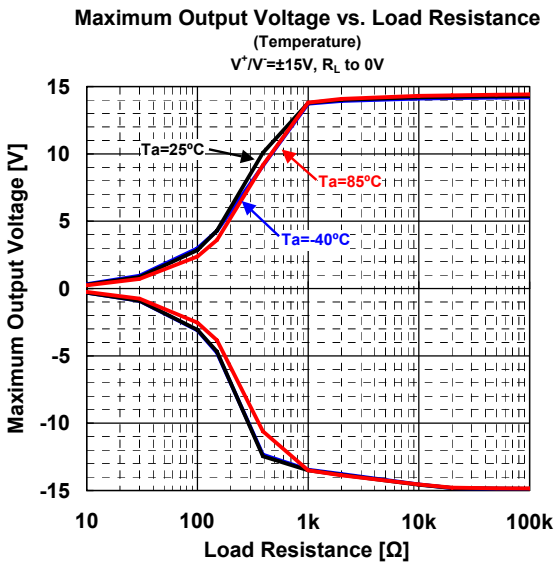
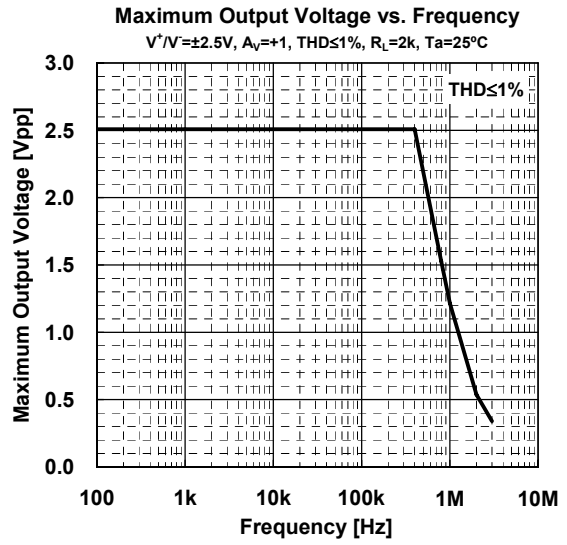
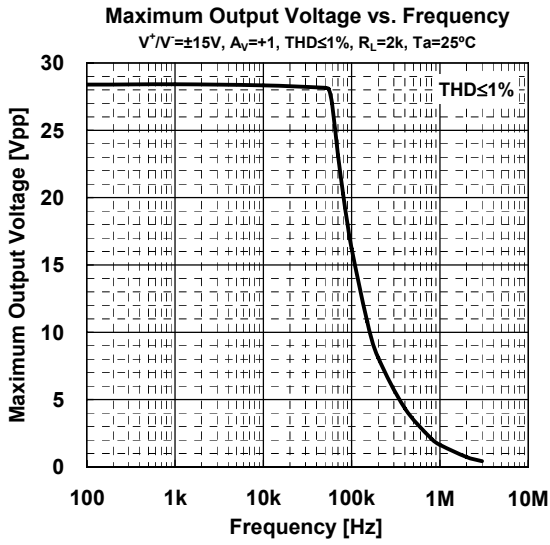

■ TYPICAL CHARACTERISTICS

40dB Gain/Phase vs. Frequency (Load Capacitance)

$V^+/V^-=\pm 15V$, $V_{IN}=20dBm$, $R_G=20\Omega$,
 $R_F=2k\Omega$, $R_L=2k\Omega$ to 0V, $T_a=25^\circ C$

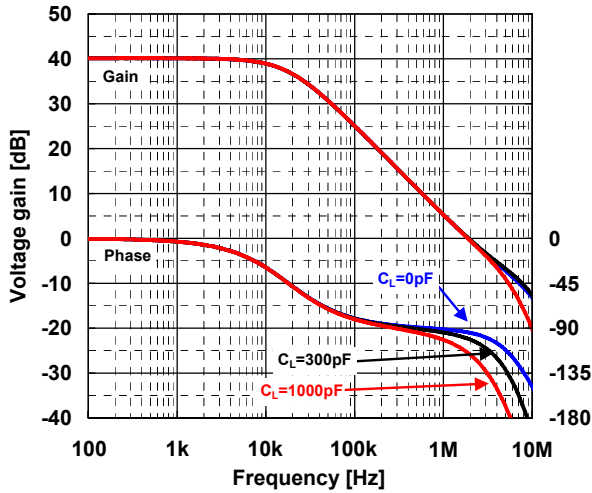

40dB gain/Phase vs. Frequency (Load Capacitance)

$V^+/V^-=\pm 2.5V$, $V_{IN}=20dBm$, $R_G=20\Omega$,
 $R_F=2k\Omega$, $R_L=2k\Omega$ to 0V, $T_a=25^\circ C$

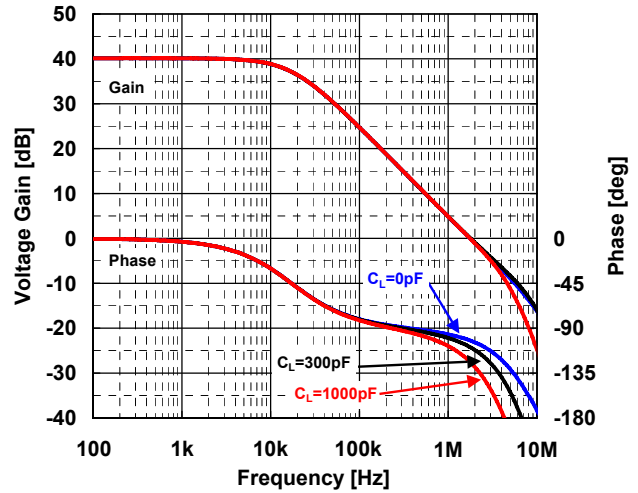

THD vs. Output Voltage (Frequency)

$V^+/V^-=\pm 15V$, $V_{IN}=2Vpp$, $A_V=20dB$, $V_O=20Vpp$,
 $R_1=1k\Omega$, $R_2=9k\Omega$, $R_G=1k\Omega$, $R_L=2k\Omega$,
 $BW=10\sim 500kHz$, $T_a=25^\circ C$

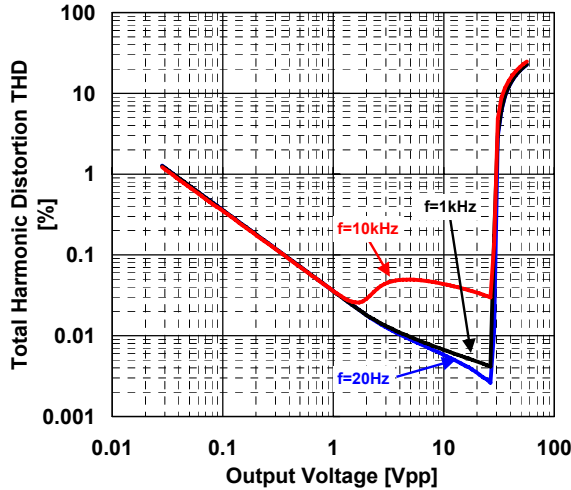

THD vs. Output Voltage (Frequency)

$V^+/V^-=\pm 2.5V$, $Z_{IN}=40\Omega$, $A_V=20dB$, $V_O=3Vpp$,
 $R_1=1k\Omega$, $R_2=9k\Omega$, $R_G=10k\Omega$, $R_L=2k\Omega$,
 $BW=10\sim 500kHz$, $T_a=25^\circ C$

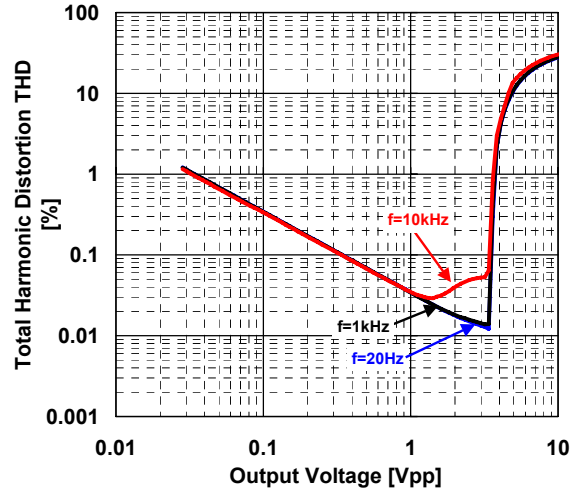

Channel Separation vs. Frequency

$V^+/V^-=\pm 15V$, $V_{IN}=200mVpp$, $Z_{IN}=20\Omega$, $A_V=40dB$, $V_O=20Vpp$,
 $R_1=1k\Omega$, $R_2=100k\Omega$, $R_G=10k\Omega$, $R_L=2k\Omega$, $BW=10\sim 500kHz$

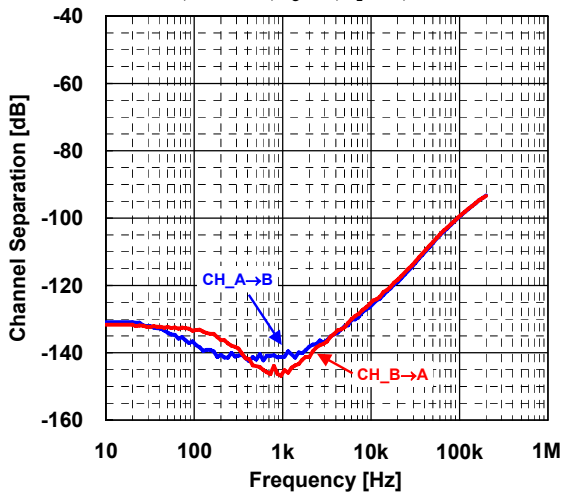

Channel Separation vs. Frequency

$V^+/V^-=\pm 2.5V$, $V_{IN}=20mVpp$, $Z_{IN}=20\Omega$, $A_V=40dB$, $V_O=2Vpp$,
 $R_1=1k\Omega$, $R_2=100k\Omega$, $R_G=10k\Omega$, $R_L=2k\Omega$, $BW=10\sim 500kHz$

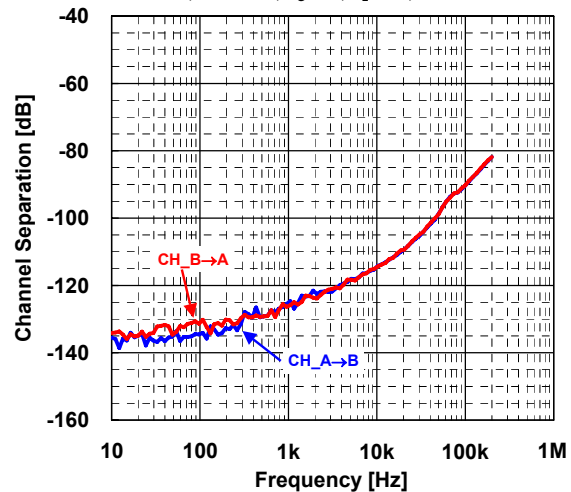

■ TYPICAL CHARACTERISTICS

Frequency Response ($V_{IN}=1V_{pp}$, Load Capacitance)
 $V^+/V^-=\pm 15V$, $V_{IN}=1V_{pp}$,
 $f=100kHz$, $A_V=+1$, $R_L=2k\Omega$ to $0V$, $T_a=25^\circ C$

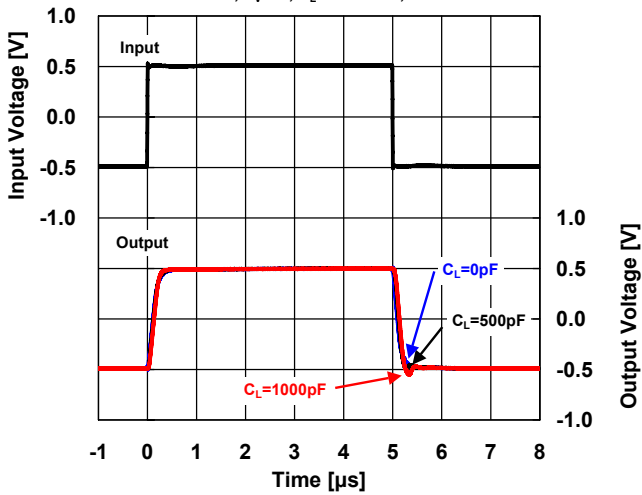

Frequency Response ($V_{IN}=1V_{pp}$, Temperature)
 $V^+/V^-=\pm 15V$, $V_{IN}=1V_{pp}$,
 $f=100kHz$, $A_V=+1$, $R_L=2k\Omega$ to $0V$, $C_L=500pF$

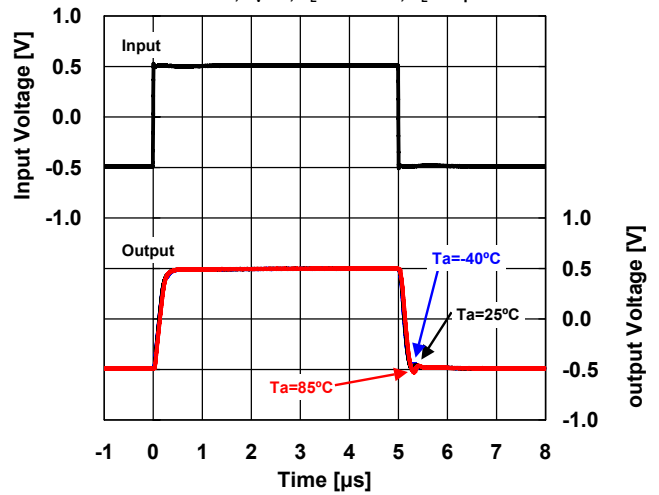

Frequency Response ($V_{IN}=20V_{pp}$, Load Capacitance)
 $V^+/V^-=\pm 15V$, $V_{IN}=20V_{pp}$,
 $f=100kHz$, $A_V=+1$, $R_L=2k\Omega$ to $0V$, $T_a=25^\circ C$,

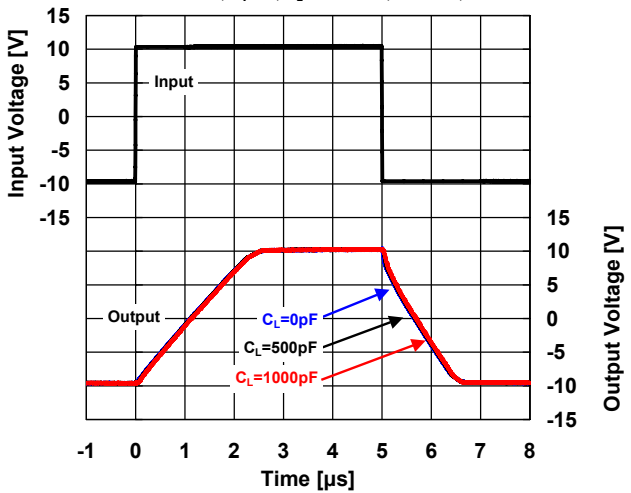

Frequency Response ($V_{IN}=20V_{pp}$, Temperature)
 $V^+/V^-=\pm 15V$, $V_{IN}=20V_{pp}$,
 $f=100kHz$, $A_V=+1$, $R_L=2k\Omega$ to $0V$, $C_L=500pF$

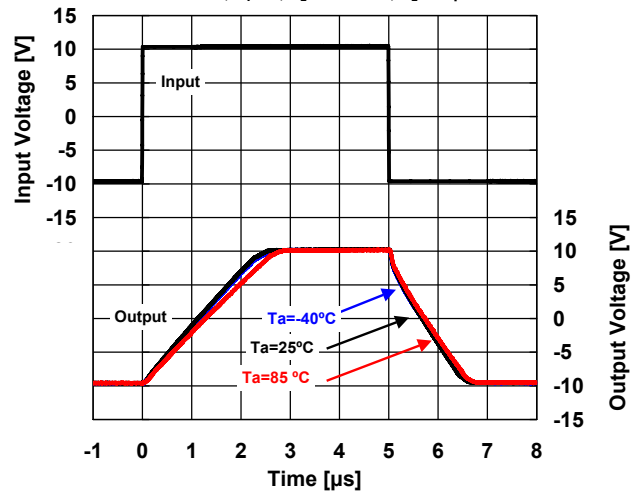

Frequency Response ($V_{IN}=1V_{pp}$, Load Capacitance)
 $V^+/V^-=\pm 2.5V$, $V_{IN}=1V_{pp}$,
 $f=100kHz$, $A_V=+1$, $R_L=2k\Omega$ to $0V$, $T_a=25^\circ C$

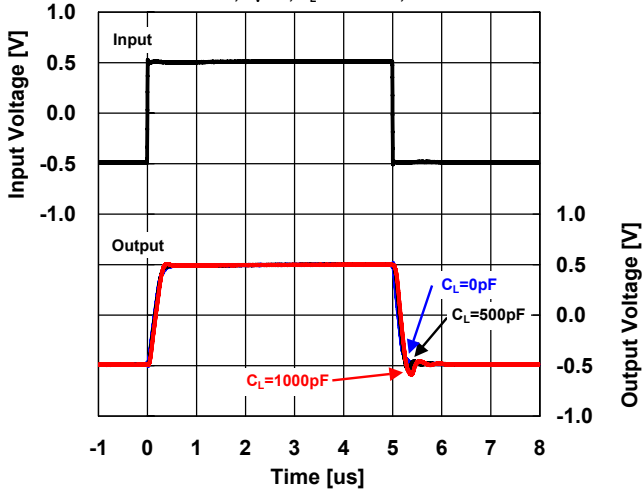

Frequency Response ($V_{IN}=1V_{pp}$, Temperature)
 $V^+/V^-=\pm 2.5V$, $V_{IN}=1V_{pp}$,
 $f=100kHz$, $A_V=+1$, $R_L=2k\Omega$ to $0V$, $C_L=500pF$

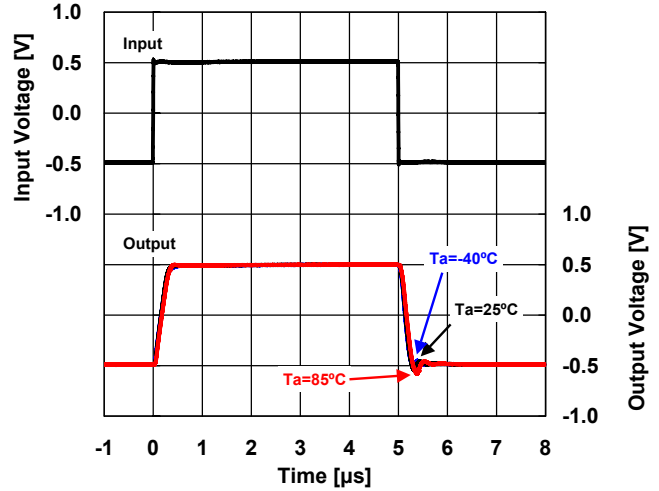

■ TYPICAL CHARACTERISTICS

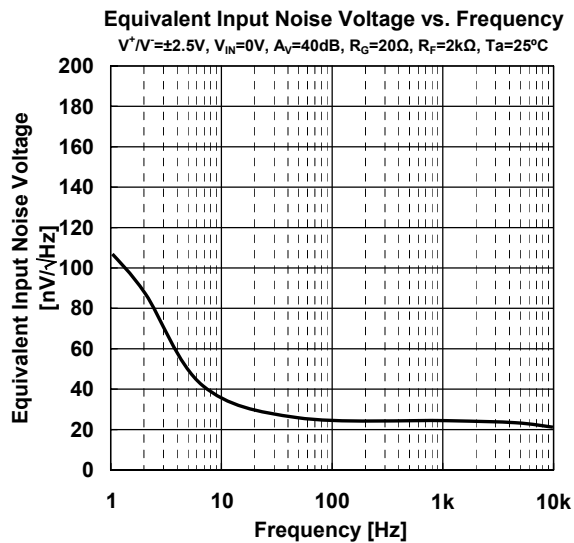
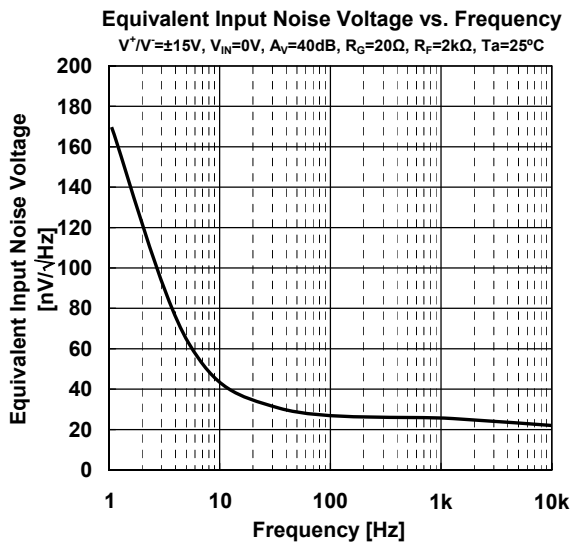

■ TEST CIRCUIT

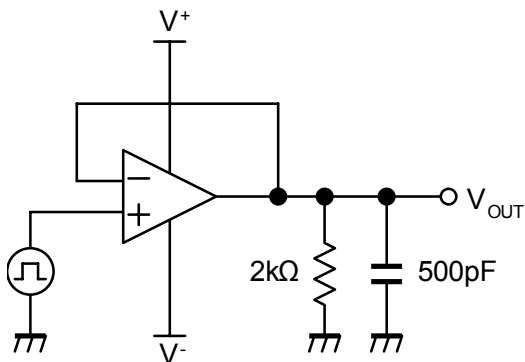

Fig.2.1 Slew Rate (Non Inverting)

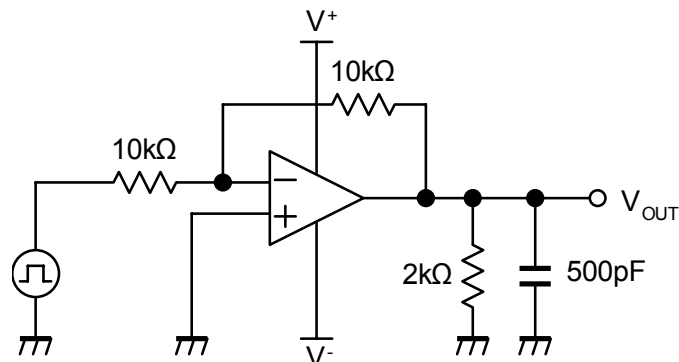

Fig.2.2 Slew Rate (Inverting)

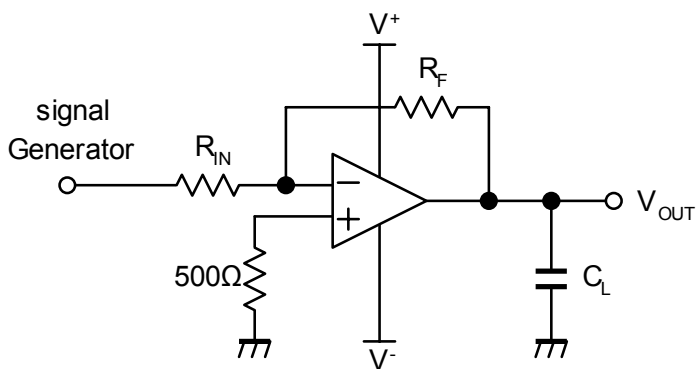

Fig.2.3 Settling Time

[CAUTION]
 The specifications on this data book are only given for information, without any guarantee as regards either mistakes or omissions. The application circuits in this data book are described only to show representative usages of the product and not intended for the guarantee or permission of any right including the industrial rights.