

## 4 INPUT 1 OUTPUT VIDEO SWITCH with ISOLATION AMP.

### ■ GENERAL DESCRIPTION

The NJM2526 is a 4-input 1-output video switch with isolation amplifier. Isolation circuit removes the noise of a signal.

The NJM2526 includes sync-tip clamp circuit. It is suitable for the change of the composite signal, synchronized signal of the Car AV equipment

### ■ PACKAGE OUTLINE



NJM2526V

### ■ FEATURES

- Operating Voltage 4.5 to 9.0V
- Internal Isolation Amp.
- Internal 4 input 1 output Video Switch
- Sync-tip Clamp
- Bipolar Technology
- Package Outline SSOP16

### ■ BLOCK DIAGRAM

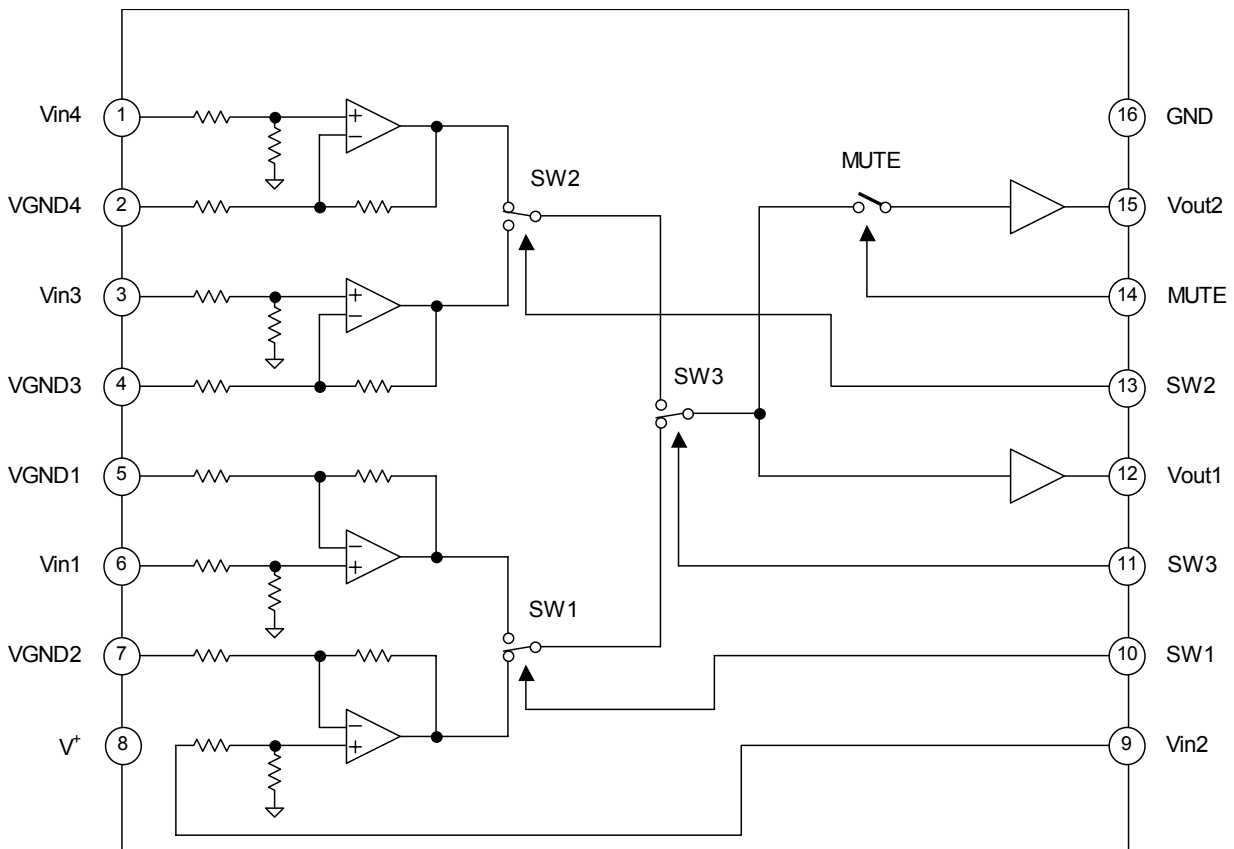

# NJM2526

## ■ ABSOLUTE MAXIMUM RATINGS (Ta=25°C)

PARAMETER	SYMBOL	RATING	UNIT
Supply Voltage	V <sup>+</sup>	15.0	V
Power Dissipation	P <sub>D</sub>	300	mW
Operating Temperature Range	T <sub>opr</sub>	-40 to +85	°C
Storage Temperature Range	T <sub>stg</sub>	-40 to +125	°C

## ■ RECOMMENDED OPERATING CONDITION (Ta=25°C)

PARAMETER	SYMBOL	TEST CONDITION	MIN.	TYP.	MAX.	UNIT
Operating Voltage	V <sub>opr</sub>		4.5	-	9.0	V

## ■ ELECTRICAL CHARACTERISTICS (V<sup>+</sup>=5.0V, Ta=25°C)

PARAMETER	SYMBOL	TEST CONDITION	MIN.	TYP.	MAX.	UNIT
Operating Current	I <sub>CC</sub>	No Signal	-	10	15	mA
Maximum Output Level	V <sub>om1</sub>	Vin=100kHz, Sigh-Signal, THD=1%,	2.0	2.2	-	Vp-p
Voltage Gain	G <sub>v</sub>	Vin=100kHz, 1.0Vp-p Sign-Signal	-1.0	0	1.0	dB
Frequency Characteristics	G <sub>f</sub>	Vin=10MHz / 1MHz, 1.0Vpp Sign-Signal	-1.0	0	1.0	dB
Common Mode Rejection Ratio	CMR	Vin=20kHz, 1.0Vpp	-	-50	-	dB
Crosstalk Between Input	CT-I	Vin=4.43MHz, 1.0Vp-p Sign-Signal	-	-65	-	dB
Differential Gain	DG	Vin=1.0Vp-p 10step Video Signal	-	0.3	-	%
Differential Phase	DP	Vin=1.0Vp-p 10step Video Signal	-	0.4	-	deg
SW Change High Level	V <sub>thH</sub>		2.0	-	V <sup>+</sup>	V
SW Change Low Level	V <sub>thL</sub>		0	-	0.6	V

## ■ SW vs. INPUT/OUTPUT (X: L or H or OPEN)

SW1	SW2	SW3	MUTE	Vout1	Vout2
L	X	L	L	Vin1	Vin1
L	X	L	H	Vin1	MUTE
H	X	L	L	Vin2	Vin2
H	X	L	H	Vin2	MUTE
X	L	H	L	Vin3	Vin3
X	L	H	H	Vin3	MUTE
X	H	H	L	Vin4	Vin4
X	H	H	H	Vin4	MUTE

## APPLICATION

Please connect input surge resistance to 1,3,6,9pin(Vin) and 2,4,5,7pin(VGND). Please refer to Fig. 1. If resistance is enlarged, a waveform may deteriorate.

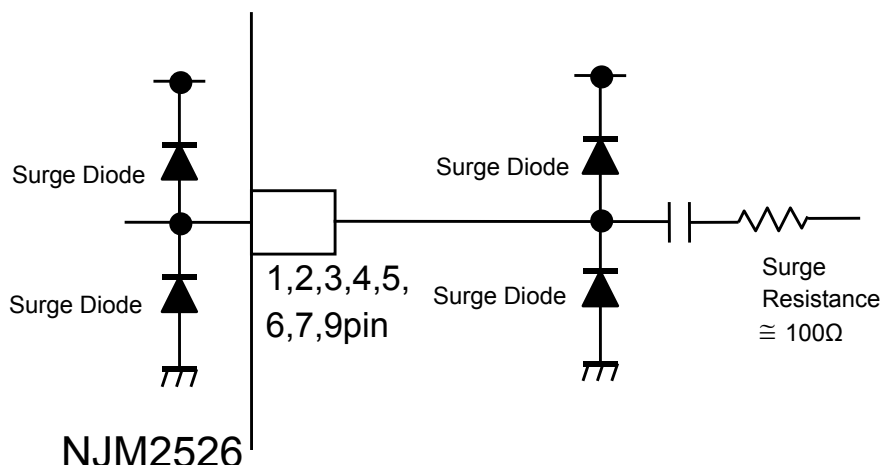

Fig1: External connection

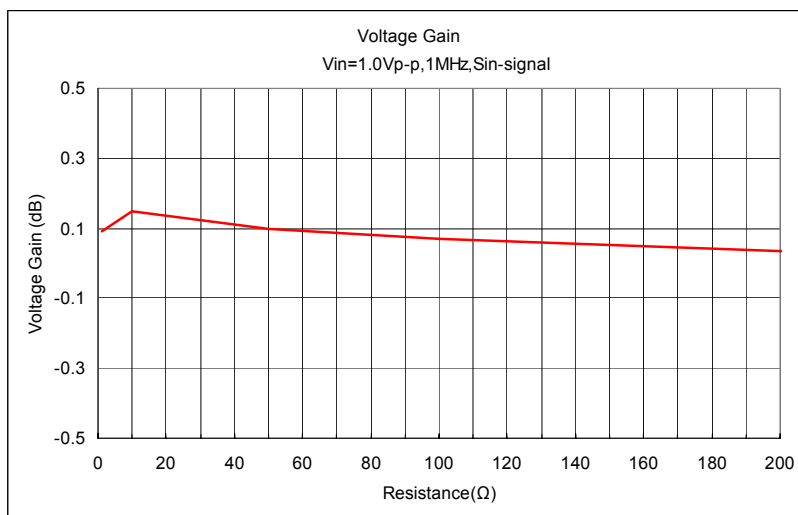

Fig2: Input resistance vs. Voltage gain

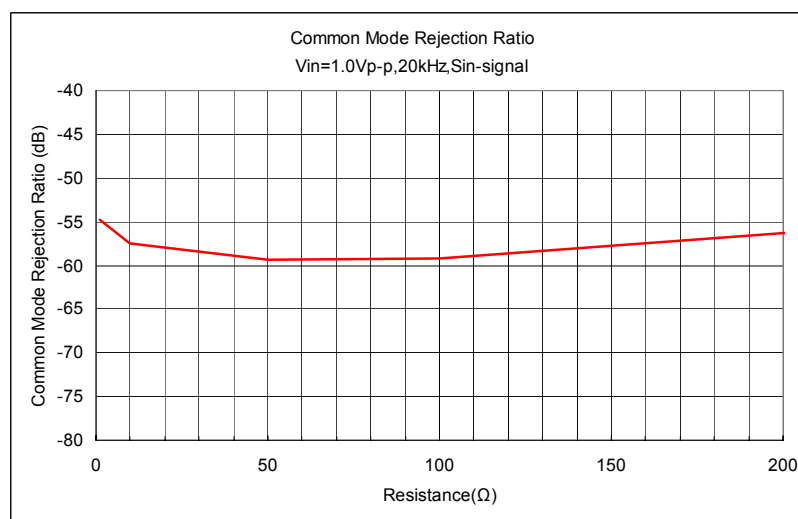
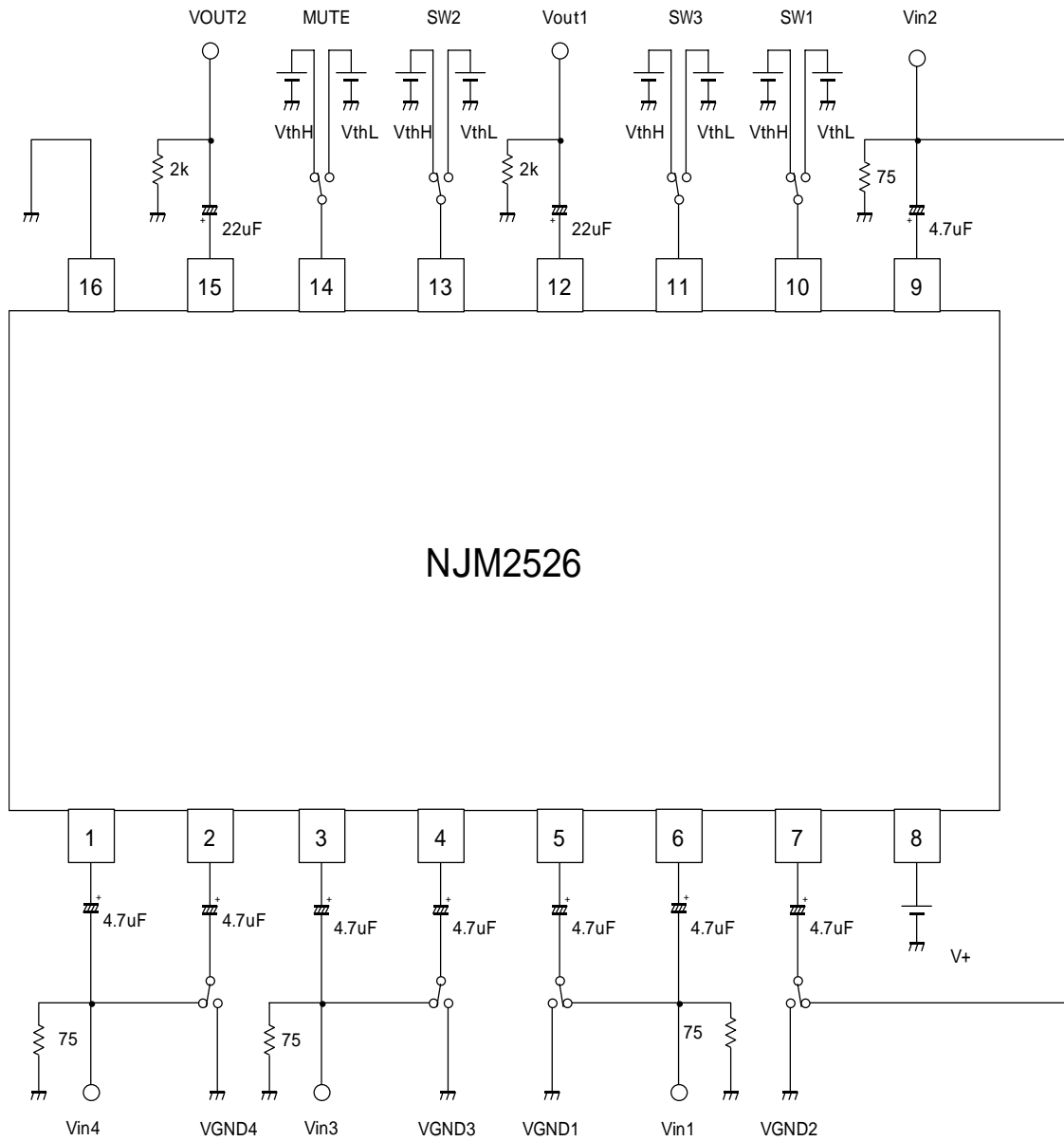

Fig3: Input resistance vs. Common mode rejection ratio

# NJM2526

## TEST CIRCUIT 1



## TEST CIRCUIT 2 (measure on CMR)

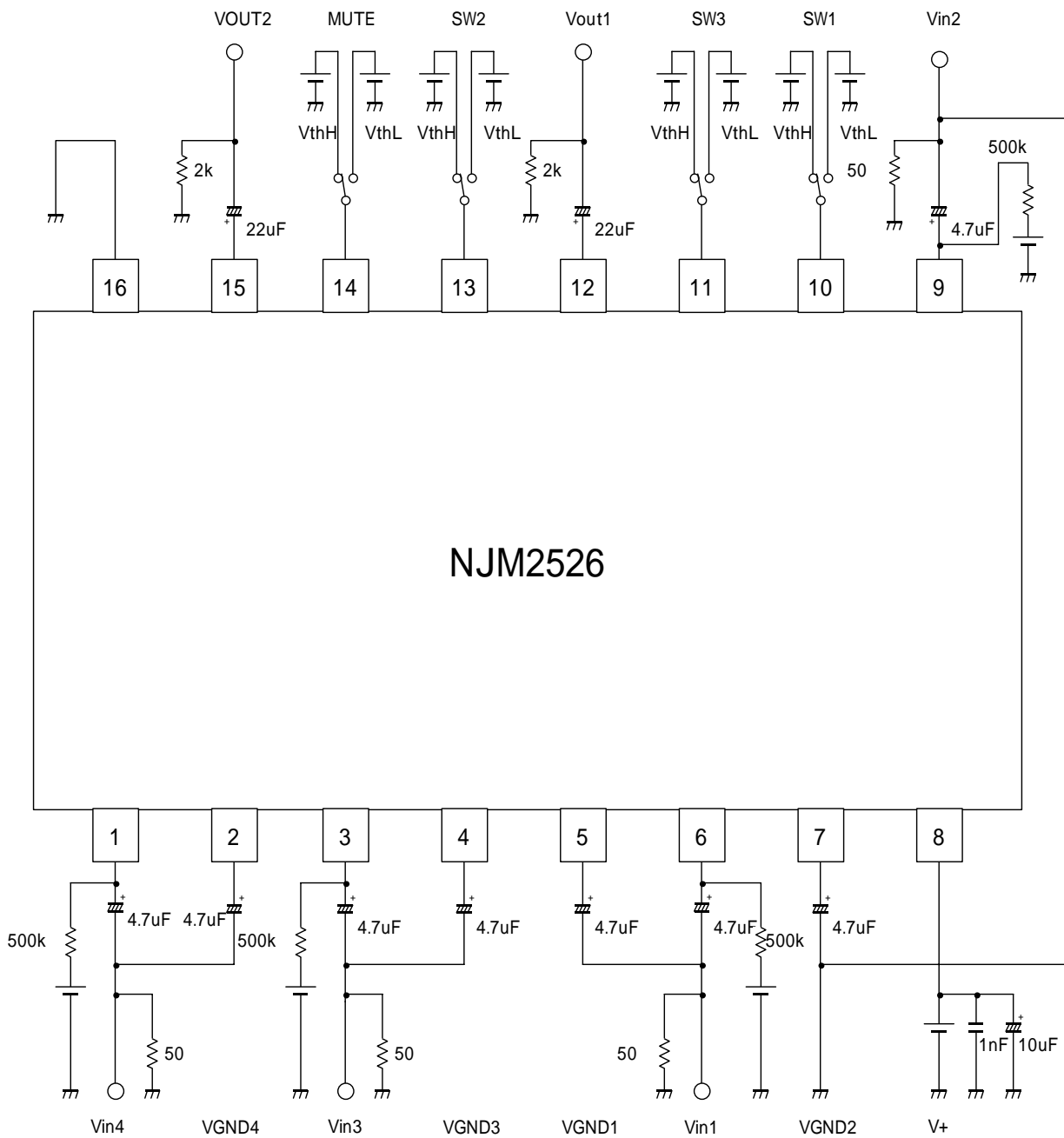

# NJM2526

## APPLICATION CIRCUIT

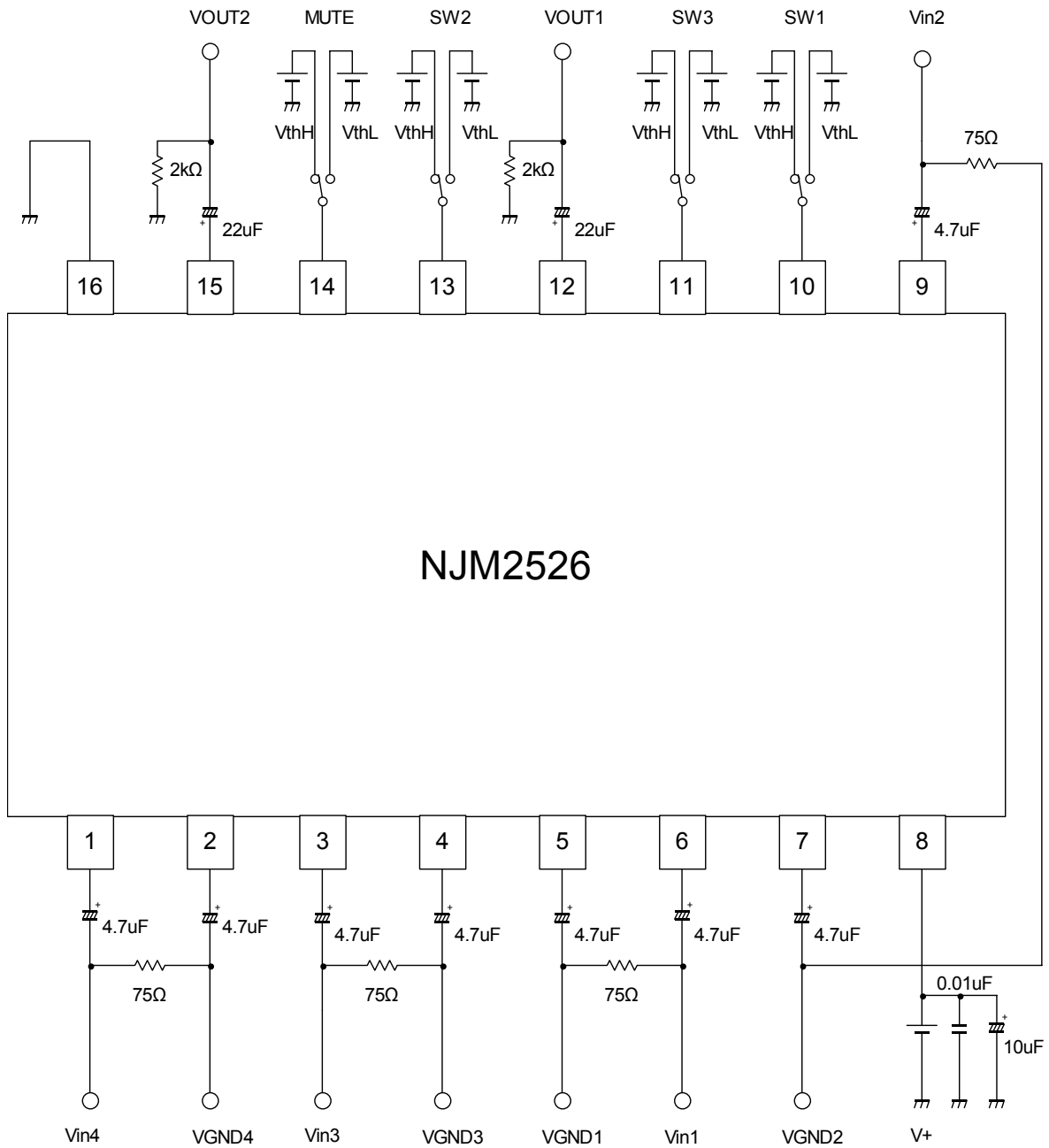

## ■ EQUIVALENT CIRCUIT

Pin No.	Symbol	Inside Equivalent Circuit	Voltage
1 3 6 9	Vin4 Vin3 Vin1 Vin2		1.64V
2 4 5 7	VGND4 VGND3 VGND1 VGND2		1.63V
8	V <sup>+</sup>		-
10 11 13 14	SW1 SW3 SW2 MUTE		-
12 15	Vout1 Vout2		0.87V
16	GND		-

## ■ TYPICAL CHARACTERISTICS

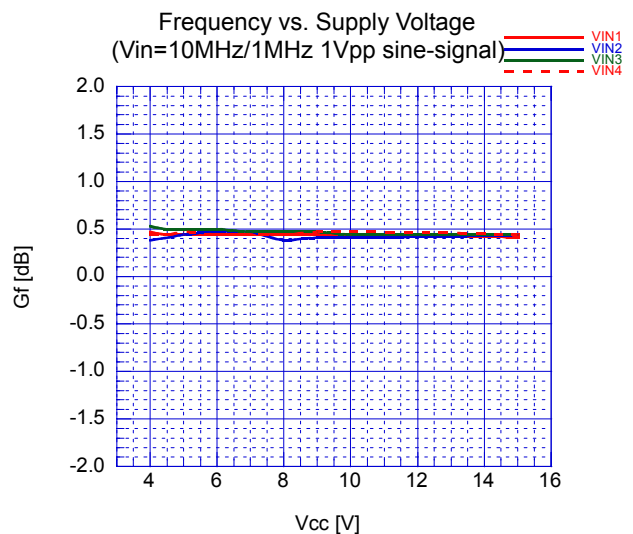
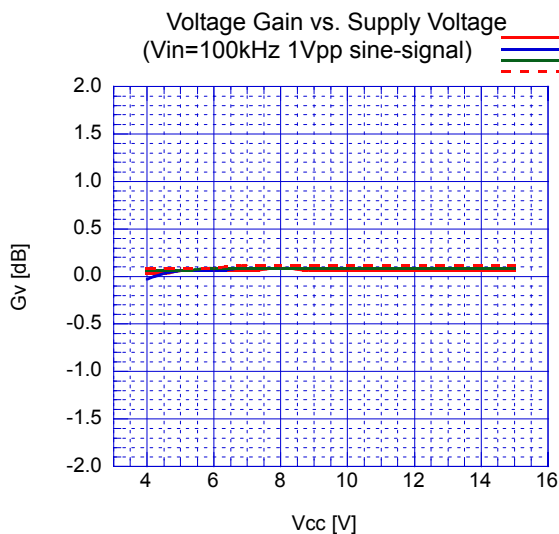
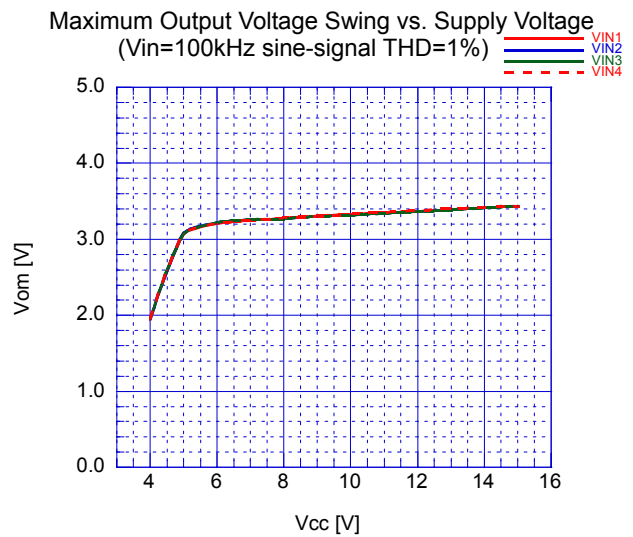
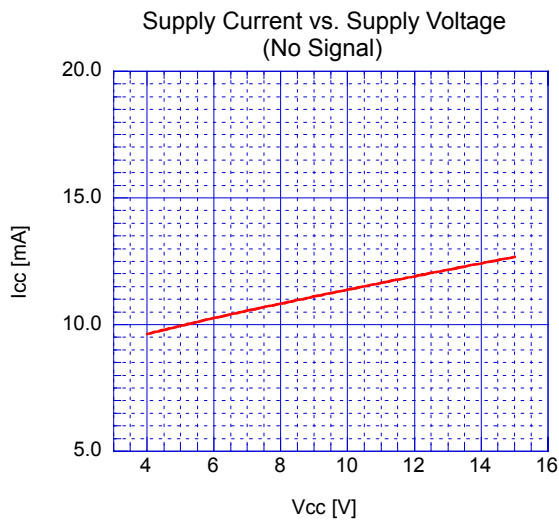
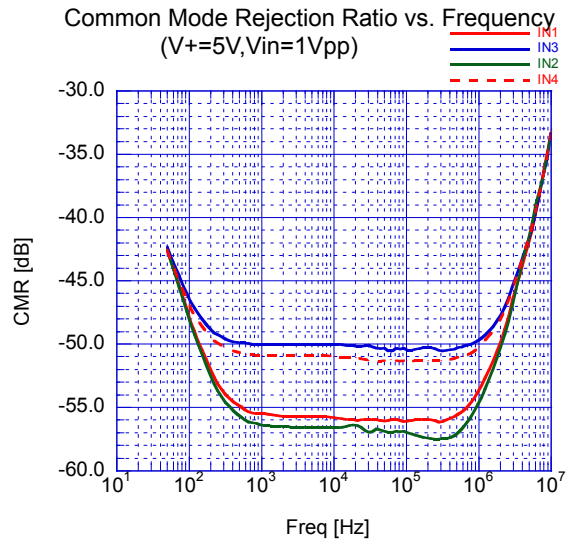
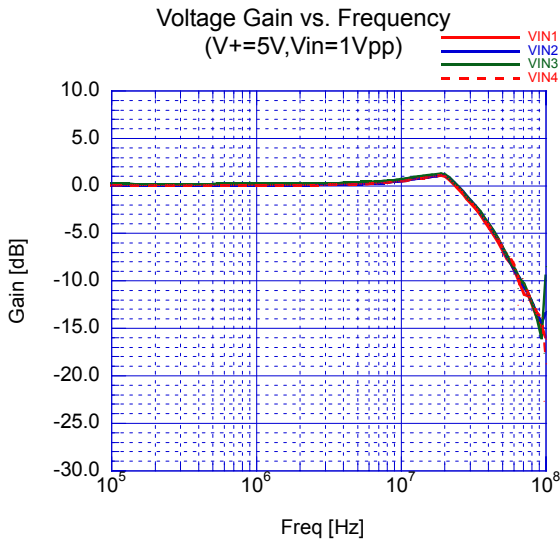



## ■ TYPICAL CHARACTERISTICS

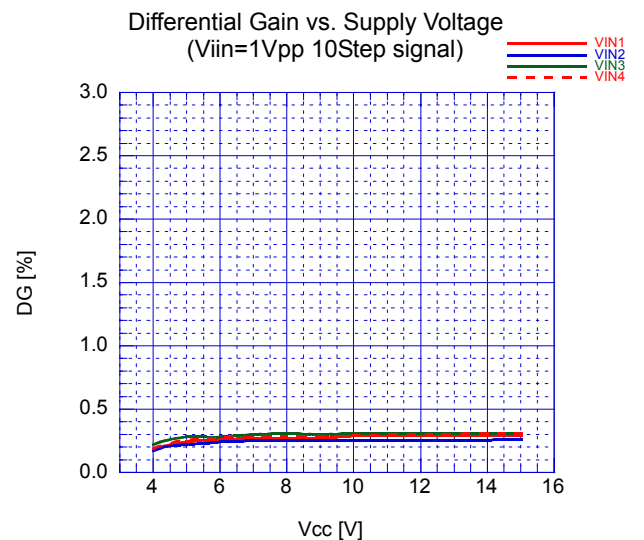
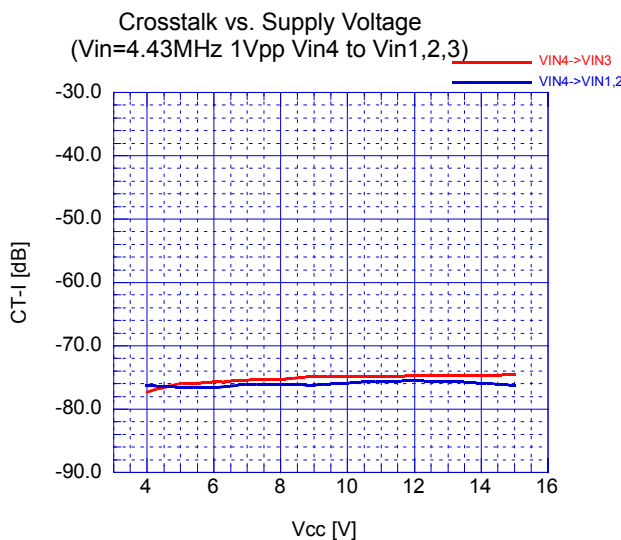
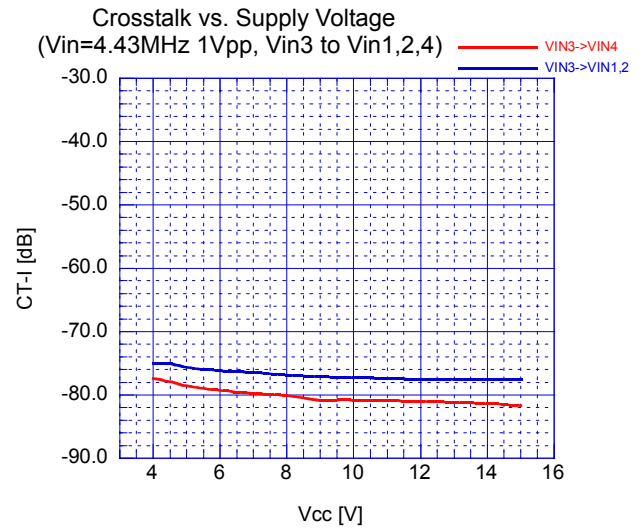
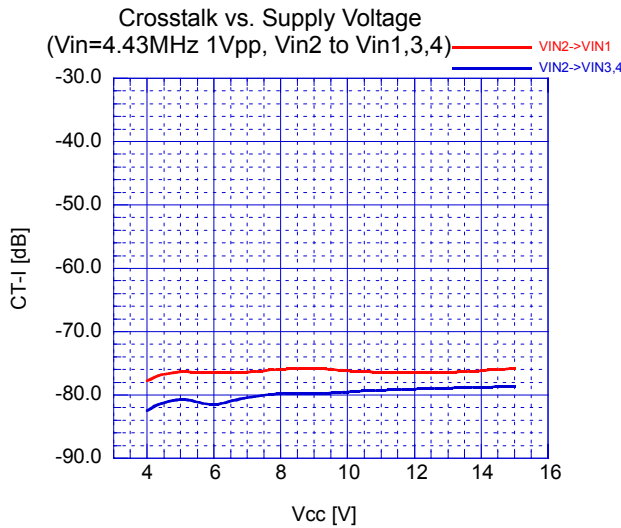
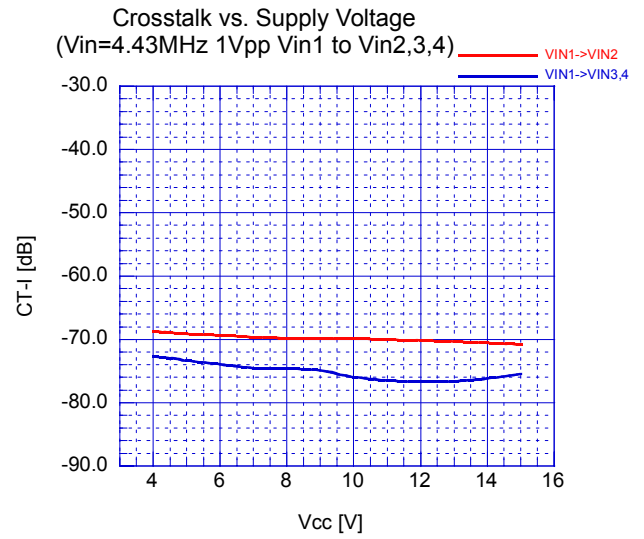
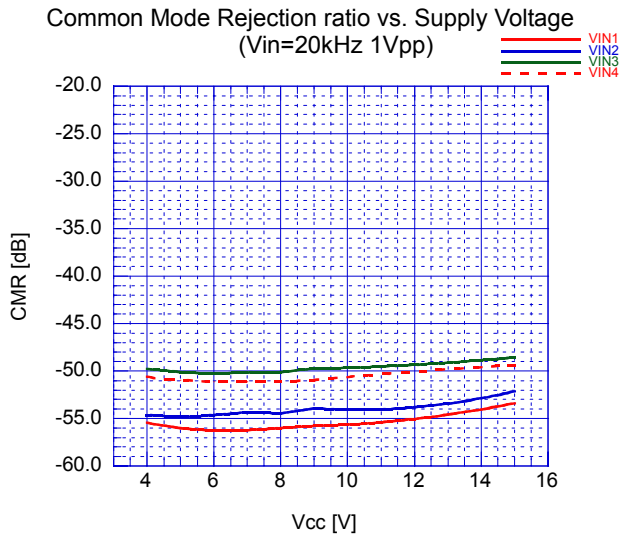

## ■ TYPICAL CHARACTERISTICS

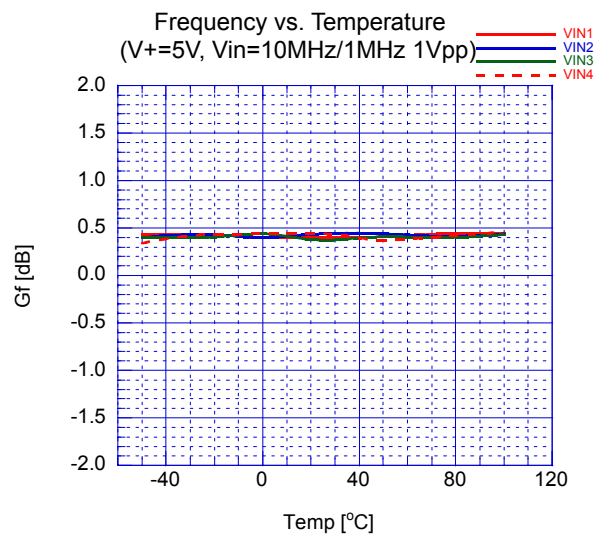
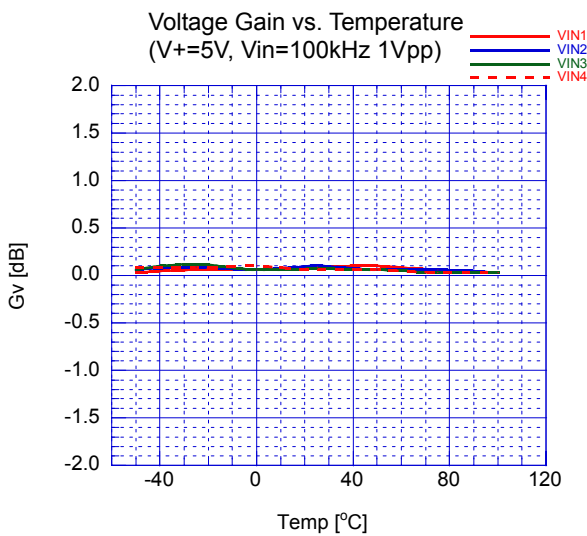
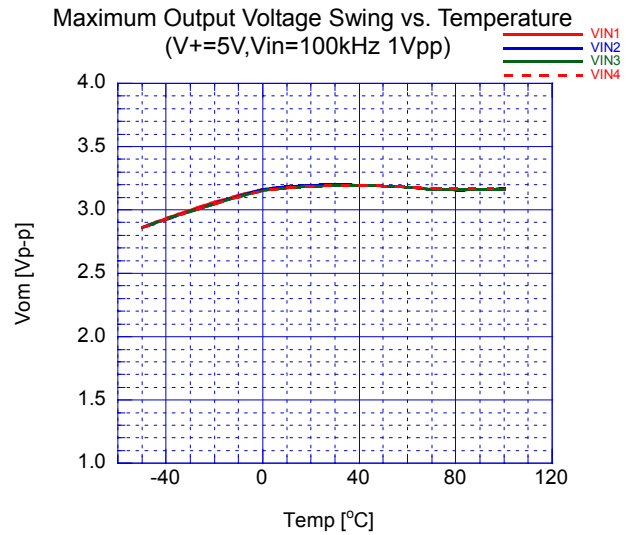
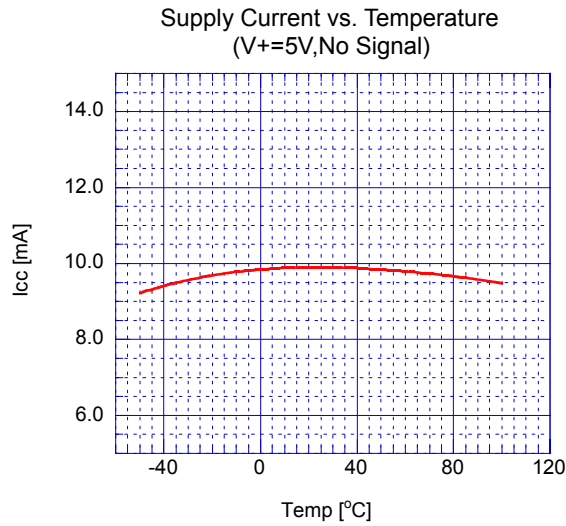
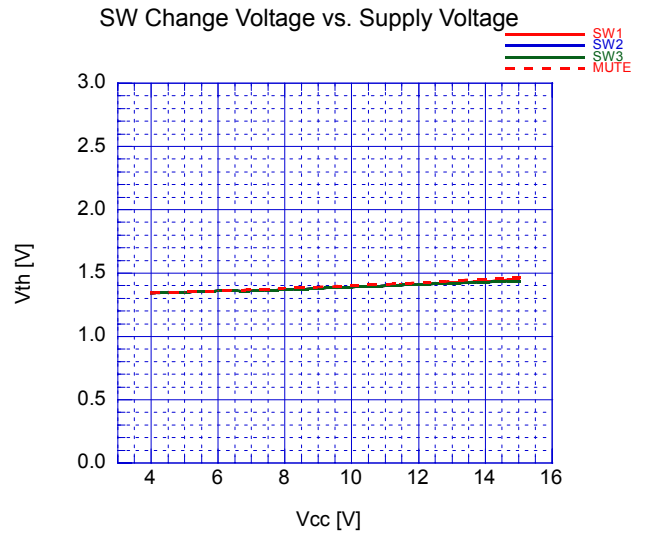
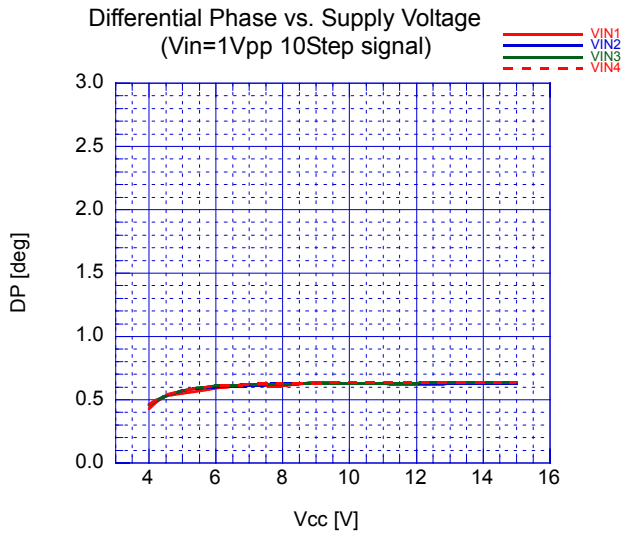

## TYPICAL CHARACTERISTICS

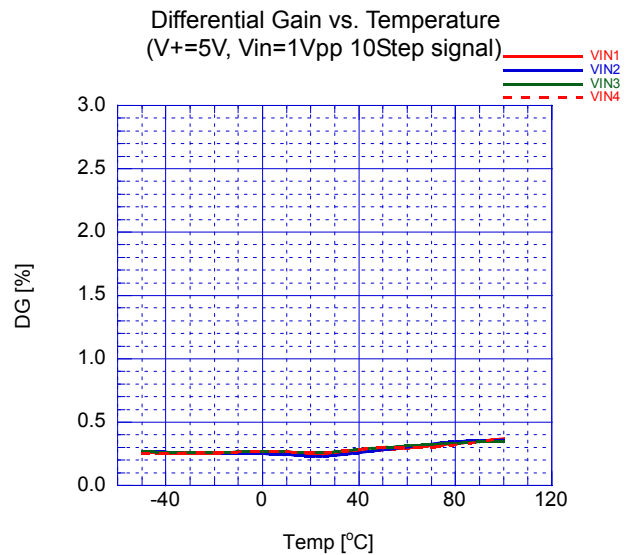
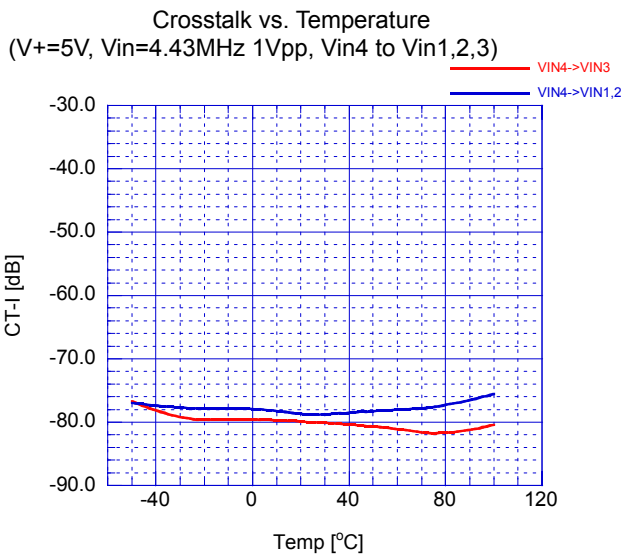
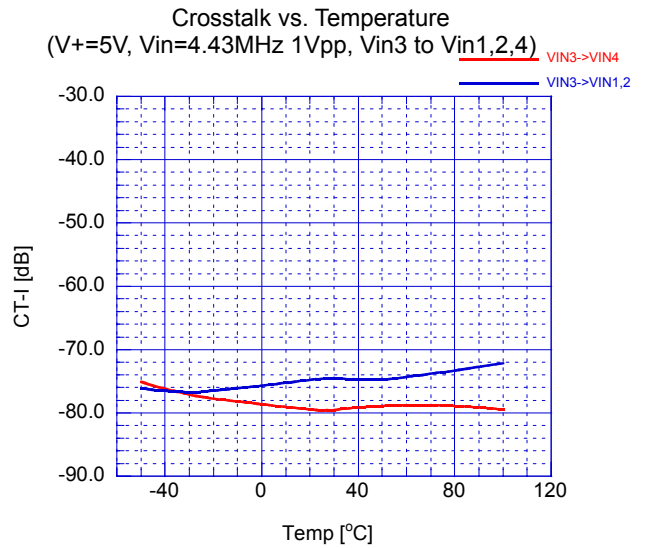
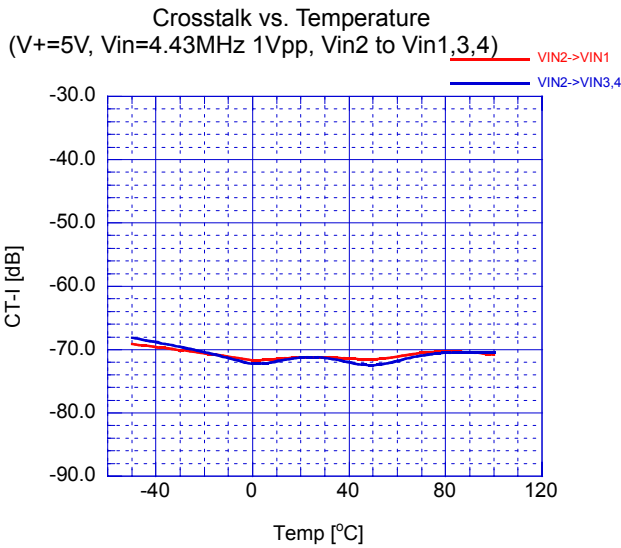
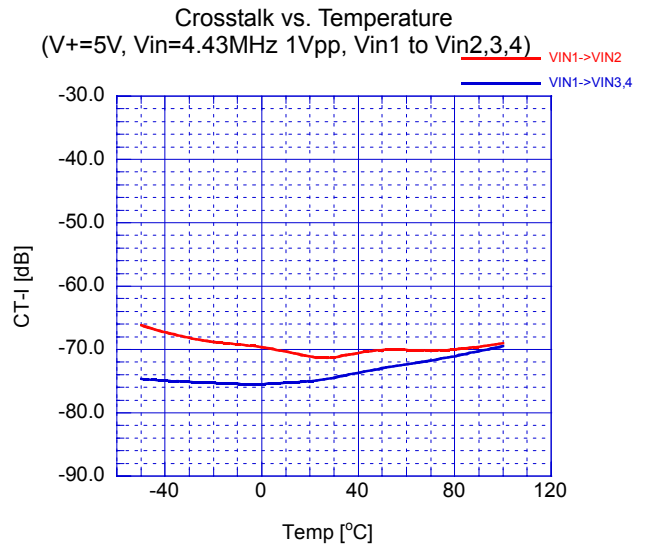
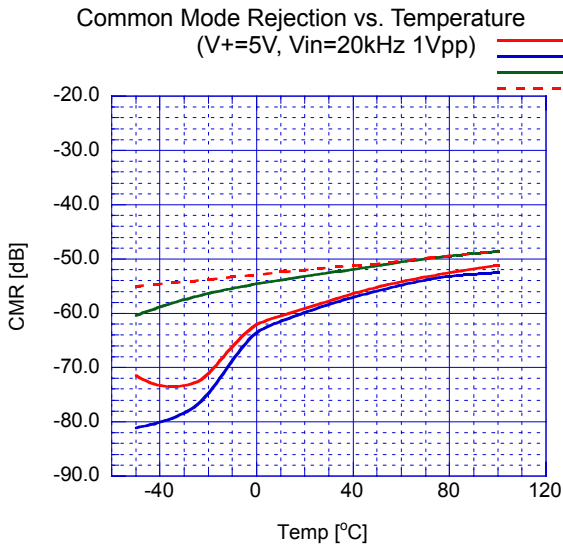

## ■ TYPICAL CHARACTERISTICS

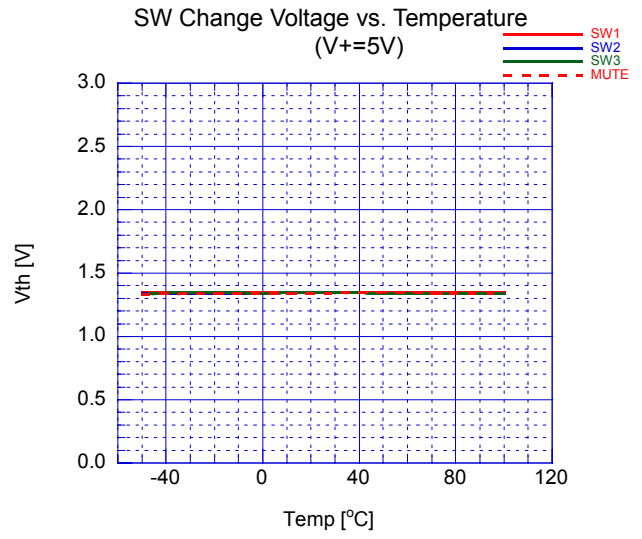
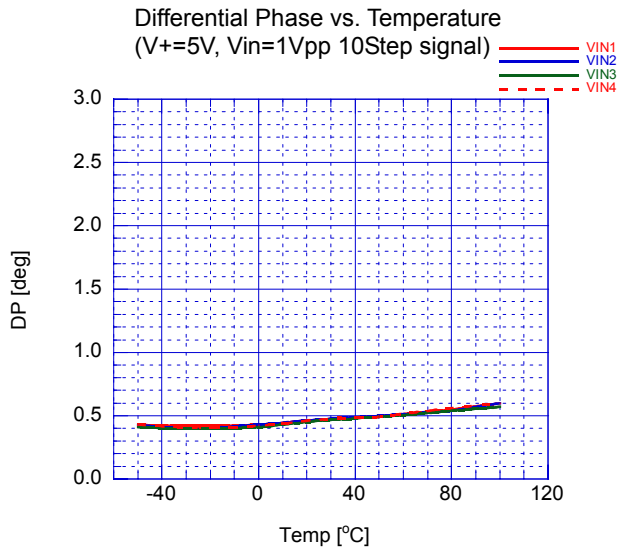

[CAUTION]  
The specifications on this databook are only given for information, without any guarantee as regards either mistakes or omissions. The application circuits in this databook are described only to show representative usages of the product and not intended for the guarantee or permission of any right including the industrial rights.