

VIDEO DIFFERENTIAL OUTPUT DRIVER

■GENERAL DESCRIPTION

The NJM2504 is video differential output driver. The single-end signal is converted to the differential signal. The single-end signal can be transmitted by the differential signal by the connection with NJM2507.

And, it is converted to the single-end signal by the NJM2507.

The common mode noise can be removed because of the differential motion transmission, and it is the best for the transmission of car AV system.

■PACKAGE OUTLINE



NJM2504RB1
MSOP8(TVSP8)

■FEATURES

- Operating Voltage 4.5 to 9.5V
 - Input: Single-end signal, Output: Differential signal
 - Internal 6dB Amplifier
 - Internal 75ohm Driver
 - Internal SAG Correction Circuit
 - Bipolar Technology
 - Package Outline MSOP8(TVSP8)*
- *MEET JEDEC MO-187-DA / THIN TYPE

■PIN CONNECTION

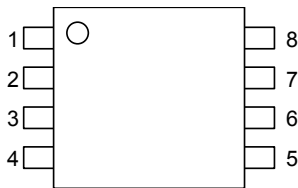

- 1: V+
- 2: Power Save
- 3: VIN
- 4: GND
- 5: Vsagn
- 6: Voutn
- 7: Vsagp
- 8: Voutp

■BLOCK DIAGRAM

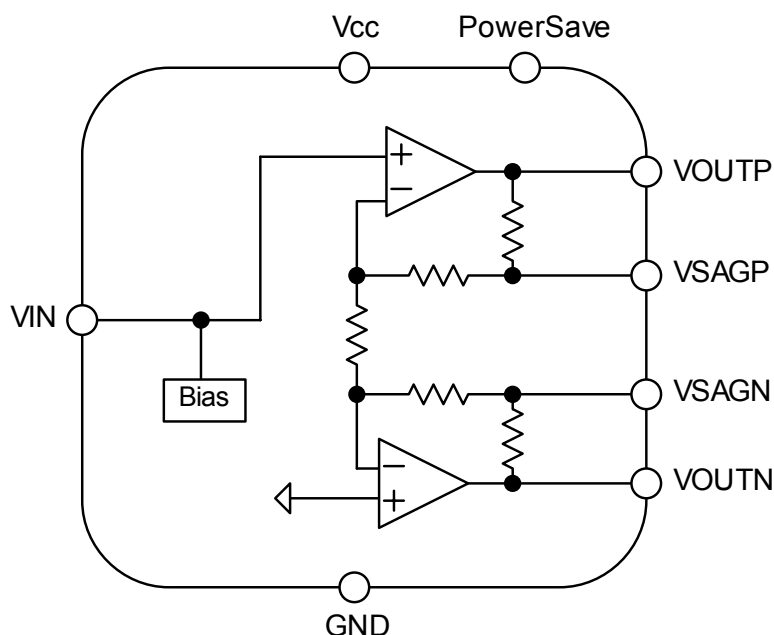

NJM2504

■ABSOLUTE MAXIMUM RATINGS (Ta=25°C)

PARAMETER	SYMBOL	RATINGS	UNIT
Supply Voltage	V ⁺	10	V
Power Dissipation	P _D	580(Note1)	mW
Operating Temperature Range	Topr	-40 to +85(Note2)	°C
Storage Temperature Range	Tstg	-40 to +150	°C

(Note 1) At on a board of EIA/JEDEC specification. (114.3 x 76.2 x 1.6mm 2 layers, FR-4)

(Note 2) It has high operating temperature range product. (-40 to +105°C)

■RECCOMENDED OPERATING CONDITIONS (Ta=25°C)

PARAMETER	SYMBOL	TEST CONDITION	MIN.	TYP.	MAX.	UNIT
Operating voltage	Vopr		4.5	-	9.0	V

■ELECTRICAL CHRACTERISTCS (V⁺=5V, RL=150ohm, Ta=25°C)

PARAMETER	SYMBOL	TEST CONDITION	MIN.	TYP.	MAX.	UNIT
Supply Current	I _{CC}	No signal	-	16	20	mA
Supply Current at Power Save Mode	I _{save}	Power save mode	-	0.3	0.5	mA
Maximum Output Level	V _{om}	Vin=100kHz, sin-signal, THD=1%,	2.2	2.4	-	Vp-p
Voltage Gain	G _v	Vin=1MHz, 1.0Vp-p sin-signal	5.7	6.2	6.7	dB
Frequency Characteristics	G _f	Vin=10MHz/1MHz, 1.0Vpp sin-signal	-1.0	0	1.0	dB
Differential Gain	DG	Vin=1.0Vp-p 10step video signal	-	0.5	-	%
Differential Phase	DP	Vin=1.0Vp-p 10step video signal	-	0.5	-	deg
SW Voltage High Level	V _{thH}		2.2	-	V ⁺	V
SW Voltage Low Level	V _{thL}		0	-	1.0	V
SW Sink Current High Level	I _{thH}	V=5V	-	-	120	μA
SW Sink Current Low Level	I _{thL}	V=0.3V	-	-	8.0	μA

■CONTROL CHRACTERISTIC

PARAMETER	STATUS	MODE	
Power Save	H	Power save: OFF	Active mode
	L	Power save: ON	Non-Active mode (Mute)
	OPEN	Power save: ON	Non-Active mode (Mute)

TEST CIRCUIT

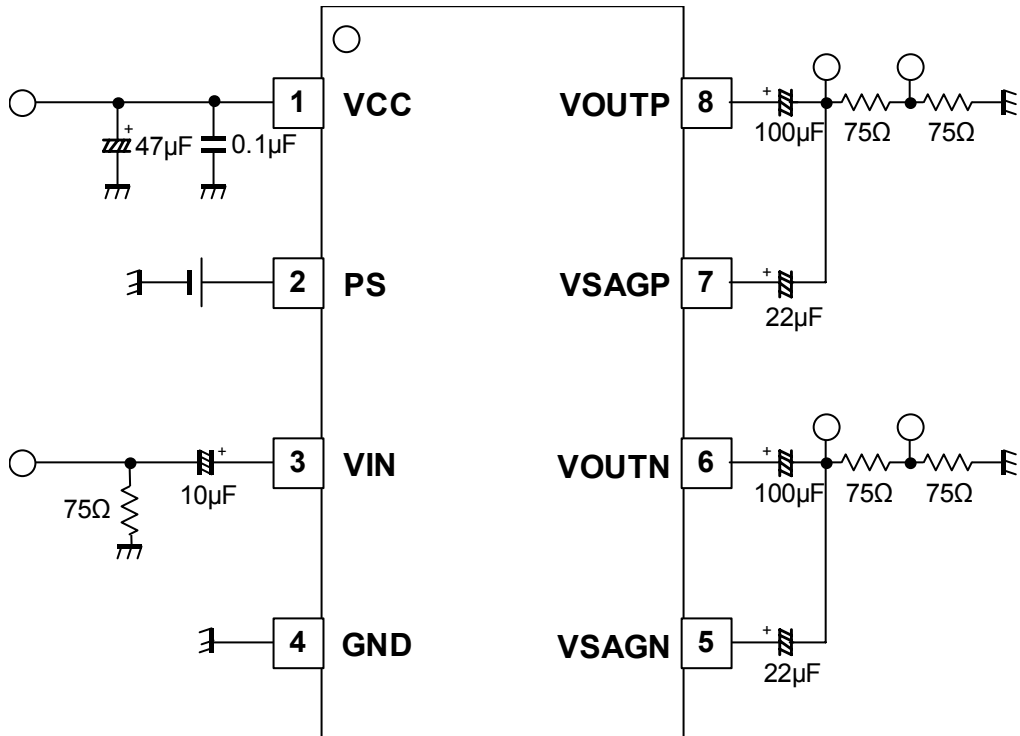

APPLICATION CIRCUIT

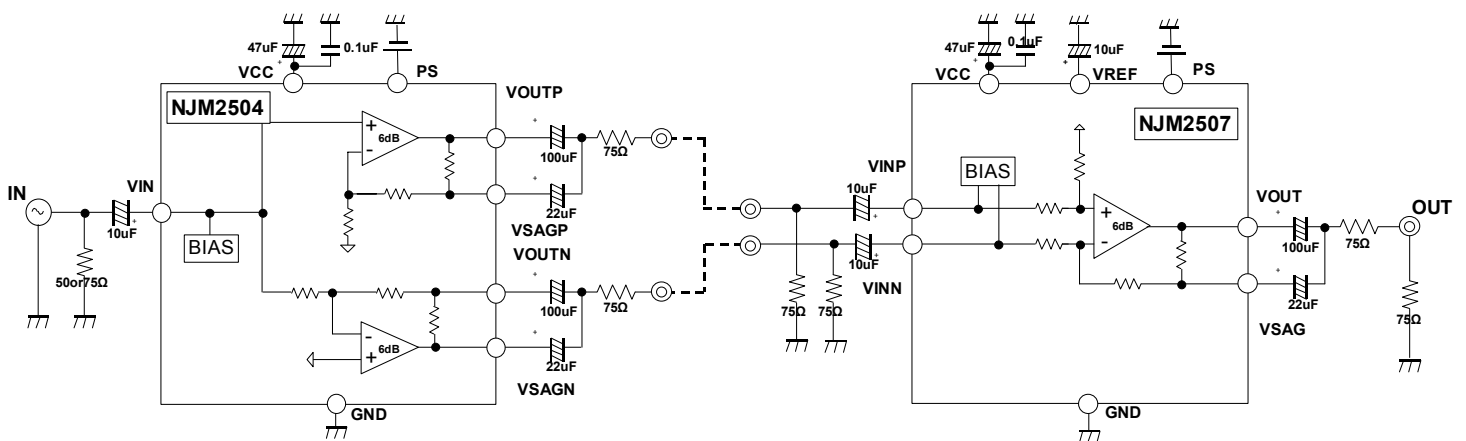

APPLICATION

When use cable of than 20 meter, voltage gain is attenuated. Please make a adequate evaluation. Refer to fig.

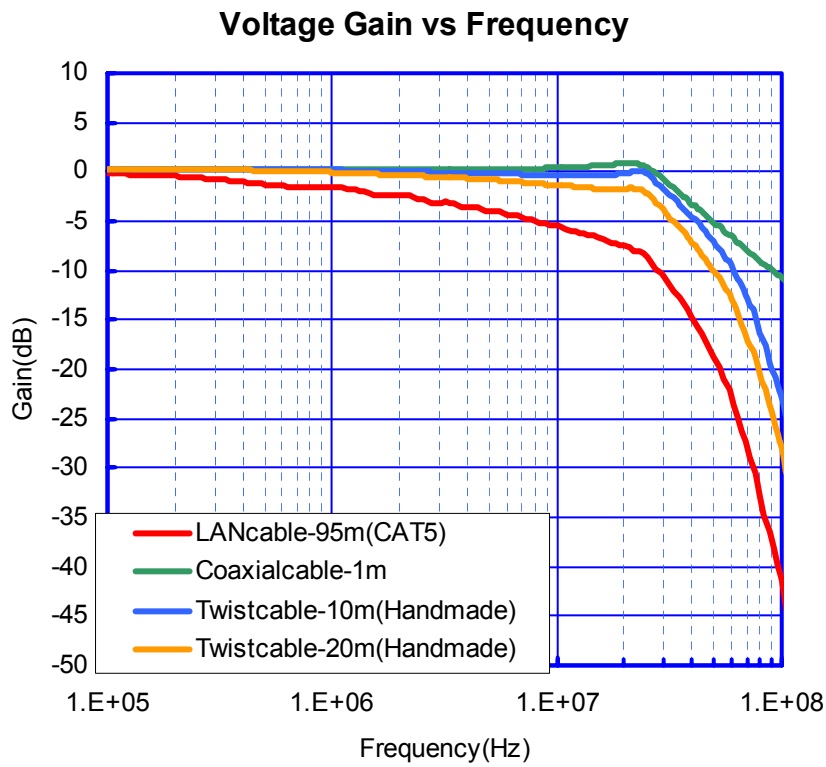

■ EQUIVALENT CIRCUIT (V_{cc}=5V)

PIN No.	PIN NAME	EQUIVALENT CIRCUIT	DC VOLTAGE
1	V _{cc}		5V
2	Power Save		-
3	V _{IN}		2.5V
4	GND		-
5	V _{SAGN}		2.5V
6 8	V _{OUTN} V _{OUTP}		2.5V
7	V _{SAGP}		2.5V

NJM2504

TYPICAL CHARACTERISTICS

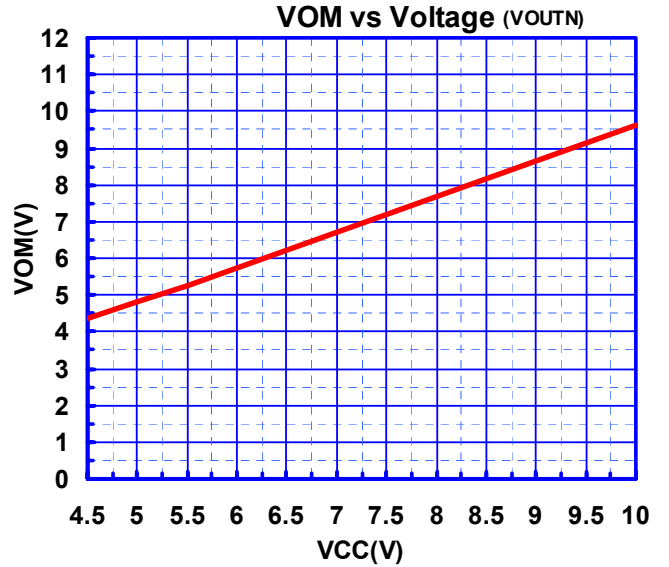
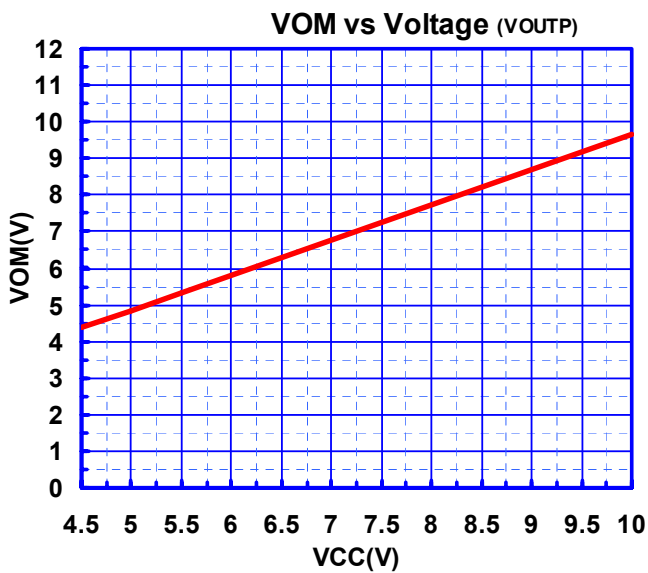
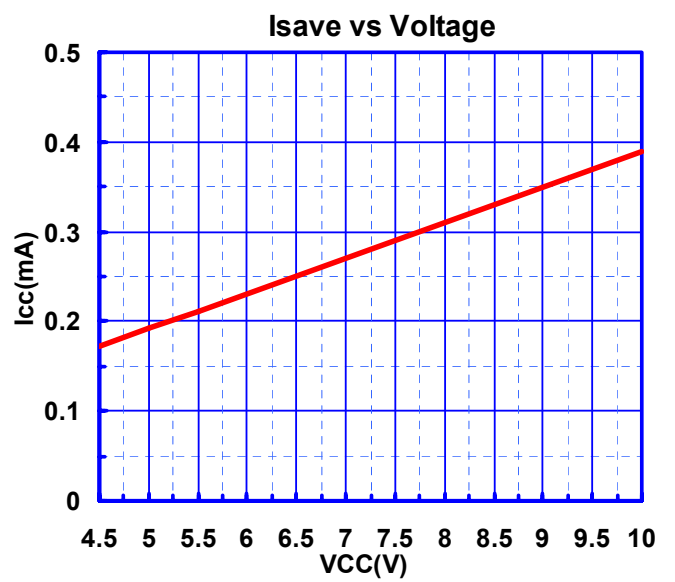
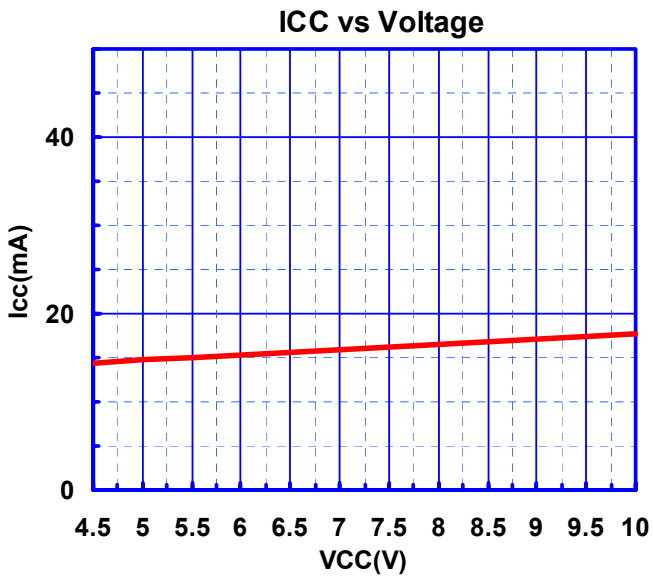
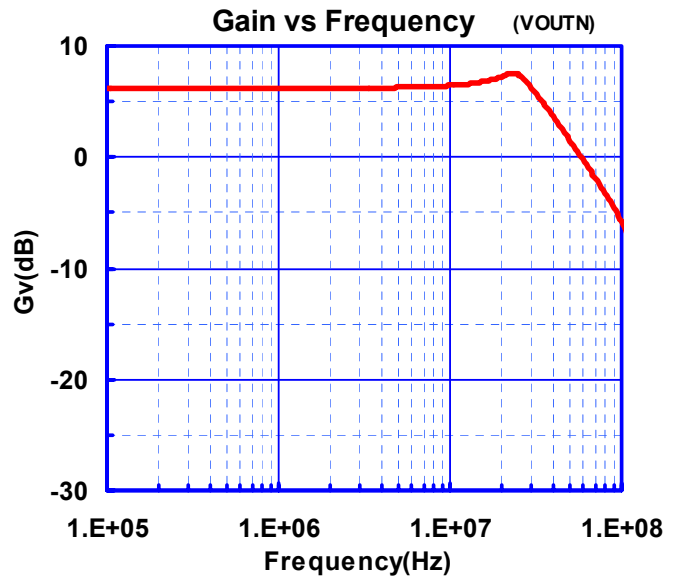
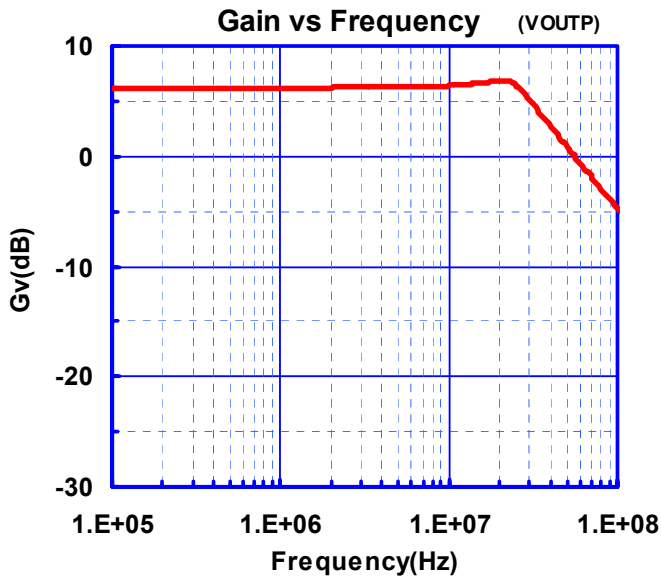

Ver

New Japan Radio Co., Ltd.

TYPICAL CHARACTERISTICS

Gv vs Voltage (VOUTP)

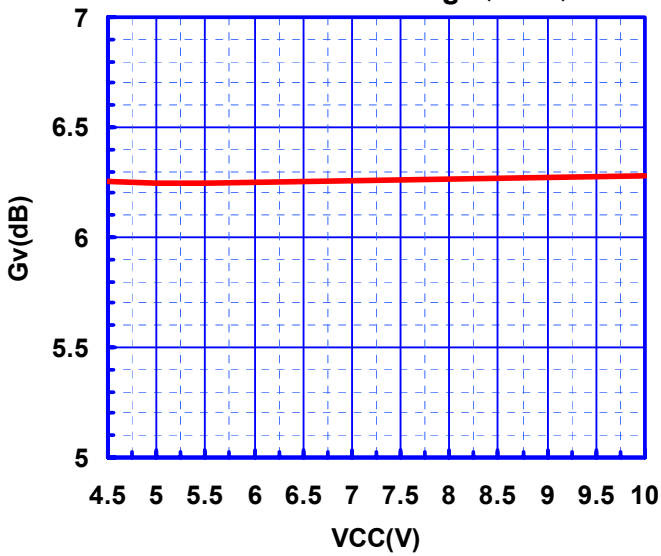

Gv vs Voltage (VOUTN)

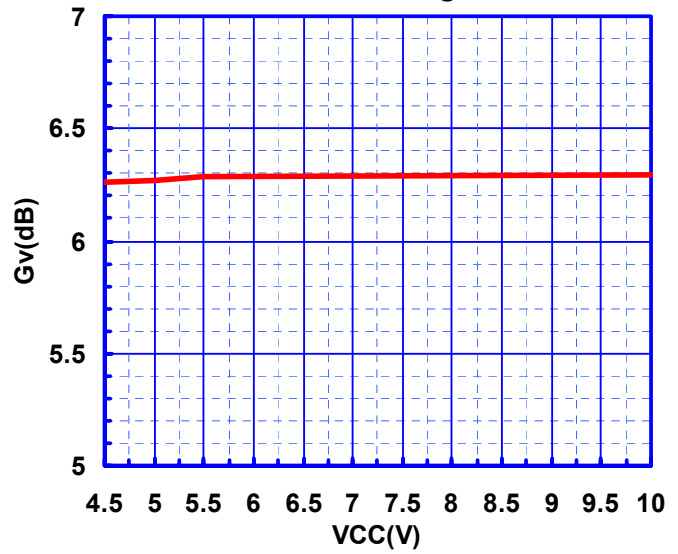

Gf vs Voltage (VOUTP)

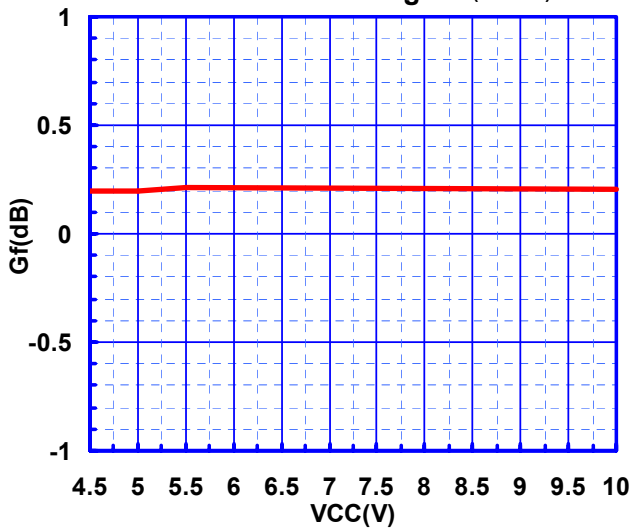

Gf vs Voltage (VOUTN)

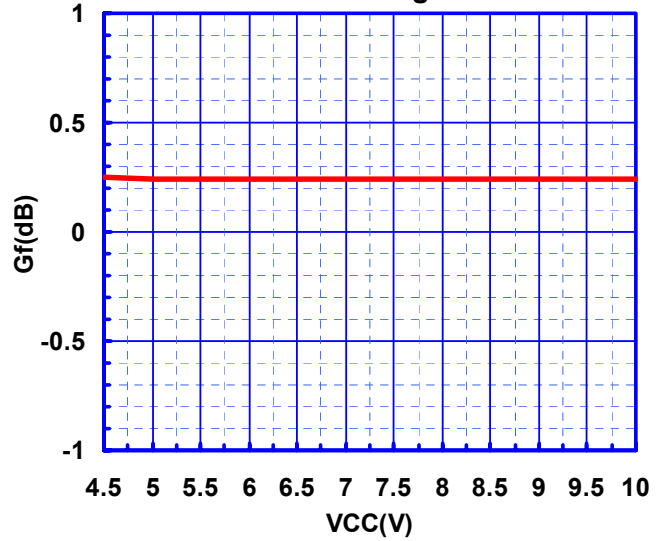

DG vs Voltage (VOUTP)

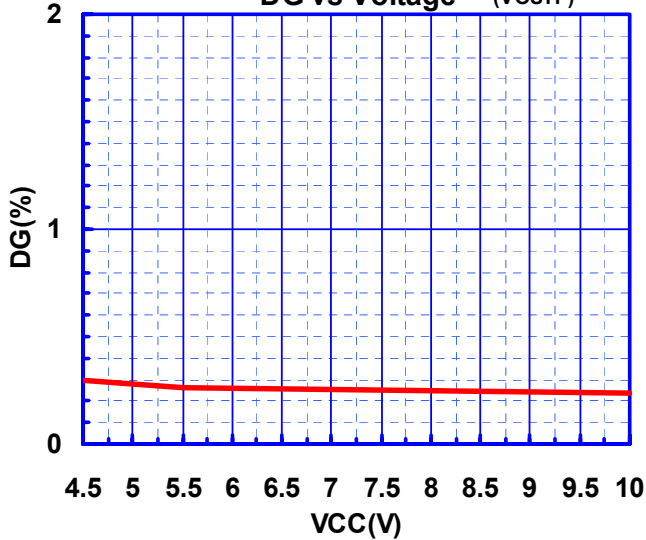

DG vs Voltage (VOUTN)

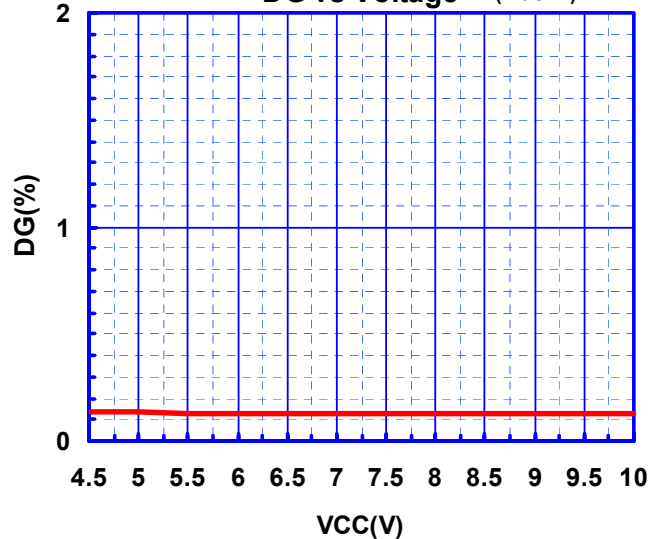

NJM2504

TYPICAL CHARACTERISTICS

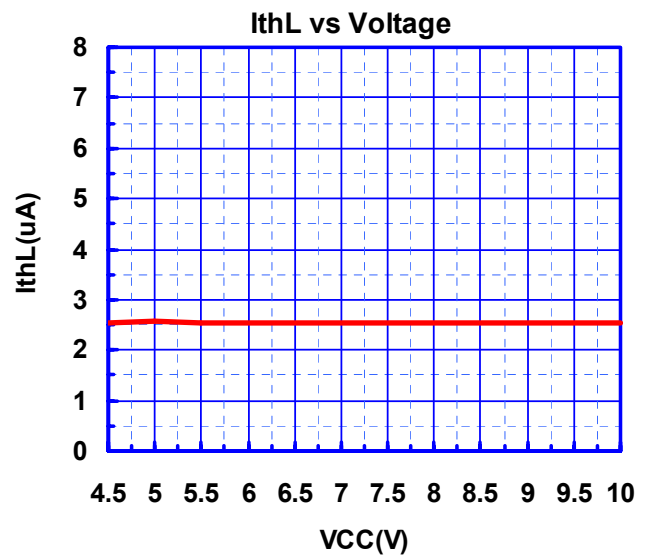
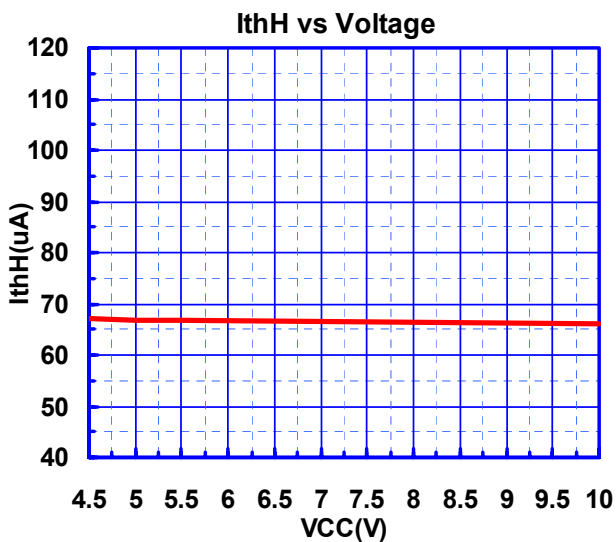
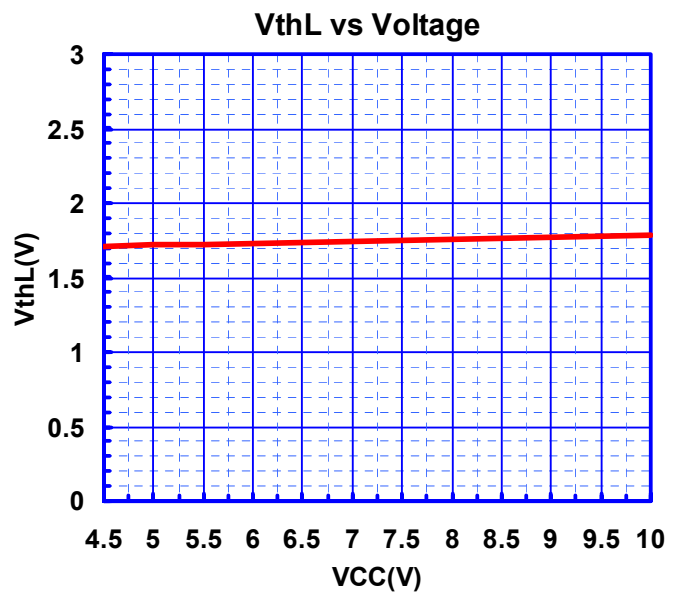
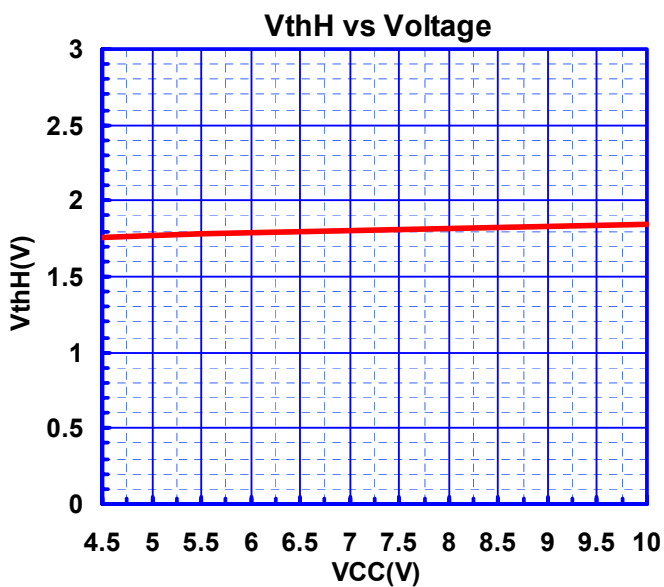
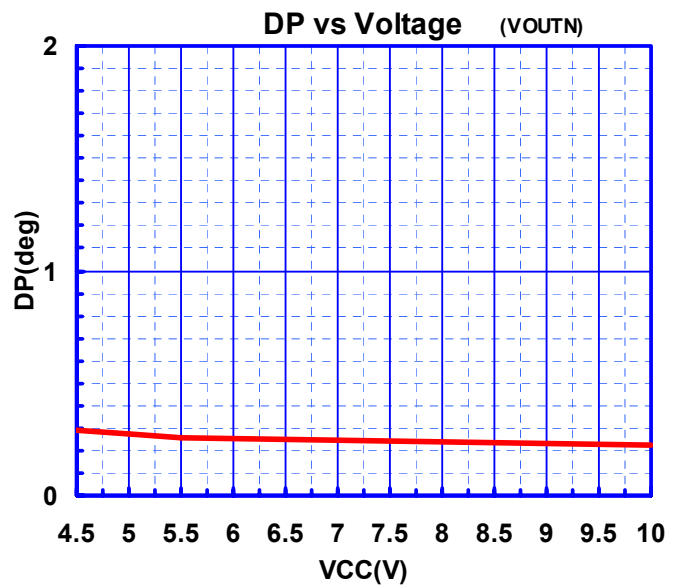
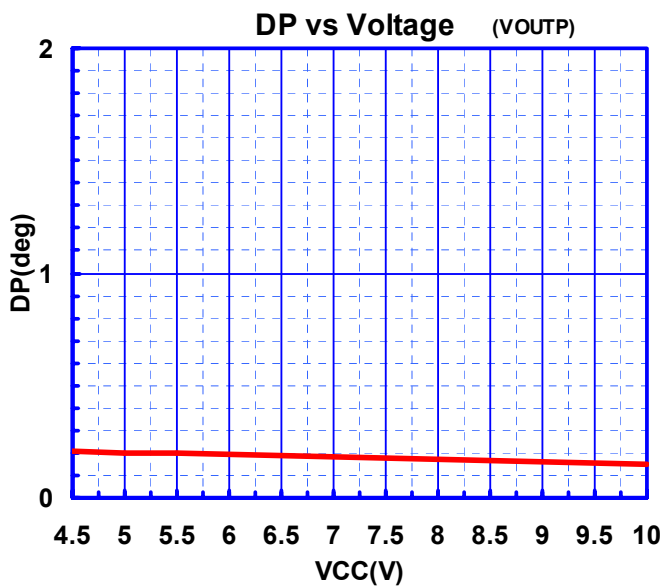

TYPICAL CHARACTERISTICS

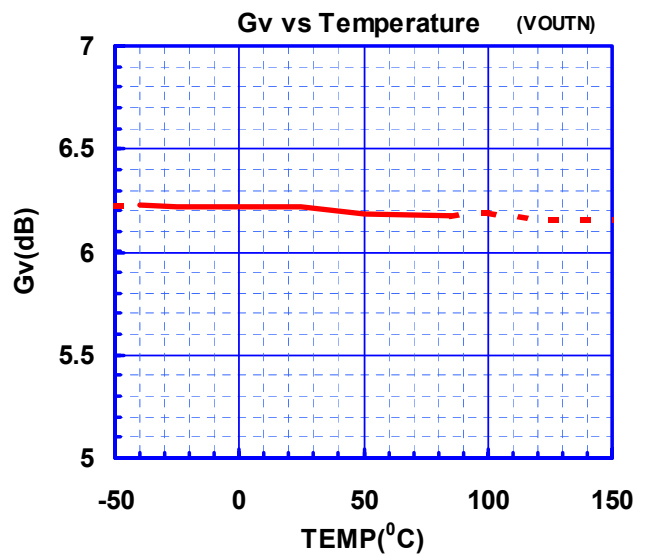
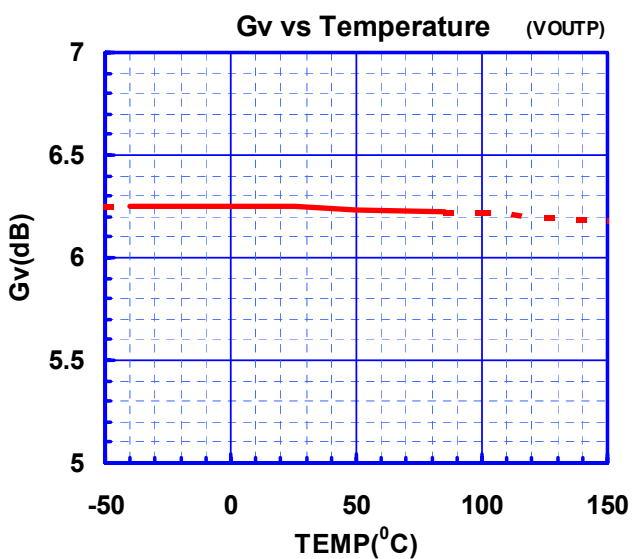
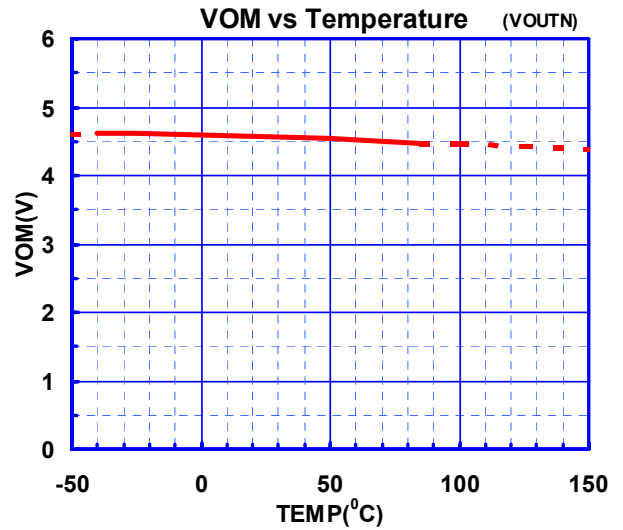
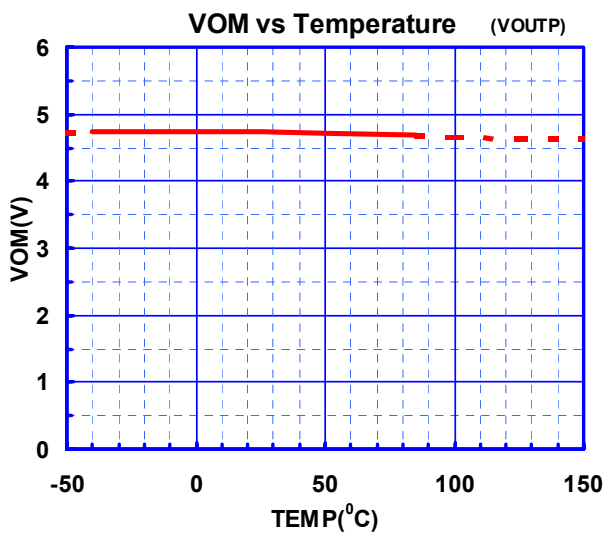
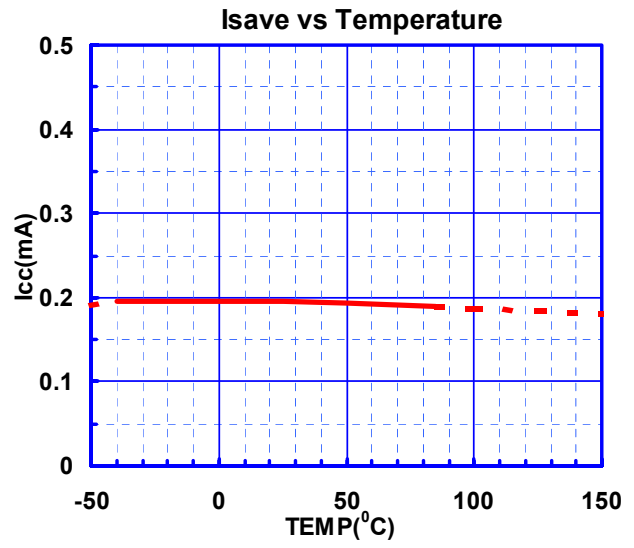
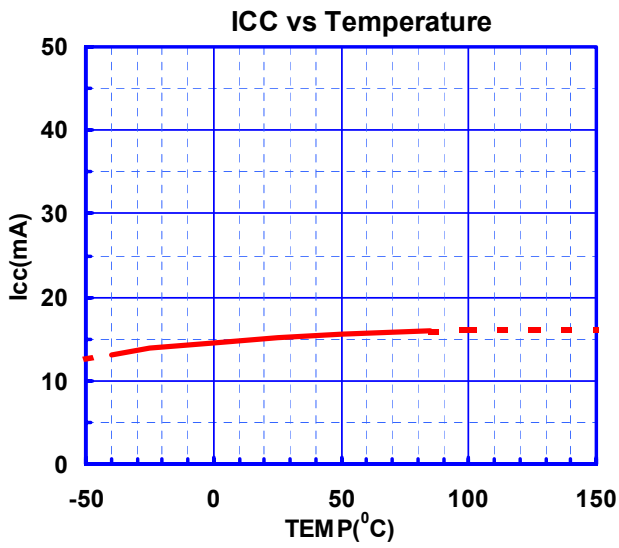

NJM2504

TYPICAL CHARACTERISTICS

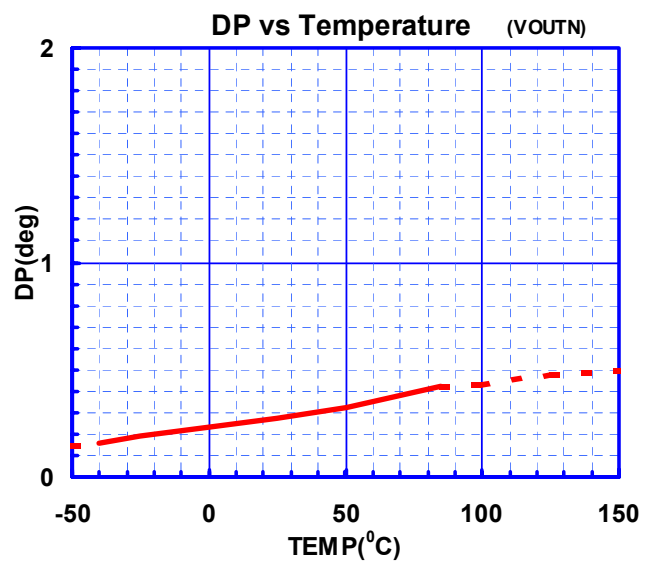
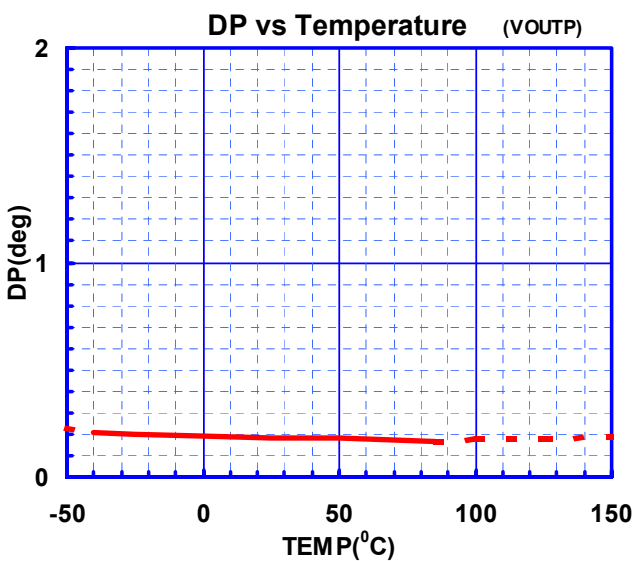
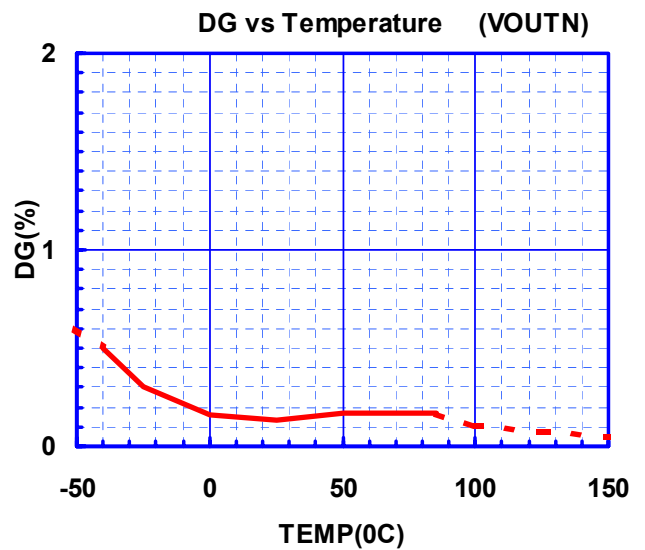
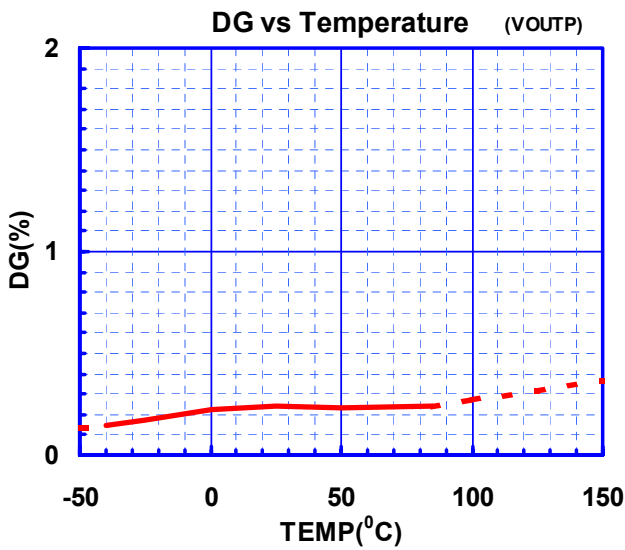
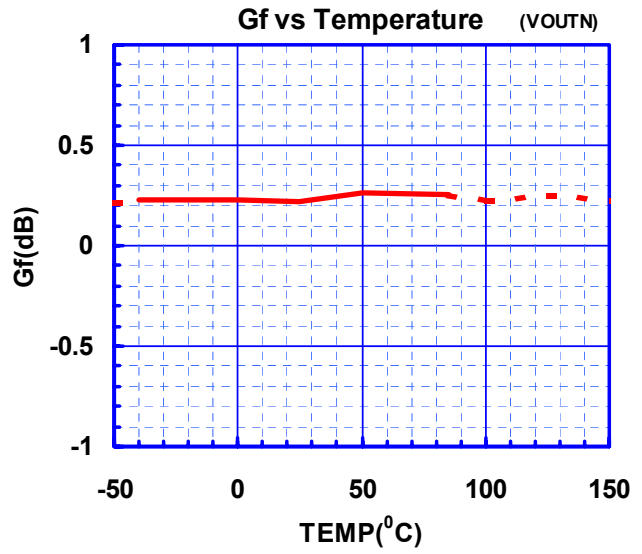
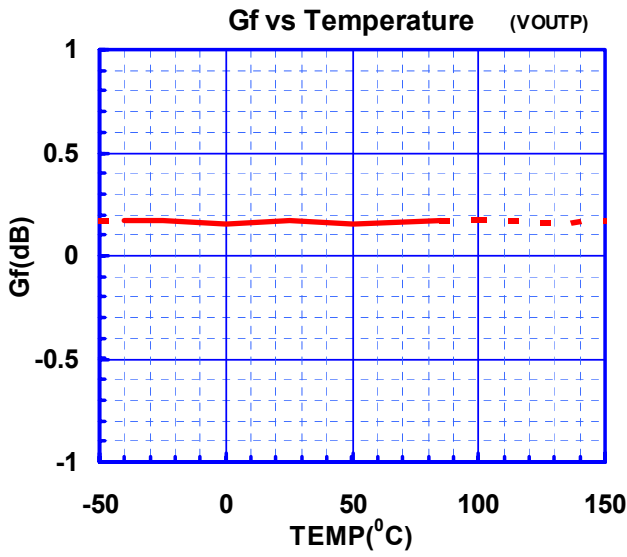

TYPICAL CHARACTERISTICS

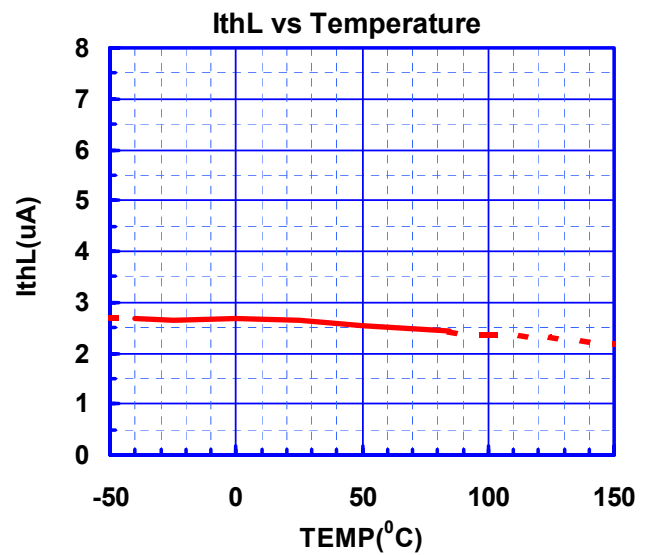
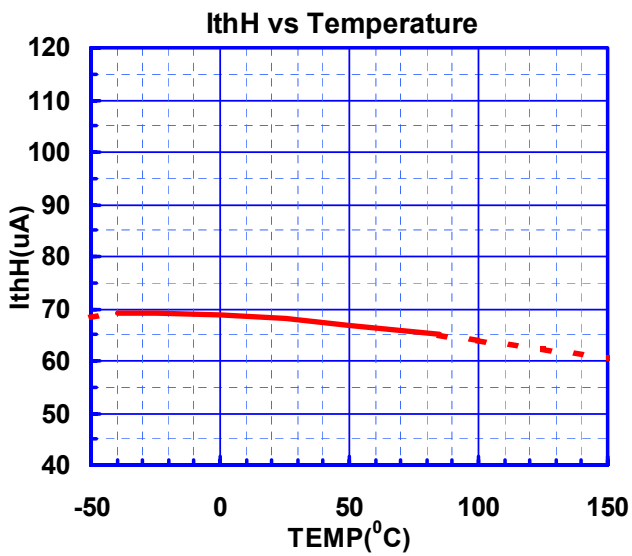
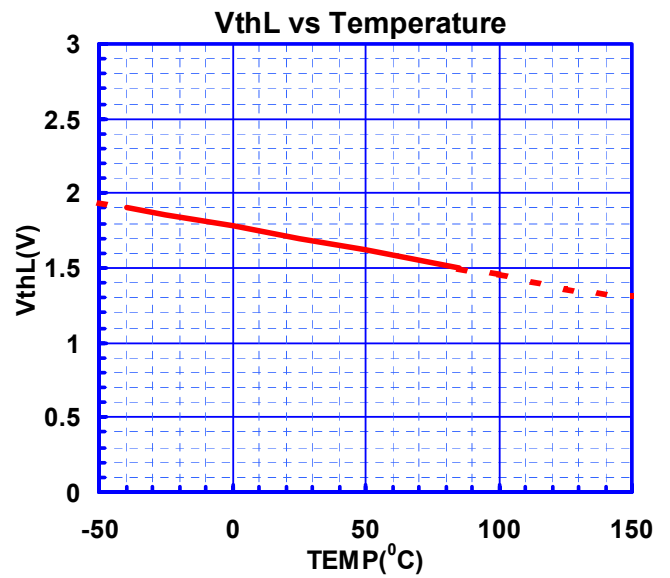
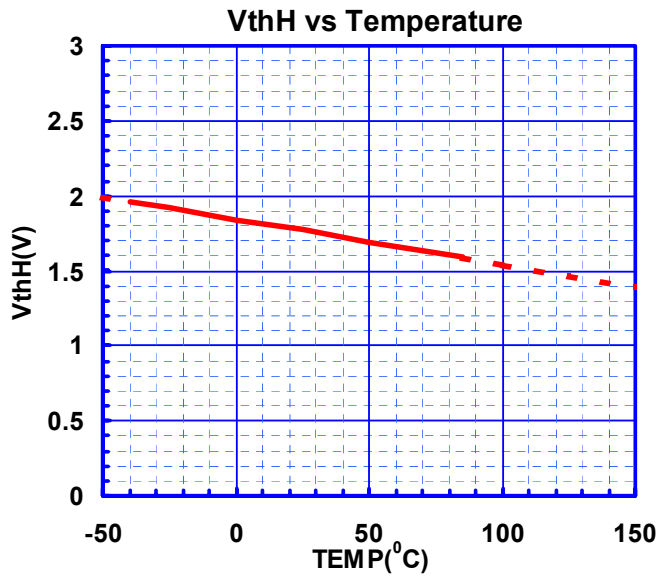

[CAUTION]

The specifications on this databook are only given for information, without any guarantee as regards either mistakes or omissions. The application circuits in this databook are described only to show representative usages of the product and not intended for the guarantee or permission of any right including the industrial rights.