

Step-Down PWM DC/DC Converter IC

■GENERAL DESCRIPTION

The NJM2393 is a step down PWM DC/DC converter IC. An internal 1.5A power transistor, a pulse-by-pulse current limit circuit and a 1% precision reference make the NJM2393 suitable for a wide range of step down applications. The NJM2393 features 100% maximum duty cycle for low voltage drop operation.

■PACKAGE OUTLINE

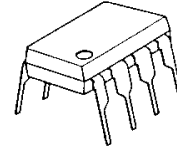

NJM2393D

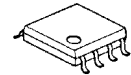

NJM2393M

■FEATURES

- Operating Voltage 3.0V~40V
- Wide Oscillator Frequency 1kHz~150kHz
- Precision Reference Voltage $V_{th}=1.25V \pm 1\%$
- Internal High Power Transistor 1.5A max.
- Maximum duty ratio 100%
- Internal Over Current Limit Circuit
- PWM switching control
- Bipolar Technology
- Package Outline NJM2393D : DIP8
NJM2393M : DMP8

■PIN CONFIGURATION

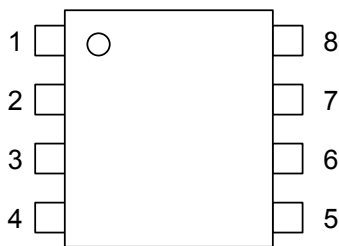

NJM2393D
NJM2393M

PIN FUNCTION

1. C_S
2. E_S
3. C_T
4. GND
5. IN-
6. V^+
7. S_I
8. C_D

■BLOCK DIAGRAM

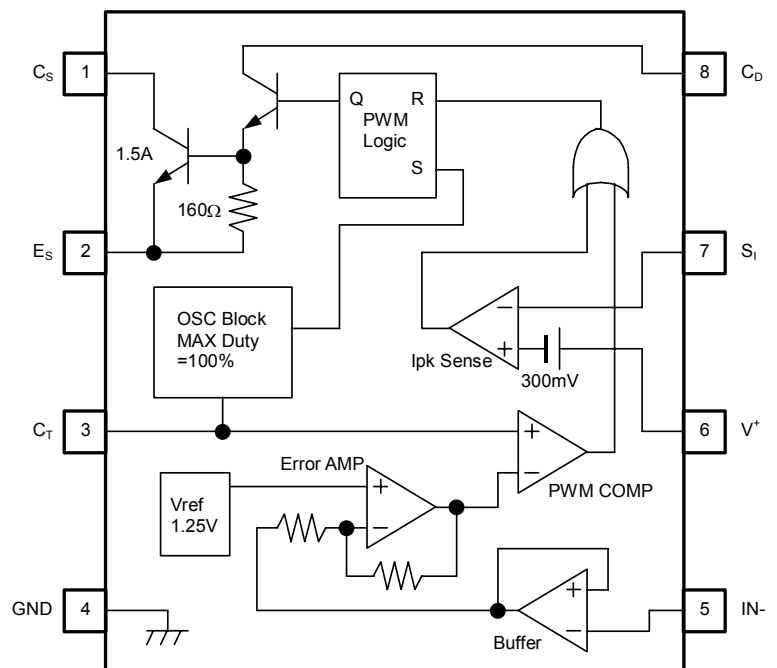

NJM2393

■ABSOLUTE MAXIMUM RATINGS (Ta=25°C)

PARAMETER	SYMBOL	MAXIMUM RATINGS	UNIT
Maximum Supply Voltage	V ⁺	40	V
Comparator Input Voltage	V _{IR}	-0.3 ~ 40 (note)	V
Output Driver Voltage	V _{C(driver)}	40	V
Output Switch Voltage	V _{SW}	40	V
Output Driver Current	I _{C(driver)}	100	mA
Output Switch Current	I _{SW}	1.5	A
Power Dissipation	P _D	DIP8 875 DMP8 580 (*1) 750 (*2)	mW
Operating Temperature Range	Topr	-40 ~ +85	°C
Storage Temperature Range	Tstg	-50 ~ +150	°C

(note) When supply voltage is less than 40V, the absolute maximum input voltage is equal to the supply voltage.

(*1) At on PC board : 114.3mm × 76.2mm × 1.6mm(2 layer FR-4) : Conform to EIA/JEDEC

(*2) At on PC board :114.3mm × 76.2mm × 1.6mm(4 layer FR-4) : Conform to EIA/JEDEC

■POWER DISSIPATION vs. AMBIENT TEMPERATURE

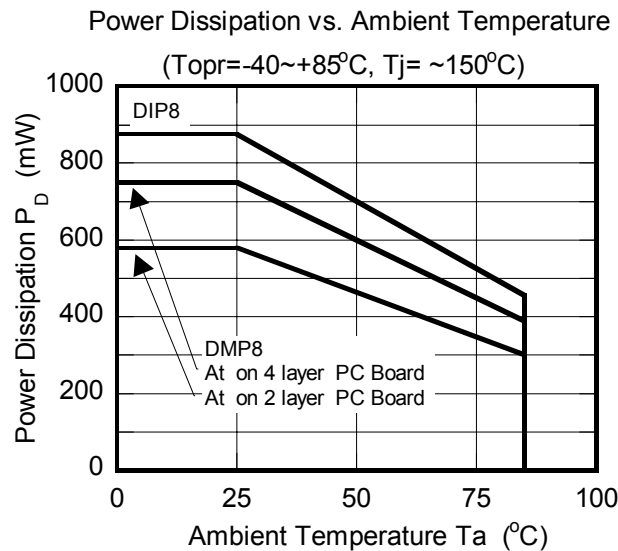

■ ELECTRICAL CHARACTERISTICS

DC Characteristics ($V^+=5V$, $T_a=25^\circ C$)

PARAMETER	SYMBOL	TEST CONDITIONS	MIN.	TYP.	MAX.	UNIT
-----------	--------	-----------------	------	------	------	------

OSCILLATOR BLOCK

Oscillation Frequency	f_{OSC}	IN= V_{th} -5mV, $C_T=1nF$	18	27	36	kHz
Charge Current	I_{chg}		11	18	27	μA
Discharge Current	I_{dis}		110	180	300	μA
Voltage Swing	V_{OSC}	$C_T=1nF$	-	0.5	-	V_{P-P}

CURRENT LIMIT

Peak Current Sense Voltage	V_{ipk}		250	300	350	mV
----------------------------	-----------	--	-----	-----	-----	----

OUTPUT SWITCH

Saturation Voltage 1	V_{sat1}	Darlington Connection ($C_S=C_D$), $I_{SW}=0.7A$	-	1.0	1.3	V
Saturation Voltage 2	V_{sat2}	$I_{SW}=0.7A$, $I_C(\text{driver})=50mA$ (Forced $\beta \approx 14$)	-	0.5	0.7	V
Saturation Voltage 3	V_{sat3}	$I_{SW}=3mA$, $I_C(\text{driver})=5mA$	-	-	0.3	V
Output Transistor Bias Resistance	R_{bias}		-	160	-	Ω
DC Voltage Gain	h_{FE}	$I_{SW}=0.7A$, $V_{CE}=5.0V$	35	120	-	-
Collector Off-State Current	$I_{C(Off)}$	$V_{CE}=40V$	-	0.01	1	μA
Maximum duty ratio	$M_{AX}D_{UTY}$	IN=0V	100	-	-	%

ERROR AMPLIFIER

Threshold Voltage	V_{th}		1.2375	1.250	1.2625	V
Input Bias Current	I_{IB}	IN= V_{th}	-	100	200	nA

GENERAL CHARACTERISTICS

Operating Current	I_{CC}	$C_T=1nF$, $S_I=V^+$, IN-> V_{th} , $E_S=GND$	-	2.8	4.0	mA
-------------------	----------	---	---	-----	-----	----

(note) Output switch tests are performed under pulsed conditions to minimize power dissipation.

NJM2393

■TYPICAL APPLICATIONS

Step-Down Converter

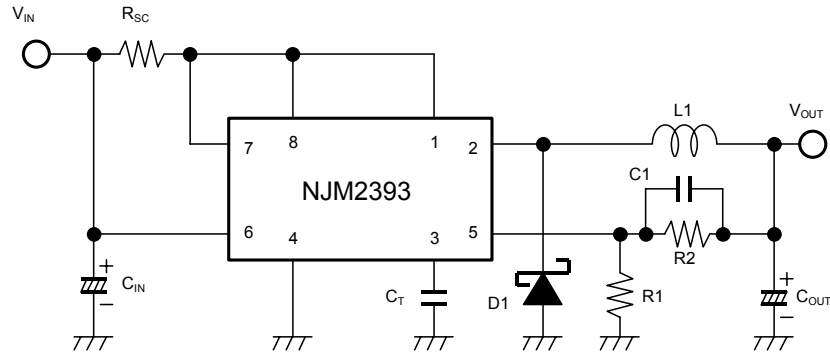

Step-Down Converter (High Current)

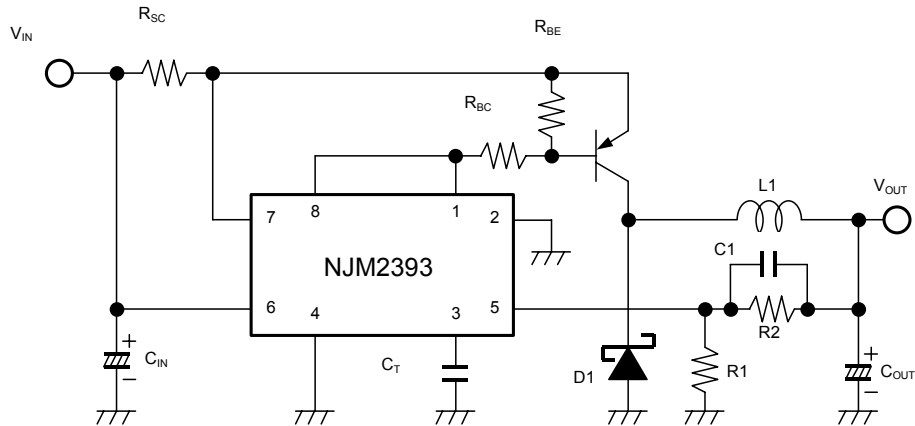

D1 use to schottky diode.

■TIMING CHART

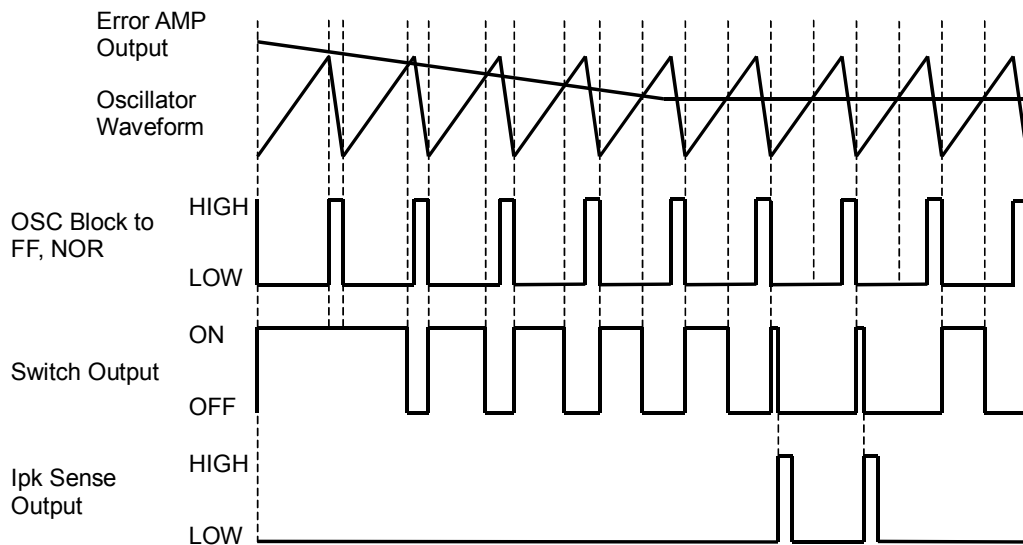

■ TYPICAL CHARACTERISTICS

Oscillator Frequency vs. Timing Capacitor

($V^+ = 5V$, $S_I = V^+$, Pin 5 = GND, $T_a = 25^\circ C$)

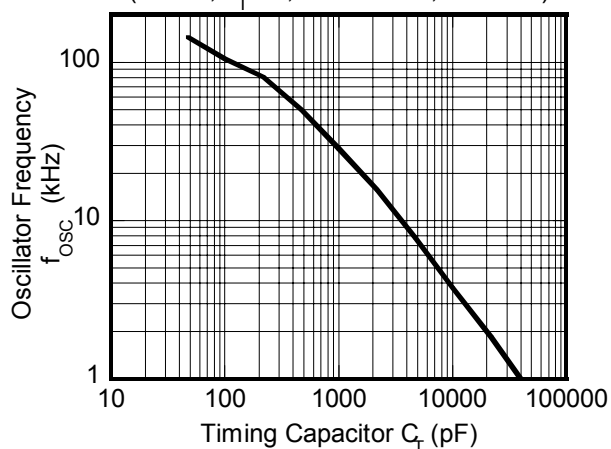

Saturation Voltage 1 vs. Collector Current

($V^+ = 5V$, $C_S = C_D$, $T_a = 25^\circ C$)

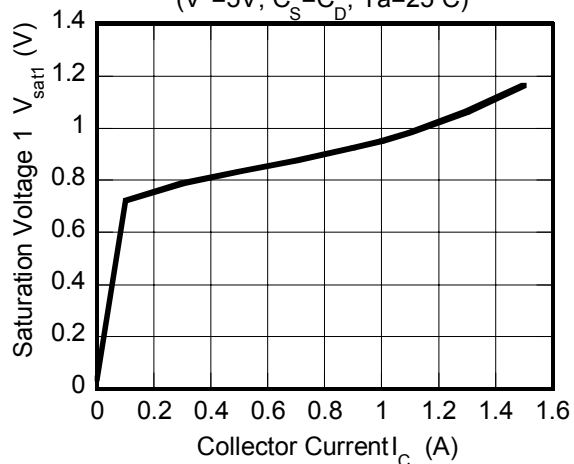

Saturation Voltage 2 vs. Collector Current

($V^+ = 5V$, $I_C(\text{driver}) = 50mA$, $\beta \approx 14$, $T_a = 25^\circ C$)

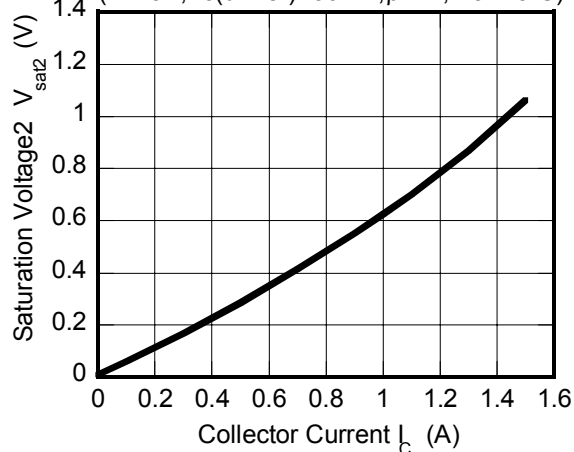

Saturation Voltage 3 vs. Collector Current

($V^+ = 5V$, $I_C(\text{driver}) = 5mA$, $T_a = 25^\circ C$)

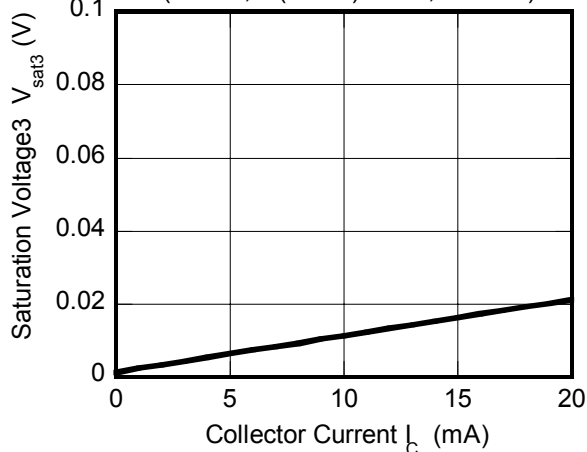

Input Bias Current vs. IN- Terminal Voltage

($V^+ = 5V$, $T_a = 25^\circ C$)

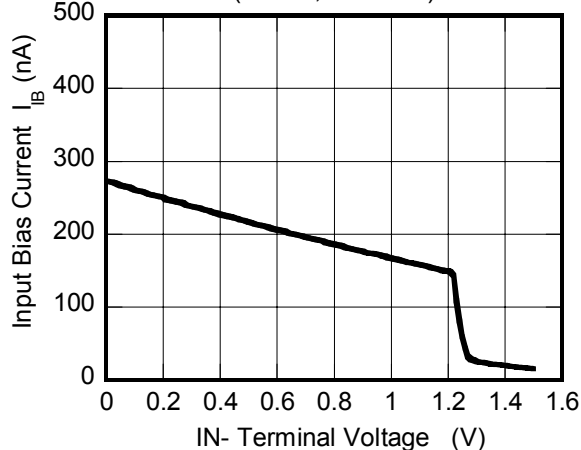

Operating Current vs. Operating Voltage

($C_T = 1nF$, $S_I = V^+$, $IN \rightarrow V_{th}$, $Es = GND$, $T_a = 25^\circ C$)

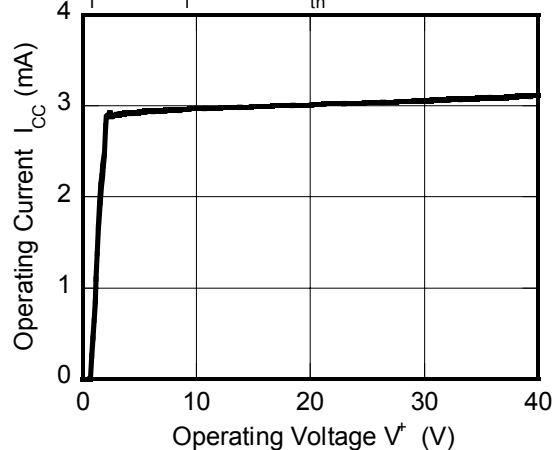

■ TYPICAL CHARACTERISTICS

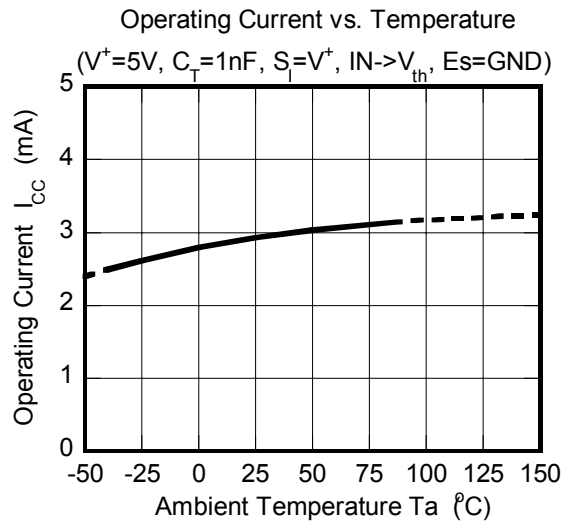
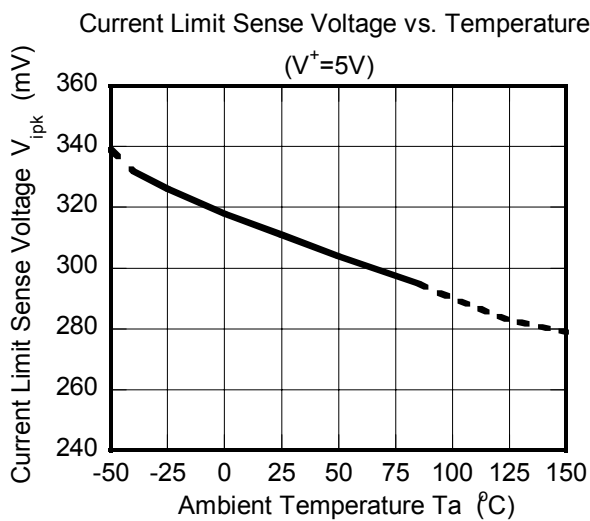
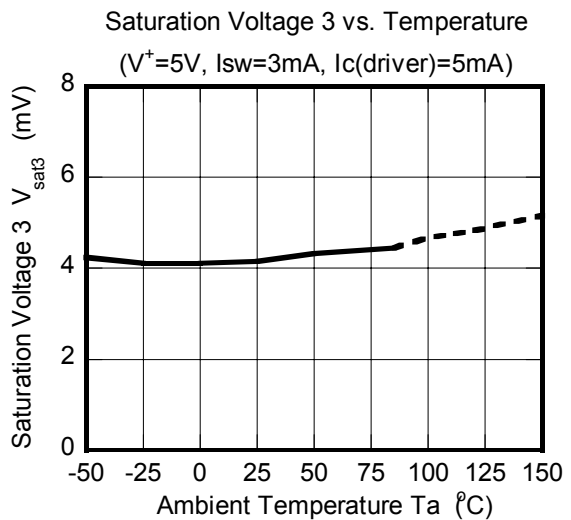
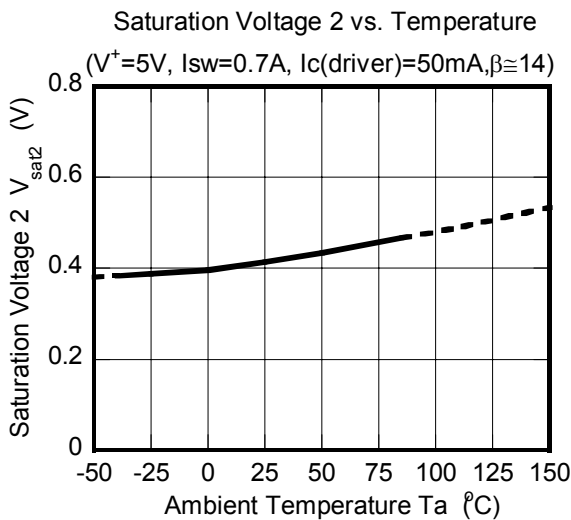
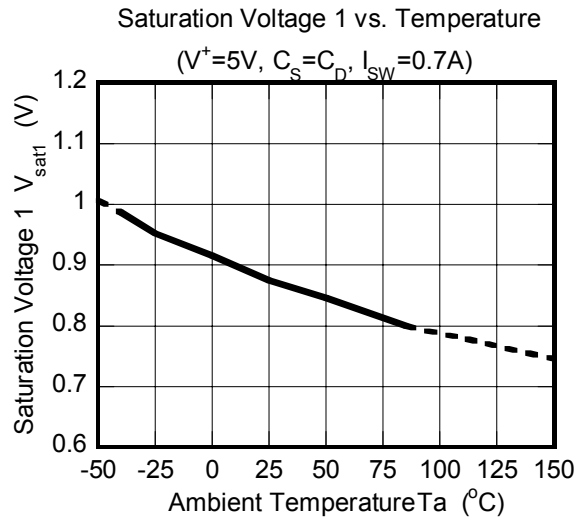
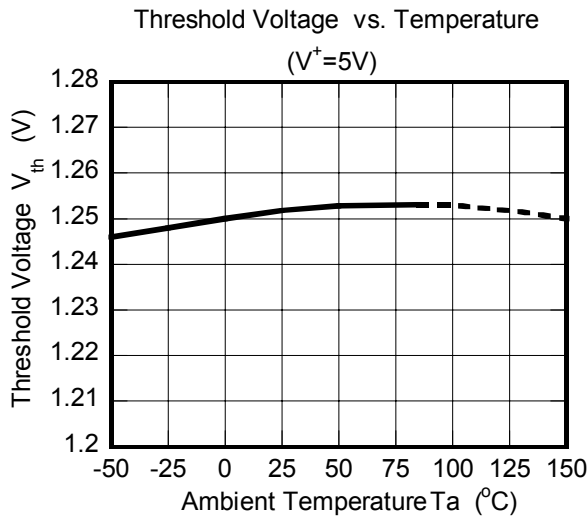

MEMO

CAUTION]
The specifications on this databook are only given for information, without any guarantee as regards either mistakes or omissions. The application circuits in this databook are described only to show representative usages of the product and not intended for the guarantee or permission of any right including the industrial rights.