

SINGLE SUPPLY DUAL OPERATIONAL AMPLIFIER

■ GENERAL DESCRIPTION

The NJM13404 is single-supply dual operational amplifier, which can operate from 2V supply. The features are low offset voltage, low bias current, high slew-rate, and free crossover distortion through the AB class output stage.

The package lineup is DIP, DMP and others compact, so that the NJM13404 is suitable for audio for low voltage operation and any other kind of signal amplifier.

■ FEATURES

- Operating Voltage +2V~+14V
- Slew Rate 1.2V/μs typ.
- Operating Current 2.0mA typ.
- Bipolar Technology
- Package Outline DIP8, SIP8, DMP8, SSOP8
SOP8 JEDEC 150mil
MSOP8 (VSP8)MEET JEDEC MO-187-DA
MSOP8 (TVSP8)MEET JEDEC MO-187-DA / thin type

■ PACKAGE OUTLINE

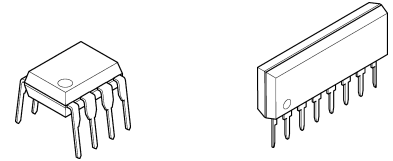

NJM13404D
(DIP8)

NJM13404L
(SIP8)



NJM13404M
(DMP8)



NJM13404E
(SOP8)



NJM13404V
(SSOP8)



NJM13404R
(MSOP8(VSP8))



NJM13404RB1
(MSOP8(TVSP8))

■ PIN CONFIGURATION

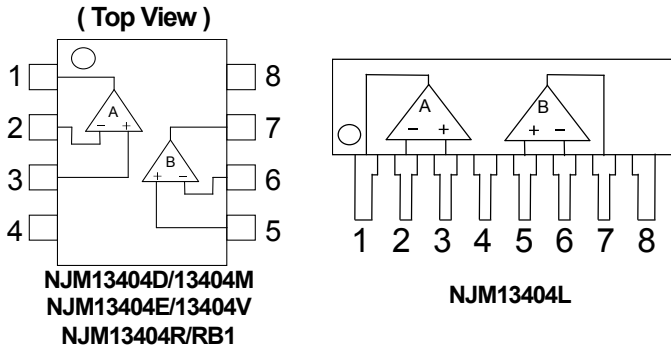

PIN FUNCTION

1. A OUTPUT
2. A-INPUT
3. A +INPUT
4. GND(V⁻)
5. B +INPUT
6. B-INPUT
7. B OUTPUT
8. V⁺

■ EQUIVALENT CIRCUIT (1/2 Shown)

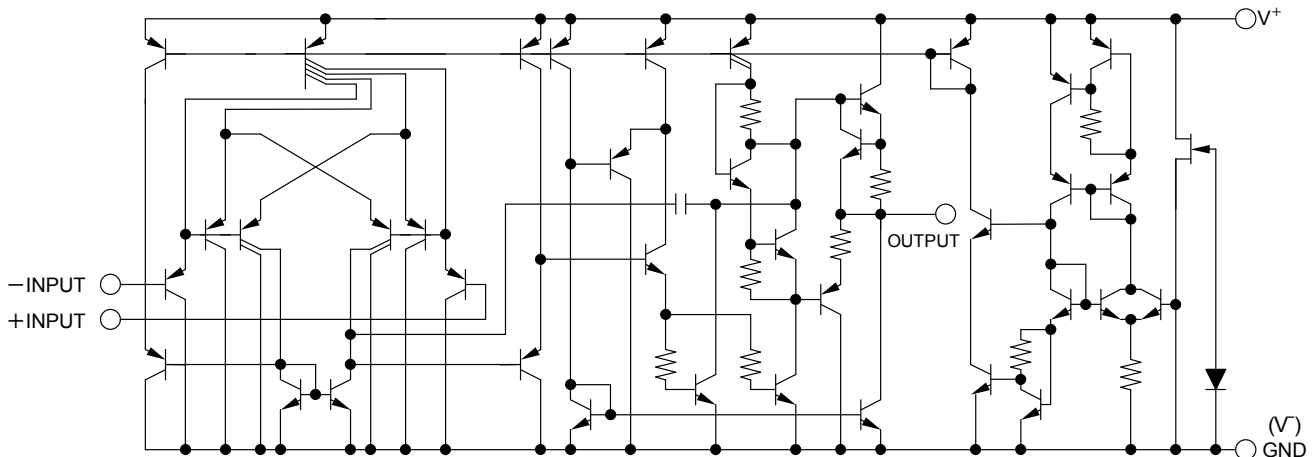

NJM13404

■ ABSOLUTE MAXIMUM RATINGS

(Ta=25°C)

PARAMETER	SYMBOL	RATINGS	UNIT
Supply Voltage	V^+	15	V
Differential Input Voltage	V_{ID}	14	V
Input Voltage	V_{IC}	-0.3~+14	V
Power Dissipation	P_D	(DIP8) 500 (DMP8) 300 (EMP8) 300 (SSOP8) 250 (MSOP8(VSP8)) 320 (MSOP8(TVSP8)) 320 (SIP8) 800	mW
Operating Temperature Range	T_{opr}	-40~+85	°C
Storage Temperature Range	T_{stg}	-40~+125	°C

■ ELECTRICAL CHARACTERISTICS

($V^+=5V, Ta=25°C$)

PARAMETER	SYMBOL	TEST CONDITION	MIN.	TYP.	MAX.	UNIT
Operating Voltage	V_{opr}		2	-	14	V
Input Offset Voltage	V_{IO}	$R_S=0\Omega$	-	0.5	4	mV
Input Offset Current	I_{IO}		-	5	50	nA
Input Bias Current	I_B		-	25	150	nA
Large Signal Voltage Gain	A_V	$R_L \geq 2k\Omega$	88	100	-	dB
Maximum Output Voltage Swing	V_{OM}	$R_L=2k\Omega$	4.0	4.2	-	V
Input Common Mode Voltage Range	V_{ICM}		0~3.5	-	-	V
Common Mode Rejection Ratio	CMR		70	90	-	dB
Supply Voltage Rejection Ratio	SVR		80	94	-	dB
Output Source Current	I_{SOURCE}	$V_{IN}^+=1V, V_{IN}^-=0V$	20	35	-	mA
Output Sink Current	I_{SINK}	$V_{IN}^+=0V, V_{IN}^-=1V$	10	30	-	mA
Operating Current	I_{CC}	$R_L=\infty$	-	2.0	3.5	mA
Slew Rate	SR	$V^+/V^-=\pm 2.5V, R_L=2k\Omega,$ $A_V=0dB, f=1kHz$	-	1.2	-	V/ μ s
Unity Gain Bandwidth	f_T	$R_L=2k\Omega$	-	2.0	-	MHz
Total Harmonic Distortion	THD	$R_L=2k\Omega, A_V=40dB,$ $f=20kHz, V_O=1V_{rms}$	-	0.2	-	%

■ TYPICAL CHARACTERISTICS

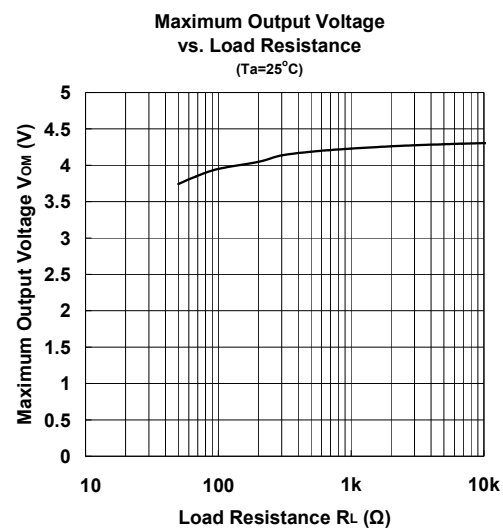
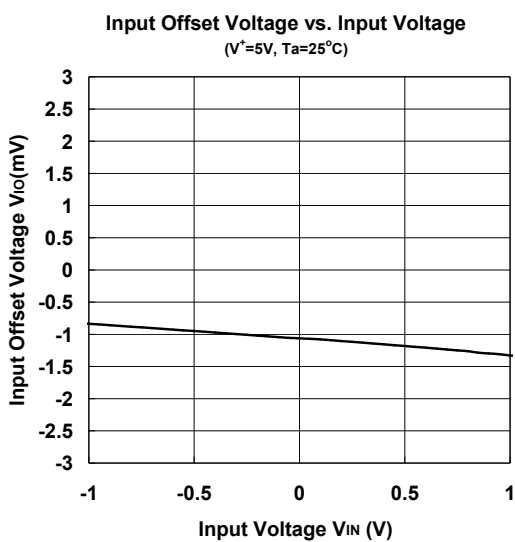
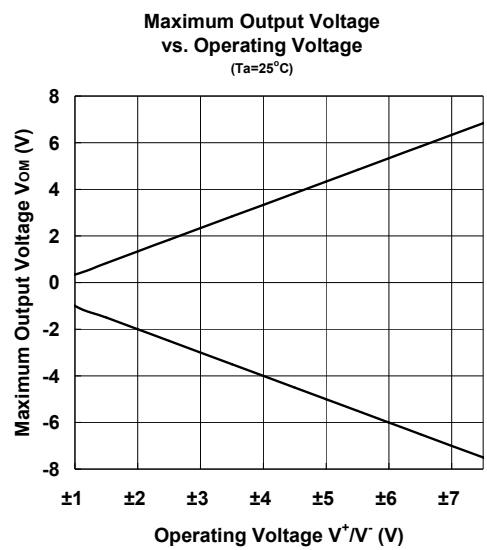
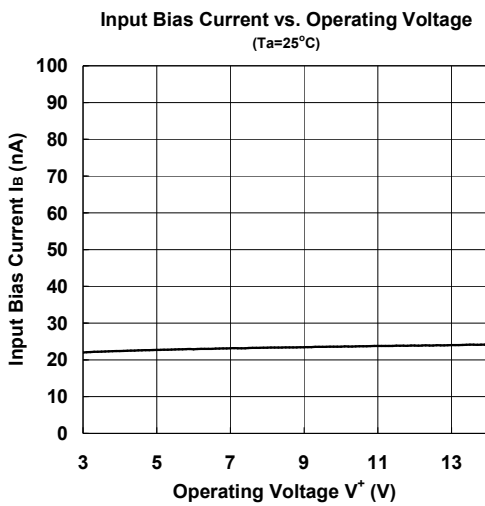
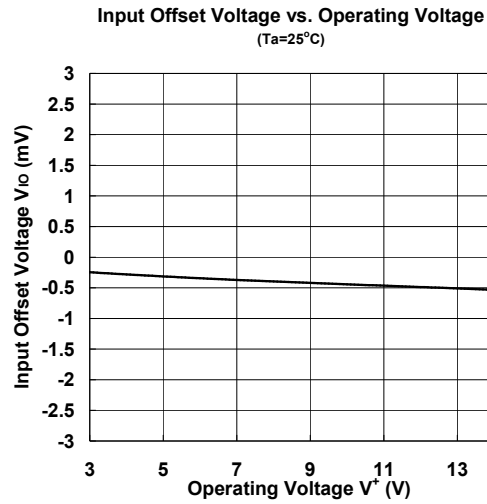
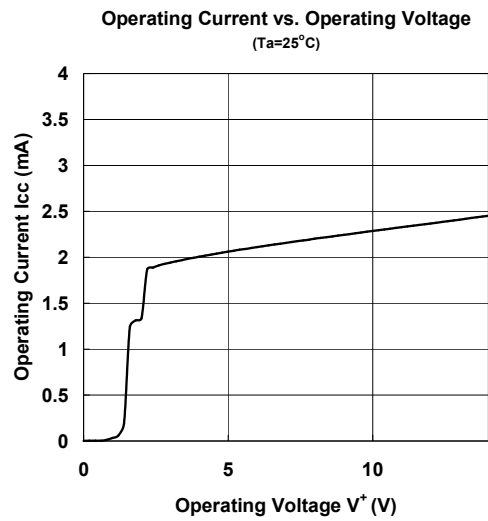

NJM13404

■ TYPICAL CHARACTERISTICS

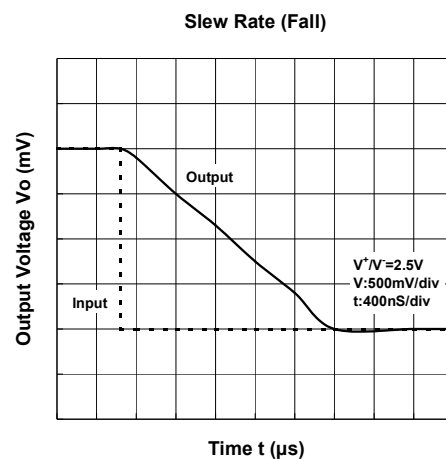
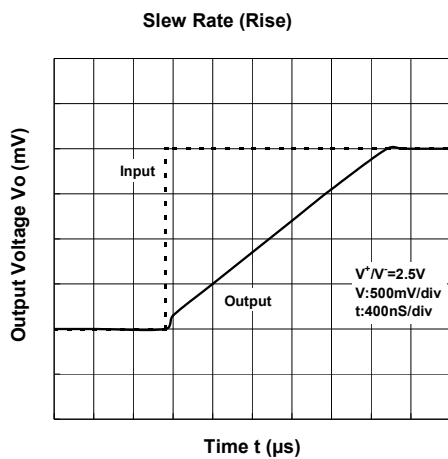
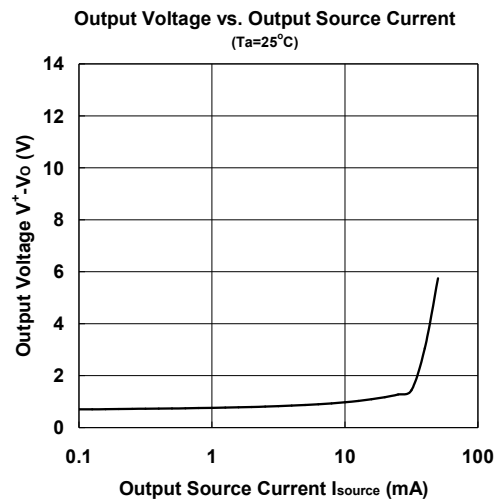
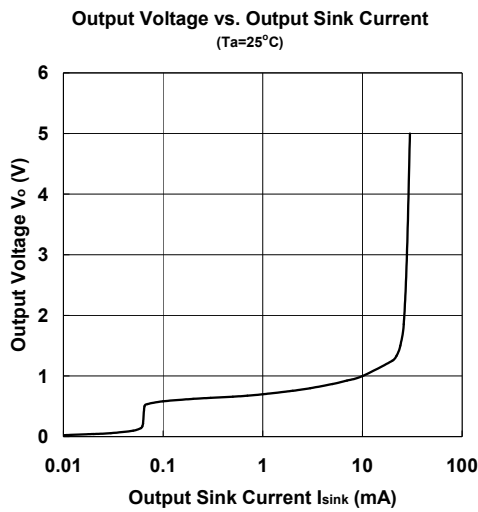
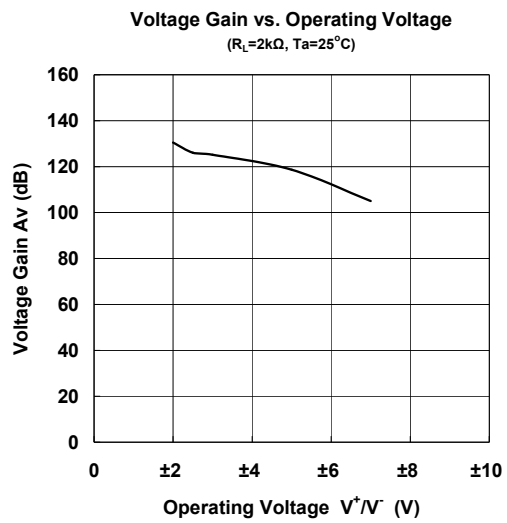
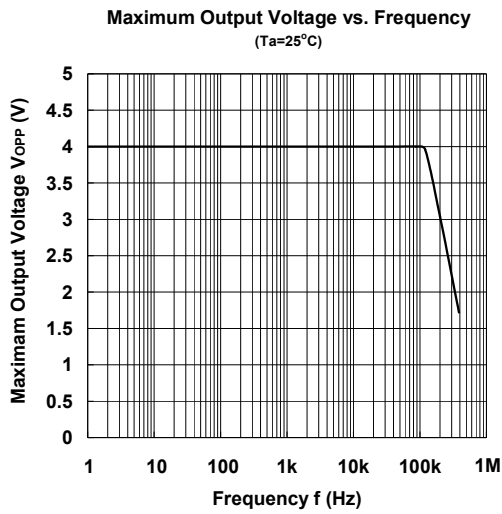

■ TYPICAL CHARACTERISTICS

Voltage Gain / Phase vs. Frequency
($T_a=25^\circ\text{C}$)

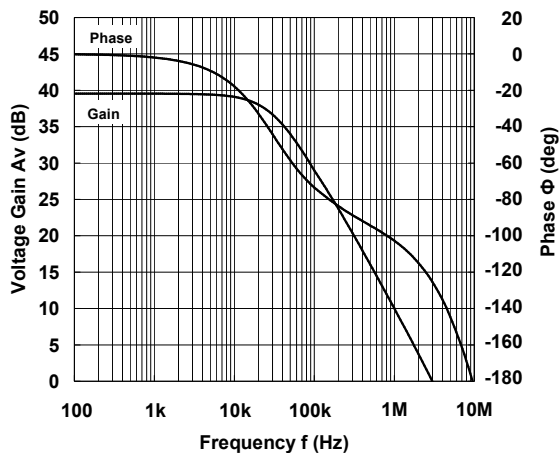

Total Harmonic Distortion vs. Output Voltage

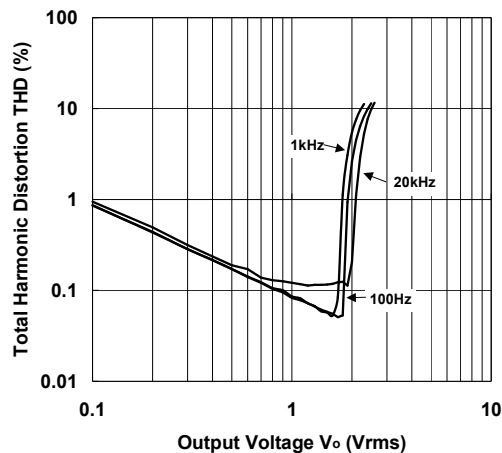

Equivalent Input Noise Voltage v.s Frequency

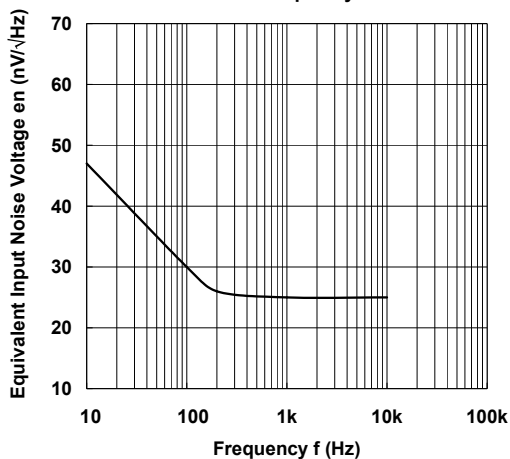

Operating Current vs. Ambient Temperature

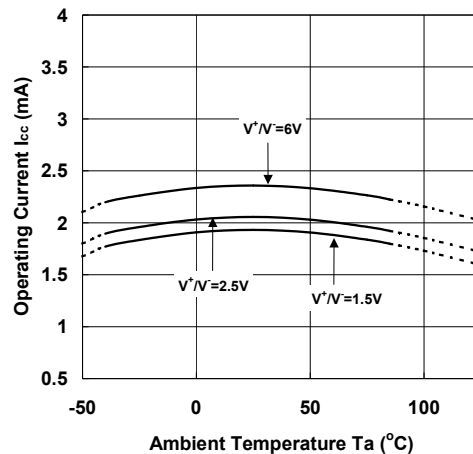

Input Offset Voltage vs. Ambient Temperature

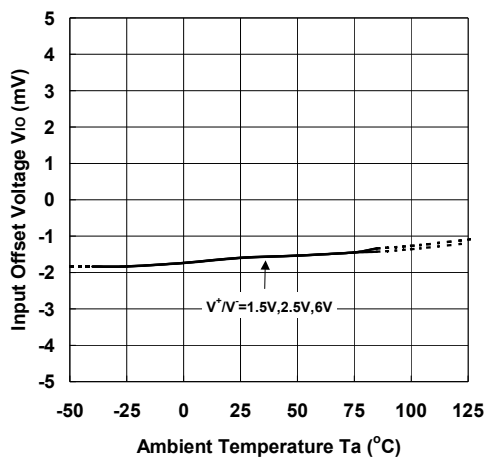

Input Bias Current vs. Ambient Temperature

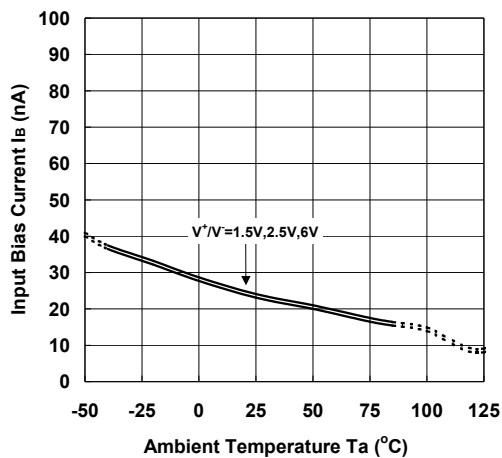

■ TYPICAL CHARACTERISTICS

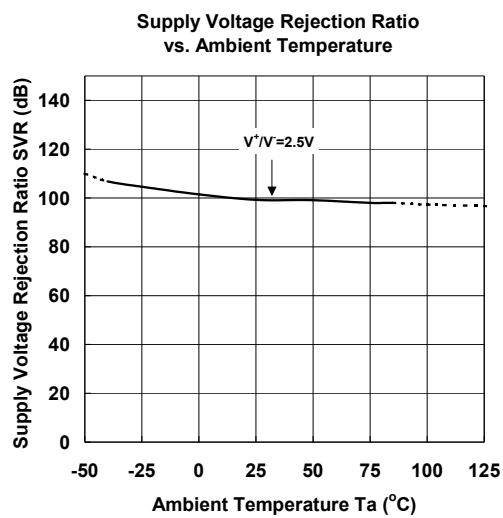
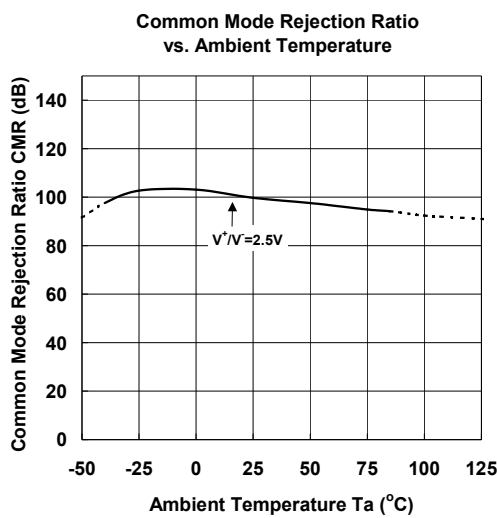
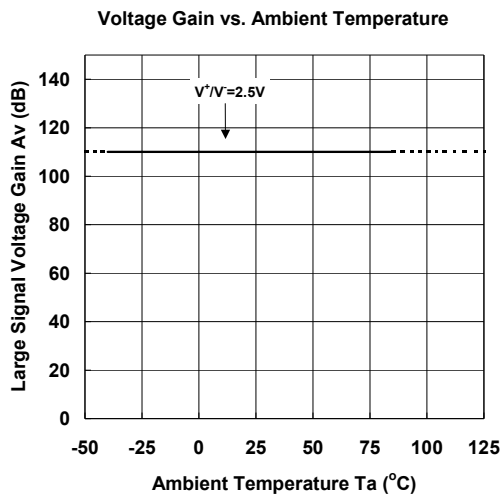
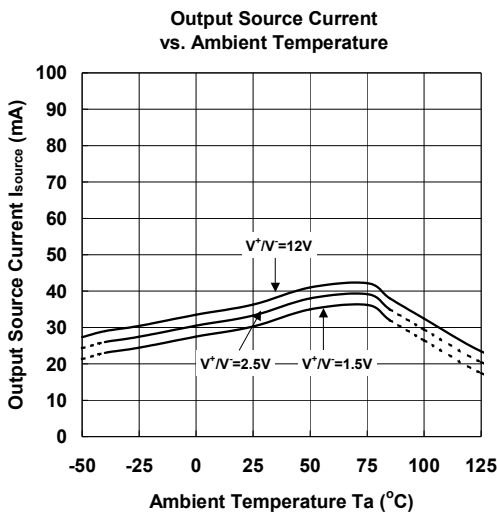
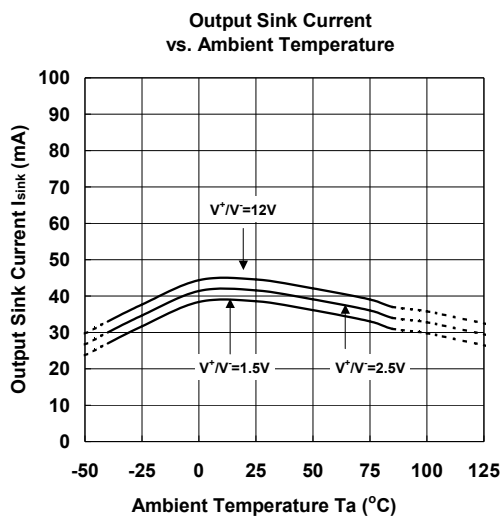
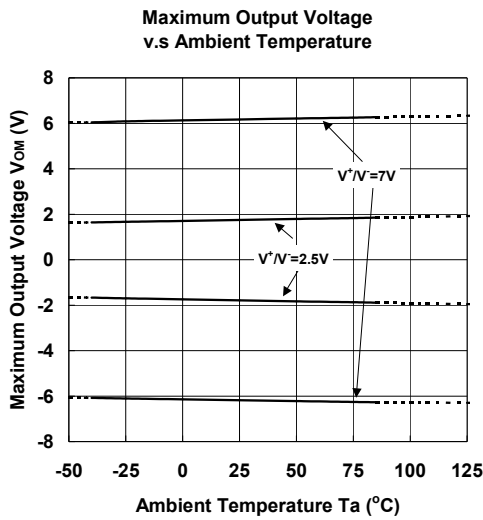

[CAUTION]

The specifications on this data book are only given for information, without any guarantee as regards either mistakes or omissions. The application circuits in this data book are described only to show representative usages of the product and not intended for the guarantee or permission of any right including the industrial rights.