

SP3T SWITCH GaAs MMIC

■ GENERAL DESCRIPTION

The NJG1804K64 is a GaAs SP3T switch MMIC which is suitable for WLAN(802.11a/b/g/n/ac) and Bluetooth applications. This MMIC switches between a common RF port and three RF ports by three control voltages. The NJG1804K64 features very low insertion loss, high isolation at wide frequency range up to 6.0GHz. The ultra small and ultra thin DFN8-64 package is adopted.

■ PACKAGE OUTLINE

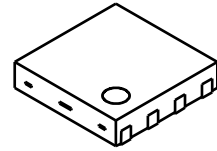

NJG1804K64

■ APPLICATION

- 802.11a/b/g/n/ac WLAN applications
- Bluetooth
- General purpose switching applications

■ FEATURES

- Low control voltage $V_{CTL(H)}=1.9V$ to $5.0V$
- Low insertion Loss 0.50dB typ. @f=2.4 to 2.5GHz, 0.60dB typ. @f=4.9 to 5.9GHz
- High isolation 30dB typ. @f=2.4 to 2.5GHz, 26dB typ. @f=4.9 to 5.9GHz
- Ultra small & ultra thin package DFN8-64 (Package size: 1.5 x 1.5 x 0.375mm)
- RoHS compliant and Halogen free, MSL1

■ PIN CONFIGURATION

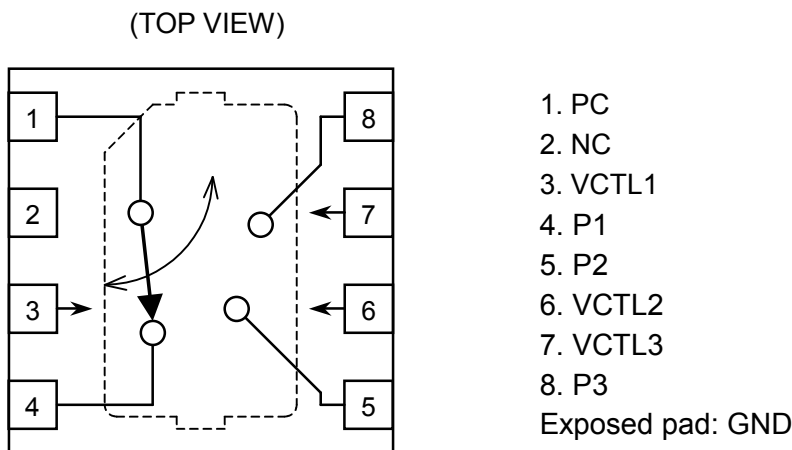

■ TRUTH TABLE

"H"= $V_{CTL(H)}$, "L"= $V_{CTL(L)}$

VCTL1	VCTL2	VCTL3	PATH
H	L	L	PC-P1
L	H	L	PC-P2
L	L	H	PC-P3

NOTE: Please note that any data or drawing in this catalog is subject to change.

■ ABSOLUTE MAXIMUM RATINGS

Ta=+25°C

PARAMETER	SYMBOL	CONDITIONS	RATINGS	UNITS
Input power	P _{IN}	V _{CTL(H)} =3.3V, V _{CTL(L)} =0V, ON state port	+30	dBm
Control voltage	V _{CTL}		5.0	V
Power dissipation	P _D	Four-layer FR4 PCB without through holes (76.2 x 114.3mm), T _j =150°C	380	mW
Operating temperature	T _{opr}		-40 to +105	°C
Storage temperature	T _{stg}		-55 to +150	°C

■ ELECTRICAL CHARACTERISTICS 1 (DC Characteristics)

General conditions: Ta=+25°C, V_{CTL(H)}=3.3V, V_{CTL(L)}=0V

PARAMETERS	SYMBOL	CONDITIONS	MIN	TYP	MAX	UNITS
Control voltage (HIGH)	V _{CTL(H)}		1.9	3.3	5.0	V
Control voltage (LOW)	V _{CTL(L)}		-0.2	-	0.2	V
Control current	I _{CTL}		-	4	10	μA

■ ELECTRICAL CHARACTERISTICS 2 (RF Characteristics)

General conditions: Ta=+25°C, V_{CTL(H)}=3.3V, V_{CTL(L)}=0V, Z_s=Z_l=50Ω

PARAMETERS	SYMBOL	CONDITIONS	MIN	TYP	MAX	UNITS
Insertion loss 1	LOSS1	f=2.4GHz to 2.5GHz	-	0.50	0.70	dB
Insertion loss 2	LOSS2	f=4.9GHz to 5.9GHz	-	0.60	0.80	dB
Isolation 1	ISL1	f=2.4GHz to 2.5GHz	27	30	-	dB
Isolation 2	ISL2	f=4.9GHz to 5.9GHz	24	26	-	dB
Input power at 1dB compression point 1	P _{-1dB1}	f=2.4GHz to 2.5GHz	+26	+29	-	dBm
Input power at 1dB compression point 2	P _{-1dB2}	f=4.9GHz to 5.9GHz	+26	+29	-	dBm
Return loss 1	RL1	f=2.4GHz to 2.5GHz	15	25	-	dB
Return loss 2	RL2	f=4.9GHz to 5.9GHz	15	20	-	dB
Switching time	T _{sw}	50% CTL to 10%/90% RF	-	80	300	ns

■ TERMINAL INFORMATION

No.	SYMBOL	DESCRIPTION
1	PC	Common RF terminal. An external DC blocking capacitor is required.
2	NC	No connected terminal. This terminal is not connected with internal circuit. This terminal please connects to the PCB ground plane or floating.
3	VCTL1	Control voltage input terminal.
4	P1	RF terminal. An external DC blocking capacitor is required.
5	P2	RF terminal. An external DC blocking capacitor is required.
6	VCTL2	Control voltage input terminal.
7	VCTL3	Control voltage input terminal.
8	P3	RF terminal. An external DC blocking capacitor is required.
Exposed Pad	GND	Ground terminal. Connect exposed pad to ground plane as close as possible for excellent RF performance.

■ ELECTRICAL CHARACTERISTICS

LOSS, ISL vs Frequency

(PC-P1 ON, $V_{CTL(H)}=3.3V$, $V_{CTL(L)}=0V$)

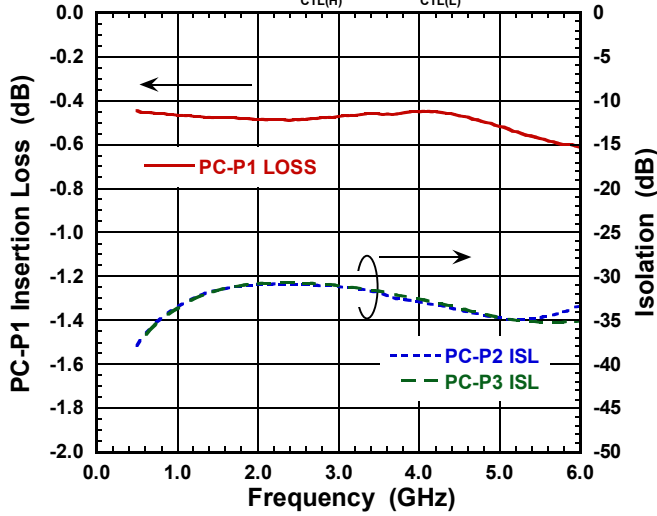

LOSS, ISL vs Frequency

(PC-P2 ON, $V_{CTL(H)}=3.3V$, $V_{CTL(L)}=0V$)

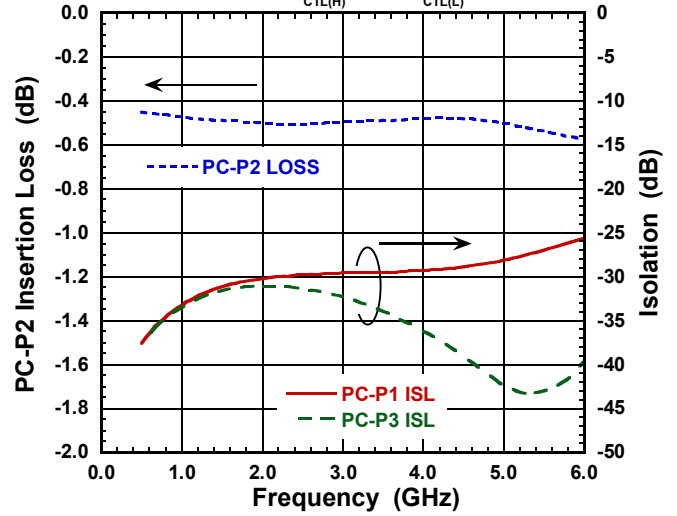

LOSS, ISL vs Frequency

(PC-P3 ON, $V_{CTL(H)}=3.3V$, $V_{CTL(L)}=0V$)

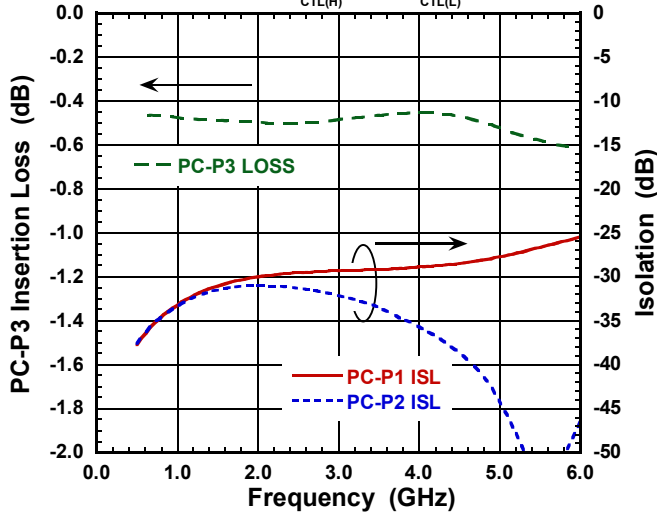

Return Loss vs Frequency

(PC-P1 ON, $V_{CTL(H)}=3.3V$, $V_{CTL(L)}=0V$)

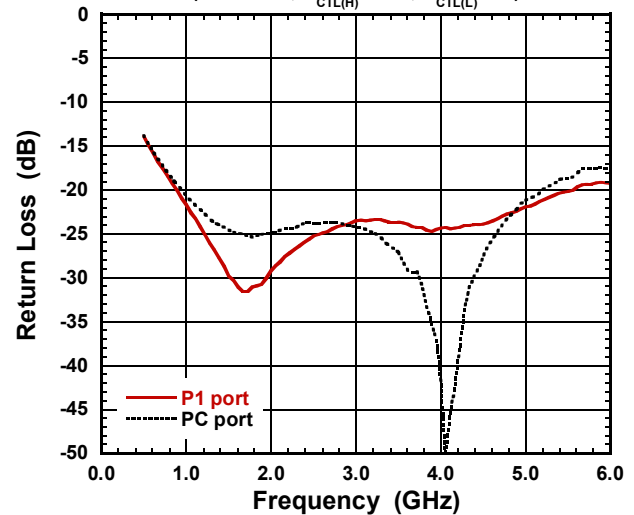

Return Loss vs Frequency

(PC-P2 ON, $V_{CTL(H)}=3.3V$, $V_{CTL(L)}=0V$)

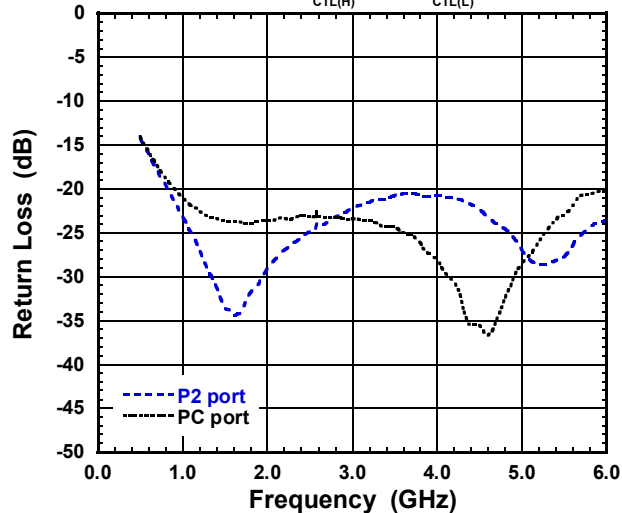

Return Loss vs Frequency

(PC-P3 ON, $V_{CTL(H)}=3.3V$, $V_{CTL(L)}=0V$)

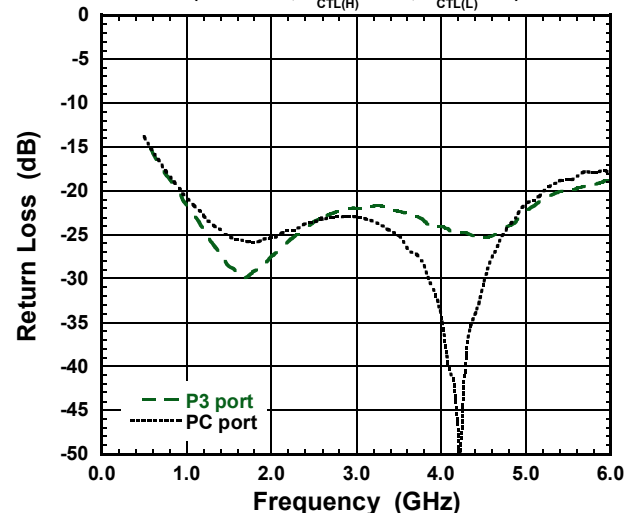

ELECTRICAL CHARACTERISTICS

Output Power, I_{CTL} vs Input Power

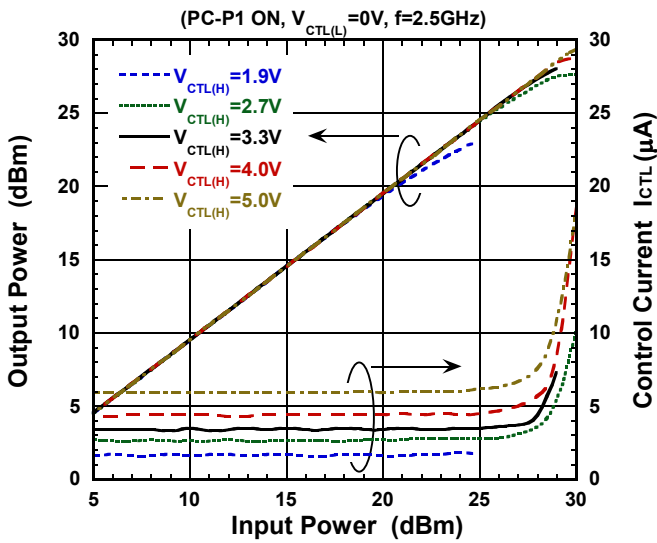

LOSS, ISL vs Input Power

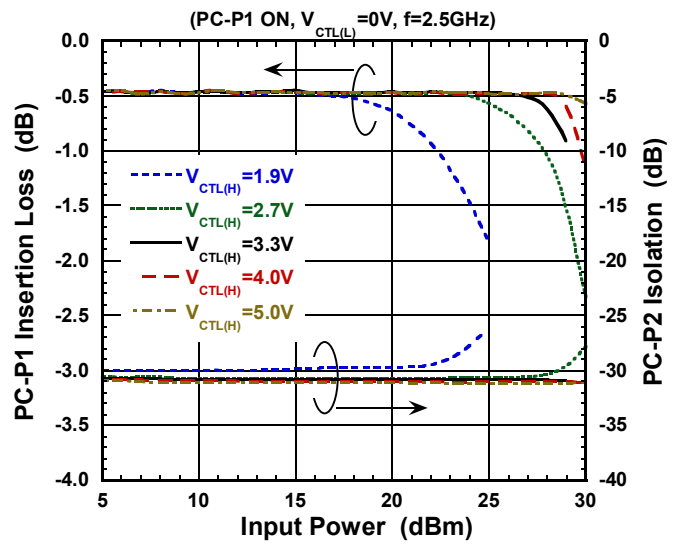

Output Power, I_{CTL} vs Input Power

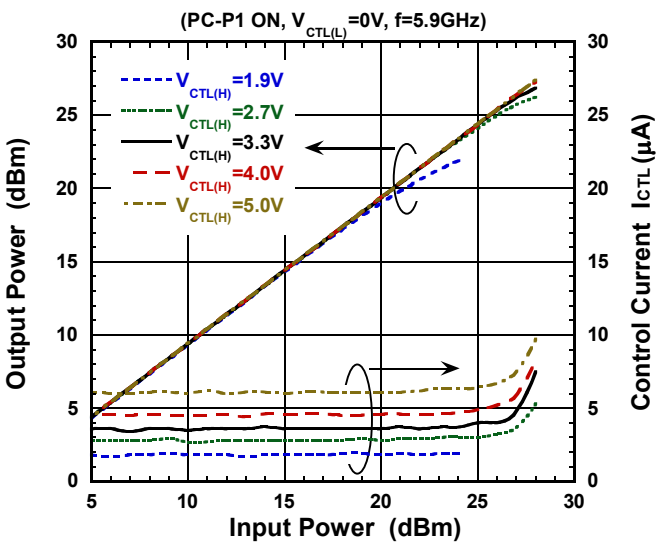

LOSS, ISL vs Input Power

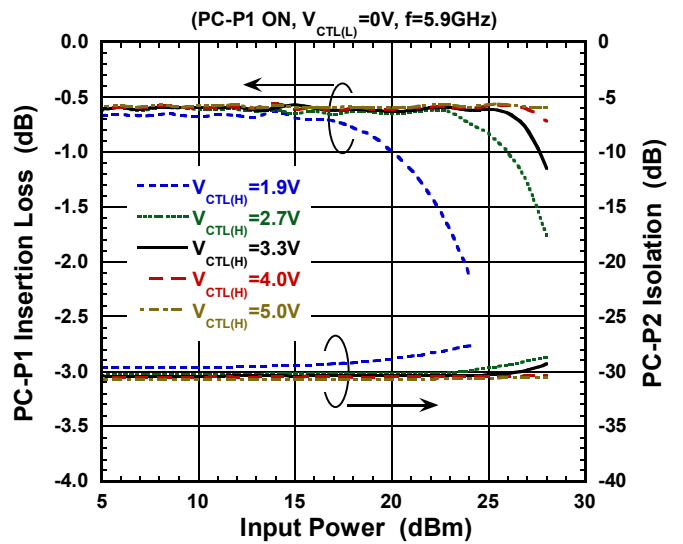

Switching Time

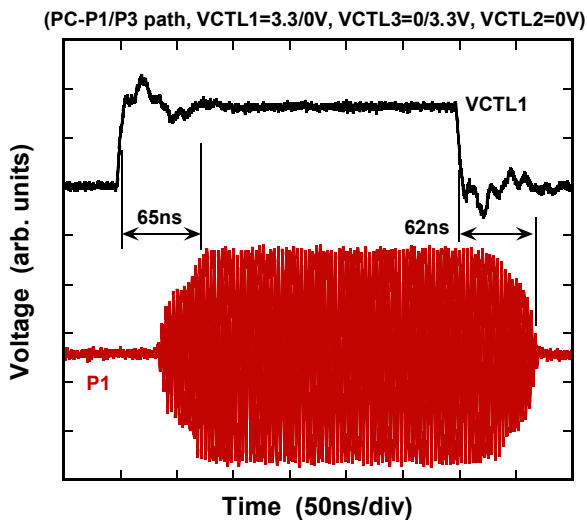

■ ELECTRICAL CHARACTERISTICS

Output Power, IM3 vs Input Power

(P1-PC ON, $V_{CTL(H)}=3.3V$, $V_{CTL(L)}=0V$, $f=2.45+2.451GHz$)

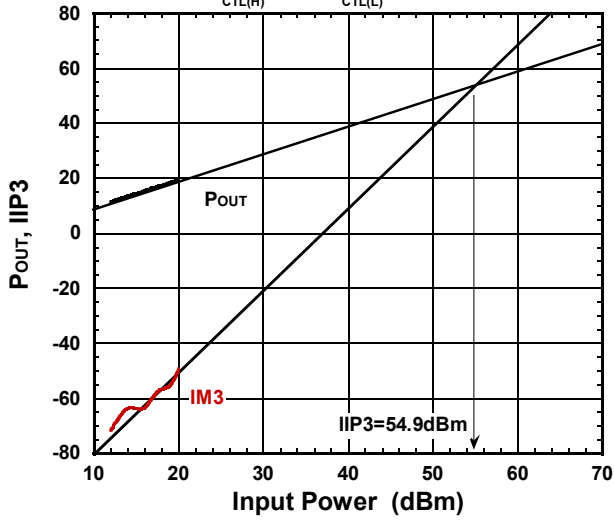

IIP3 vs Input Power

(P1-PC ON, $V_{CTL(L)}=0V$, $f=2.45+2.451GHz$)

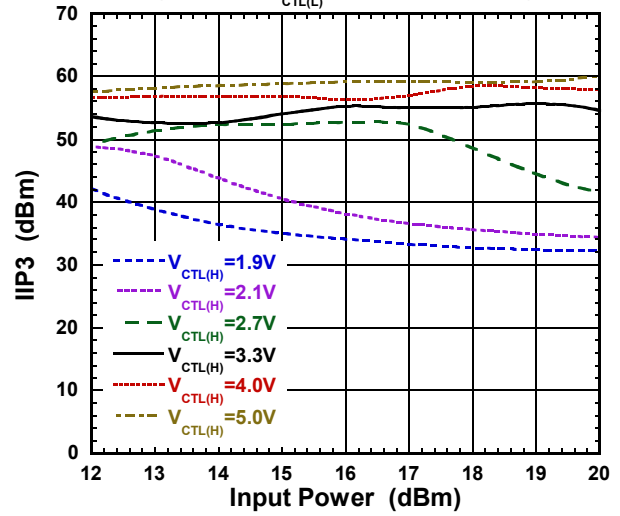

EVM vs Input Power (f=2.5GHz)

(P1-PC ON, $V_{CTL(L)}=0V$, $f=2.5GHz$, OFDM 64QAM)

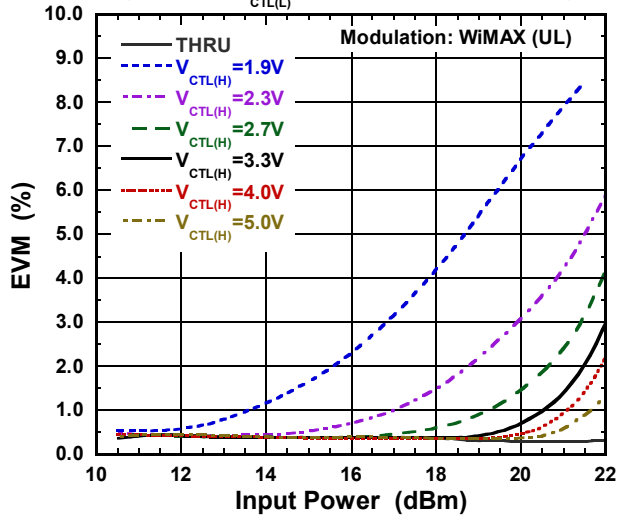

EVM vs Input Power (f=5.9GHz)

(P1-PC ON, $V_{CTL(L)}=0V$, $f=5.9GHz$, OFDM 64QAM)

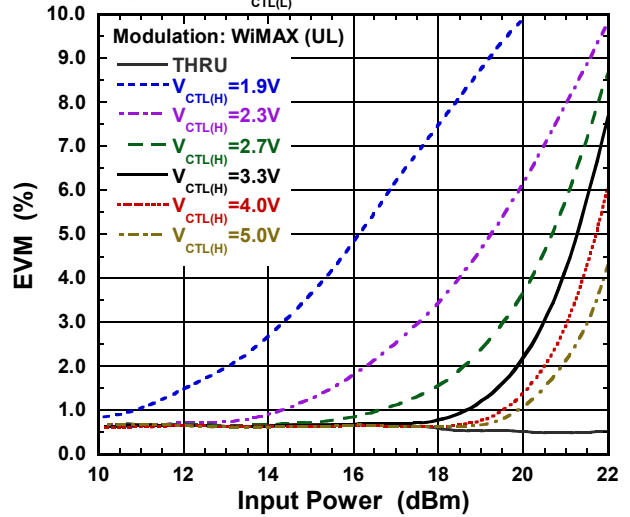

■ ELECTRICAL CHARACTERISTICS

LOSS, ISL vs Temperature

(PC-P1 ON, $V_{CTL(L)}=0V$, $f=2.5GHz$, $P_{IN}=13dBm$)

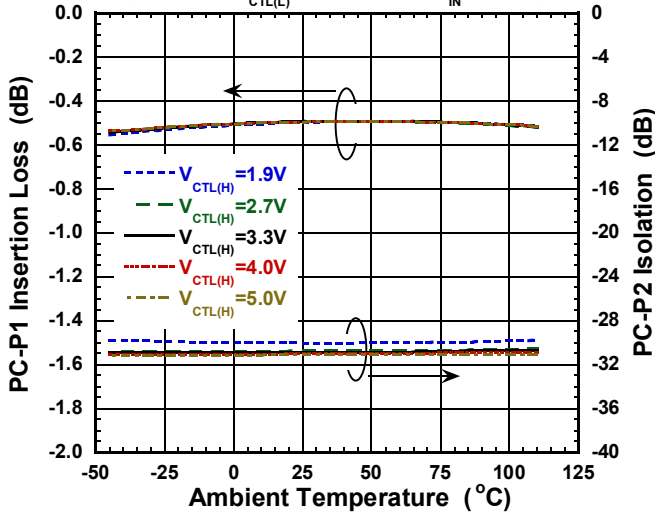

LOSS, ISL vs Temperature

(PC-P1 ON, $V_{CTL(L)}=0V$, $f=5.9GHz$, $P_{IN}=13dBm$)

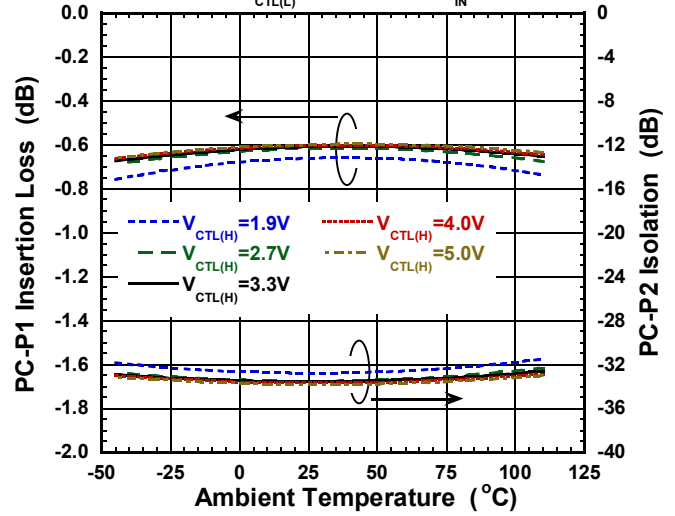

Return Loss vs Temperature

(P1-PC ON, $V_{CTL(L)}=0V$)

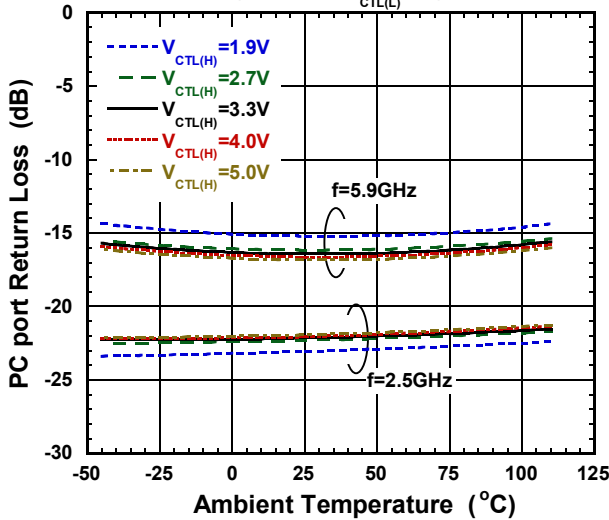

Control Current vs Temperature

(P1-PC ON, $V_{CTL(L)}=0V$)

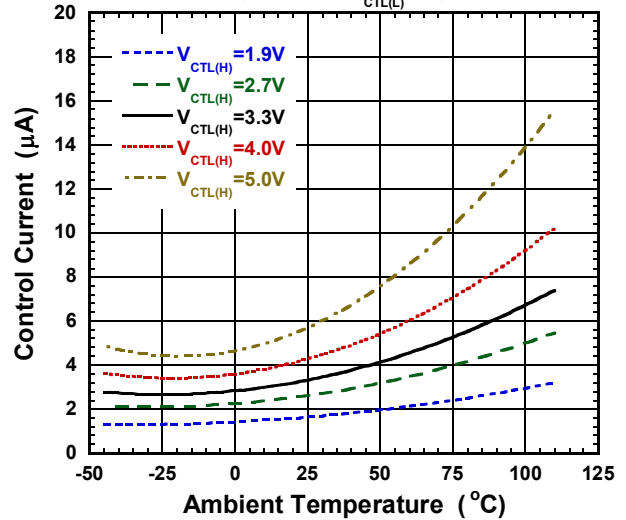

P-1dB vs Temperature

(P1-PC ON, $V_{CTL(L)}=0V$, $f=2.5GHz$)

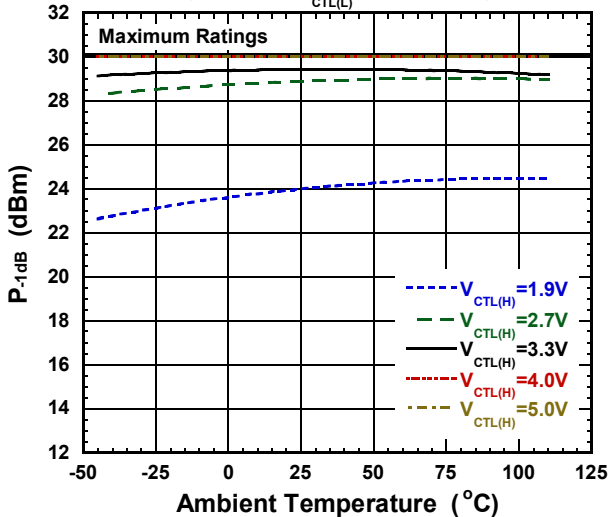

Switching Time(rise) vs Temperature

(PC-P1/P3 path, P1 port, $V_{CTL(L)}=0V$)

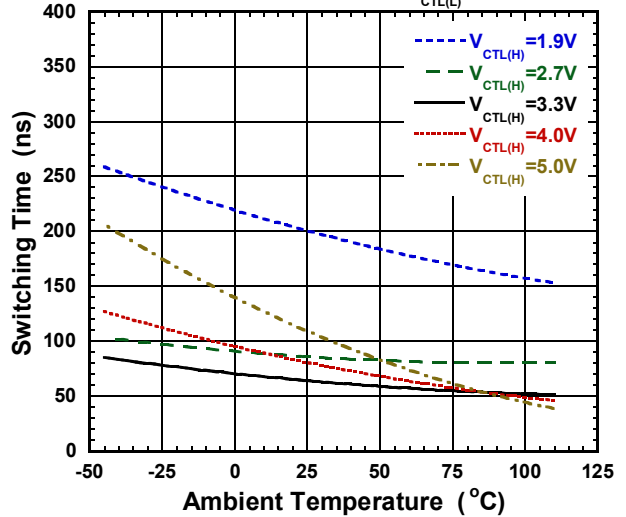

APPLICATION CIRCUIT

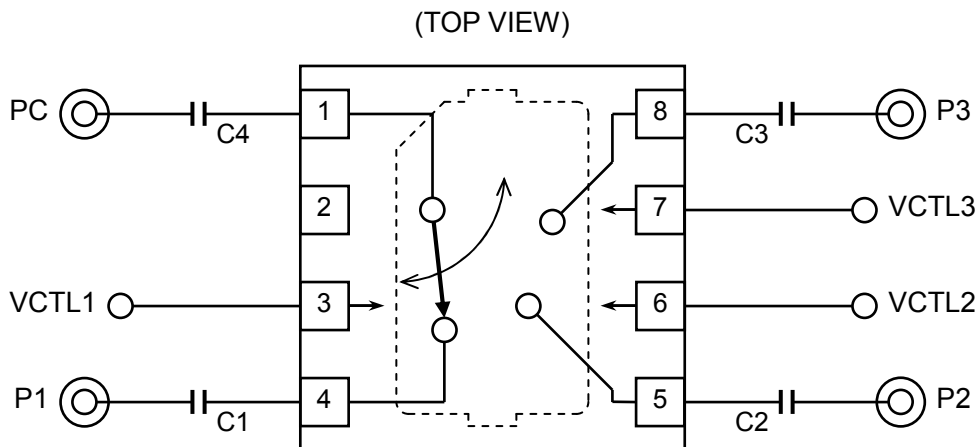

RECOMMENDED PCB DESIGN

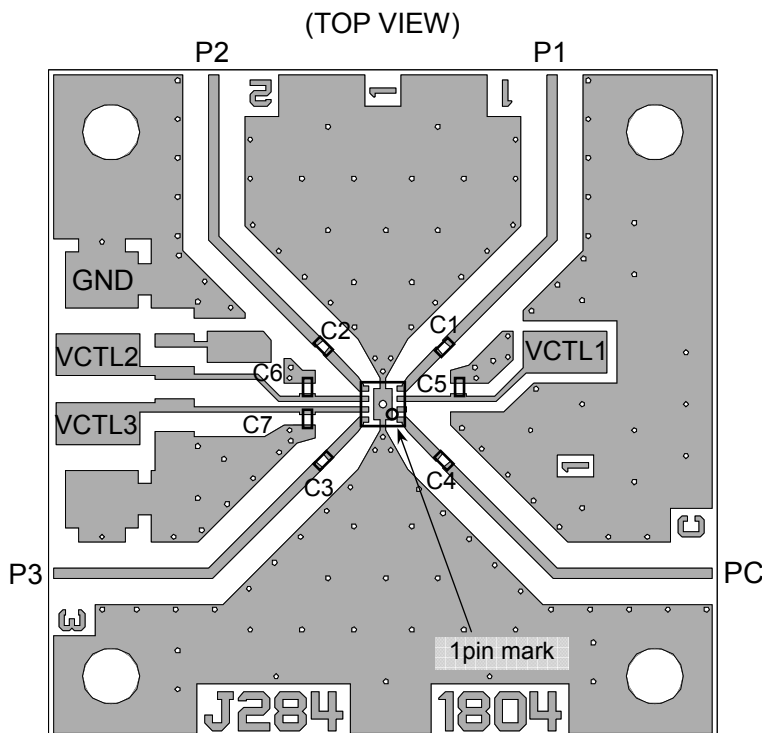

PCB: FR-4, $t=0.2\text{mm}$
 Capacitor size: 0603 (0.6 x 0.3 mm)
 Strip line width: 0.38mm
 PCB size: 25.8 x 25.8mm
 Through hole diameter: 0.2mm

Losses of PCB, capacitors and connectors

Frequency (GHz)	Loss (dB)
2.4	0.50
2.5	0.52
4.9	0.87
5.9	1.02

NOTE

The bypass capacitors, C5 to C7 are optional, and are recommended only when the control lines are affected under noisy environment.

PARTS LIST

No.	Value	Notes
C1 to C4	27pF	Murata MFG (GRM03 series)
C5 to C7	10pF	

■ PCB LAYOUT GUIDELINE

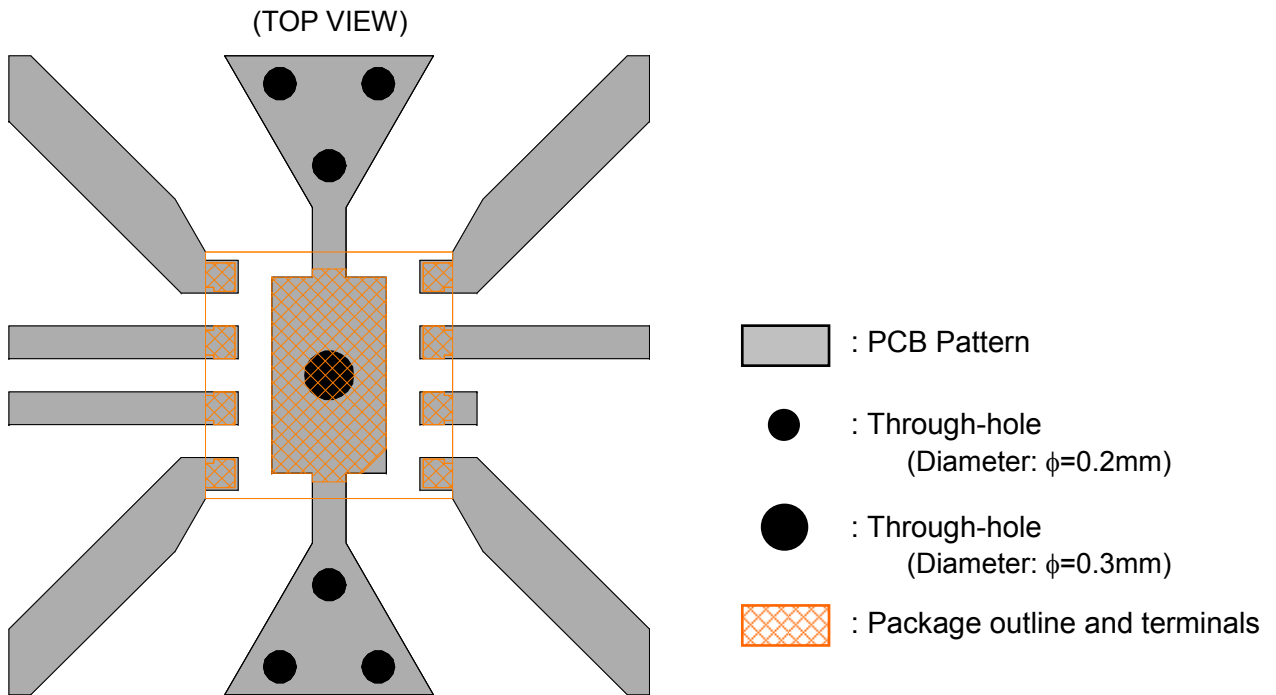

PRECAUTIONS

- [1] The DC blocking capacitors should be placed at RF terminals. Please choose appropriate capacitance value at the application frequency.
- [2] If the bypass capacitors (C5 to C7) are needed, they should be placed as close as possible to VCTL terminals.
- [3] For good RF performance, exposed pad should be connected to PCB ground plane as close as possible.

■ RECOMMENDED FOOTPRINT PATTERN (8pin DFN Package 1.5x1.5mm) <Reference>

Package: 1.5mm x 1.5mm

Pin pitch: 0.4mm

 : Land

 : Mask (Open area) *Metal mask thickness: 100um

 : Resist (Open area)

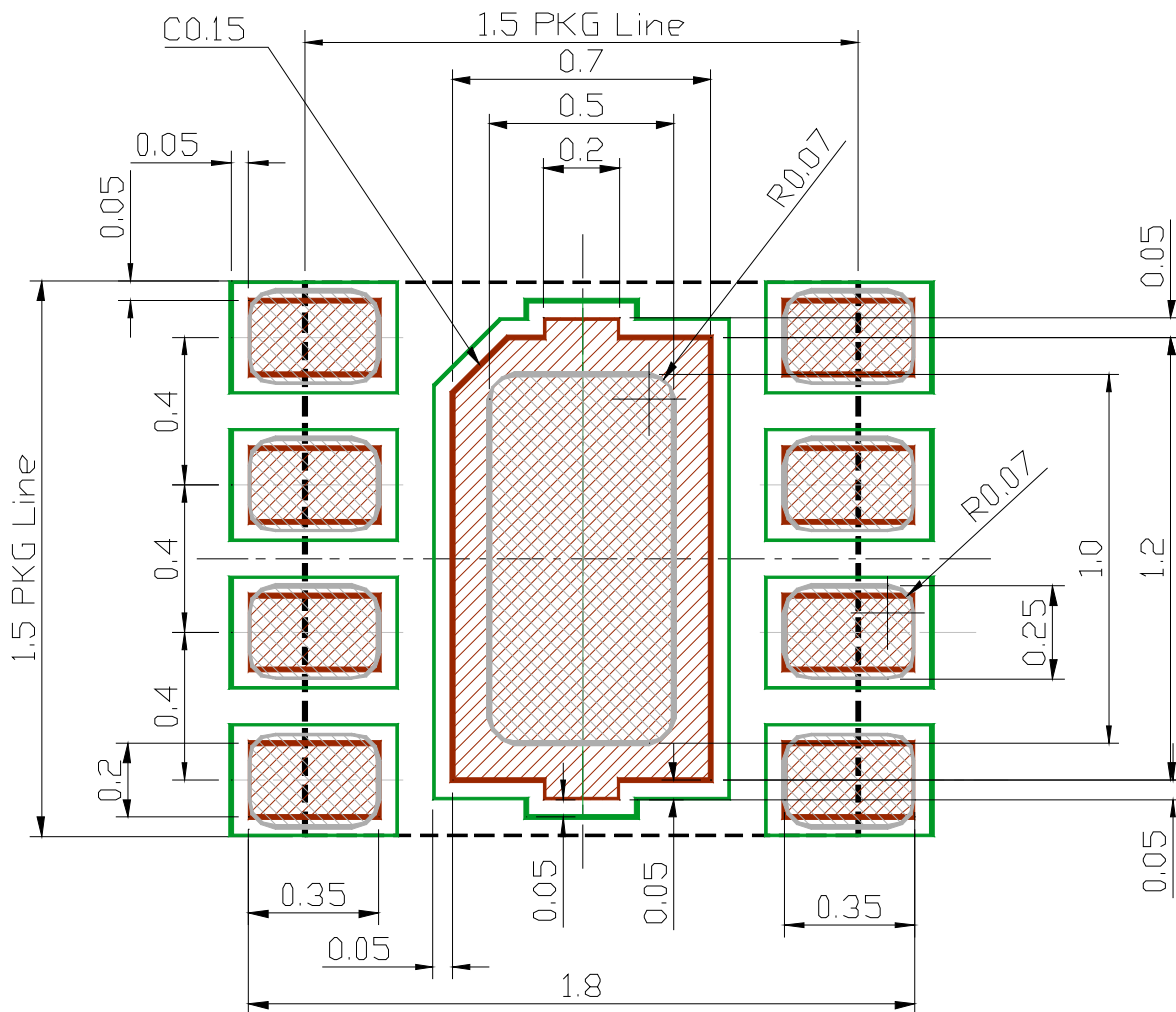

PACKAGE OUTLINE (DFN8-64)

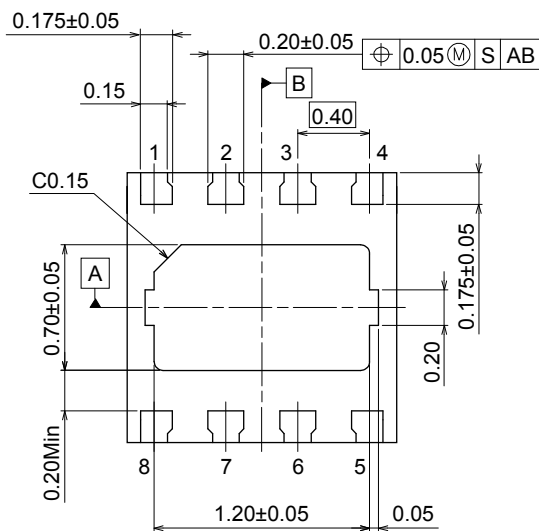
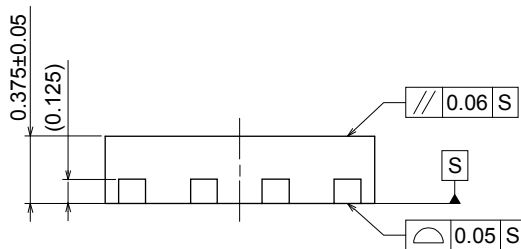
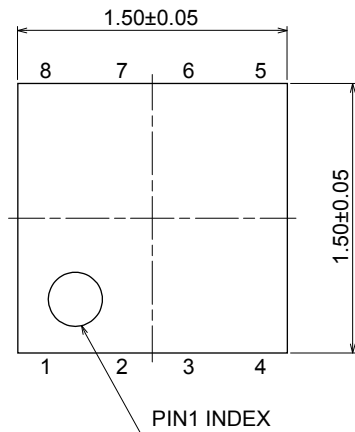

Unit	: mm
Board	: Copper
Terminal Treat	: Ni/Pd/Au
Molding Material	: Epoxy resin
Weight	: 2.8mg

Cautions on using this product

- This product contains Gallium-Arsenide (GaAs) which is a harmful material.
- Do NOT eat or put into mouth.
- Do NOT dispose in fire or break up this product.
- Do NOT chemically make gas or powder with this product.
- To waste this product, please obey the relating law of your country.

[CAUTION]

The specifications on this databook are only given for information, without any guarantee as regards either mistakes or omissions. The application circuits in this databook are described only to show representative usages of the product and not intended for the guarantee or permission of any right including the industrial rights.

This product may be damaged with electric static discharge (ESD) or spike voltage. Please handle with care to avoid these damages.