

HIGH POWER SP3T SWITCH GaAs MMIC

■ GENERAL DESCRIPTION

The NJG1682MD7 is a GaAs SP3T switch MMIC suitable for LTE/UMTS/CDMA/GSM applications.

The NJG1682MD7 features very low insertion loss, high isolation and excellent linearity performance down to 1.8V control voltage at high frequency up to 2.7GHz. In addition, this switch is able to handle high power signals.

The NJG1682MD7 has ESD protection devices to achieve excellent ESD performances. No DC Blocking capacitors are required for all RF ports unless DC is biased externally. And the ultra small & ultra thin EQFN14-D7 package is adopted.

■ PACKAGE OUTLINE

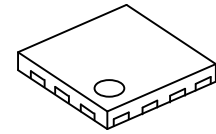

NJG1682MD7

■ APPLICATIONS

- LTE, UMTS, CDMA, GSM applications
- Post PA Switching, Antenna Switching and Bands Switching applications
- General Purpose Switching applications

■ FEATURES

- Low voltage logic control
 - Low voltage operation
 - Low distortion
 - P-0.1dB
 - Low insertion loss
 - Ultra small & ultra thin package
 - RoHS compliant and Halogen Free, MSL1
- $V_{CTL(H)}=1.8V$ typ.
 $V_{DD}=2.7V$ typ.
 $IIP3=+71dBm$ typ. @f=829+849MHz, $P_{IN}=24dBm$,
 $IIP3=+70dBm$ typ. @f=1870+1910MHz, $P_{IN}=24dBm$,
 $2nd\ harmonics=-85dBc$ typ. @f=0.9GHz, $P_{IN}=35dBm$
 $3rd\ harmonics=-80dBc$ typ. @f=0.9GHz, $P_{IN}=35dBm$
 $36dBm$ min.
 $0.22dB$ typ. @f=0.9GHz, $P_{IN}=35dBm$
 $0.25dB$ typ. @f=1.9GHz, $P_{IN}=33dBm$
 $0.30dB$ typ. @f=2.7GHz, $P_{IN}=27dBm$
 EQFN14-D7 (Package size: 1.6 x 1.6 x 0.397mm.)

■ PIN CONFIGURATION

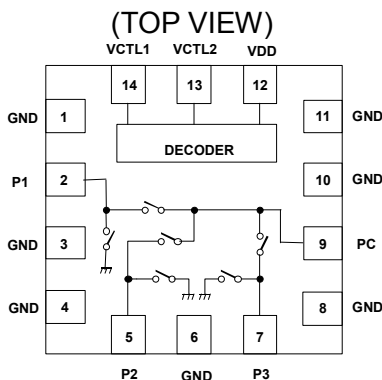

Pin connection

- | | |
|--------|-----------|
| 1. GND | 8. GND |
| 2. P1 | 9. PC |
| 3. GND | 10. GND |
| 4. GND | 11. GND |
| 5. P2 | 12. VDD |
| 6. GND | 13. VCTL2 |
| 7. P3 | 14. VCTL1 |

Exposed PAD: GND

■ TRUTH TABLE

“H”= $V_{CTL(H)}$, “L”= $V_{CTL(L)}$

VCTL1	VCTL2	Path
L	L	ALL OFF
H	L	P1-PC
L	H	P2-PC
H	H	P3-PC

NOTE: Please note that any information on this catalog will be subject to change.

NJG1682MD7

■ ABSOLUTE MAXIMUM RATINGS

$T_a=+25^{\circ}\text{C}$, $Z_s=Z_i=50\ \text{ohm}$

PARAMETER	SYMBOL	CONDITIONS	RATINGS	UNITS
RF Input Power	P_{IN}	$V_{DD}=2.7\text{V}$	37	dBm
Supply Voltage	V_{DD}		5.0	V
Control Voltage	V_{CTL}		5.0	V
Power Dissipation	P_D	Four-layer FR4 PCB with through-hole (74.2x74.2mm), $T_j=150^{\circ}\text{C}$	1300	mW
Operating Temp.	T_{opr}		-40~+85	$^{\circ}\text{C}$
Storage Temp.	T_{stg}		-55~+150	$^{\circ}\text{C}$

■ ELECTRICAL CHARACTERISTICS 1 (DC)

General conditions: $T_a=+25^{\circ}\text{C}$, $V_{DD}=2.7\text{V}$, $V_{CTL(L)}=0\text{V}$, $V_{CTL(H)}=1.8\text{V}$

PARAMETERS	SYMBOL	CONDITIONS	MIN	TYP	MAX	UNITS
Supply Voltage	V_{DD}		2.375	2.7	5.0	V
Operating Current	I_{DD}	No RF input, $V_{DD}=2.7\text{V}$	-	150	300	μA
Control Voltage (LOW)	$V_{CTL(L)}$		0	-	0.45	V
Control Voltage (HIGH)	$V_{CTL(H)}$		1.35	1.8	5.0	V
Control Current	I_{CTL}	$V_{CTL(H)}=1.8\text{V}$	-	4	10	μA

■ ELECTRICAL CHARACTERISTICS 2 (RF)

General conditions: $T_a=+25^{\circ}\text{C}$, $Z_s=Z_l=50\ \text{ohm}$, $V_{DD}=2.7\text{V}$, $V_{CTL(L)}=0\text{V}$, $V_{CTL(H)}=1.8\text{V}$

PARAMETERS	SYMBOL	CONDITIONS	MIN	TYP	MAX	UNITS
Insertion Loss 1	LOSS1	f=0.9GHz, P _{IN} =35dBm	-	0.22	0.37	dB
Insertion Loss 2	LOSS2	f=1.9GHz, P _{IN} =33dBm	-	0.25	0.45	dB
Insertion Loss 3	LOSS3	f=2.7GHz, P _{IN} =27dBm	-	0.30	0.50	dB
Isolation 1	ISL1	f=0.9GHz, P _{IN} =35dBm	30	35	-	dB
Isolation 2	ISL2	f=1.9GHz, P _{IN} =33dBm	25	30	-	dB
Isolation 3	ISL3	f=2.7GHz, P _{IN} =27dBm	22	27	-	dB
Isolation 4	ISL4	f=0.9GHz, P _{IN} =10dBm, ALL OFF mode	30	35	-	dB
Isolation 5	ISL5	f=1.9GHz, P _{IN} =10dBm, ALL OFF mode	25	30	-	dB
Isolation 6	ISL6	f=2.7GHz, P _{IN} =10dBm, ALL OFF mode	21	25	-	dB
Input Power at 0.1dB Compression Point	P _{-0.1dB}	f=0.9GHz, 1.9GHz, 2.7GHz	36	-	-	dBm
2nd Harmonics 1	2fo(1)	f=0.9GHz, P _{IN} =35dBm	-	-85	-70	dBc
2nd Harmonics 2	2fo(2)	f=1.9GHz, P _{IN} =33dBm	-	-85	-70	dBc
2nd Harmonics 3	2fo(3)	f=2.7GHz, P _{IN} =27dBm	-	-90	-70	dBc
3rd Harmonics 1	3fo(1)	f=0.9GHz, P _{IN} =35dBm	-	-80	-70	dBc
3rd Harmonics 2	3fo(2)	f=1.9GHz, P _{IN} =33dBm	-	-80	-70	dBc
3rd Harmonics 3	3fo(3)	f=2.7GHz, P _{IN} =27dBm	-	-90	-70	dBc
Input 3 rd order intercept point1	IIP3(1)	f=829+849MHz, P _{IN} =+24dBm each*1	+65	+71	-	dBm
Input 3 rd order intercept point2	IIP3(2)	f=1870+1910MHz, P _{IN} =+24dBm each*1	+63	+70	-	dBm
VSWR	VSWR	on-state ports, f=2.7GHz	-	1.2	1.4	
Switching time	T _{SW}	50% V _{CTL} to 10/90% RF	-	1	5	μs

*1: IIP3 are defined by the following equations.

$$\text{IIP3} = (3 \times \text{Pout} - \text{IM3}) / 2 + \text{LOSS}$$

NJG1682MD7

■ TERMINAL INFORMATION

No.	SYMBOL	DESCRIPTION
1	GND	Ground terminal. Please connect this terminal with ground plane as close as possible for excellent RF performance.
2	P1	RF transmitting/receiving port. No DC blocking capacitor is required for this port unless DC is biased externally.
3	GND	Ground terminal. Please connect this terminal with ground plane as close as possible for excellent RF performance.
4	GND	Ground terminal. Please connect this terminal with ground plane as close as possible for excellent RF performance.
5	P2	RF transmitting/receiving port. No DC blocking capacitor is required for this port unless DC is biased externally.
6	GND	Ground terminal. Please connect this terminal with ground plane as close as possible for excellent RF performance.
7	P3	RF transmitting/receiving port. No DC blocking capacitor is required for this port unless DC is biased externally.
8	GND	Ground terminal. Please connect this terminal with ground plane as close as possible for excellent RF performance.
9	PC	RF transmitting/receiving port. No DC blocking capacitor is required for this port unless DC is biased externally. Please connect an inductor with GND terminal for ESD protection.
10	GND	Ground terminal. Please connect this terminal with ground plane as close as possible for excellent RF performance.
11	GND	Ground terminal. Please connect this terminal with ground plane as close as possible for excellent RF performance.
12	VDD	Positive voltage supply terminal. The positive voltage (+2.375~+5V) has to be supplied. Please connect a bypass capacitor with GND terminal for excellent RF performance.
13	VCTL2	Control signal input terminal. This terminal is set to High-Level (+1.35~+5.0V) or Low-Level (0~+0.45V).
14	VCTL1	Control signal input terminal. This terminal is set to High-Level (+1.35~+5.0V) or Low-Level (0~+0.45V).
Exposed Pad	GND	Ground terminal.

■ ELECTRICAL CHARACTERISTICS (With application circuit)

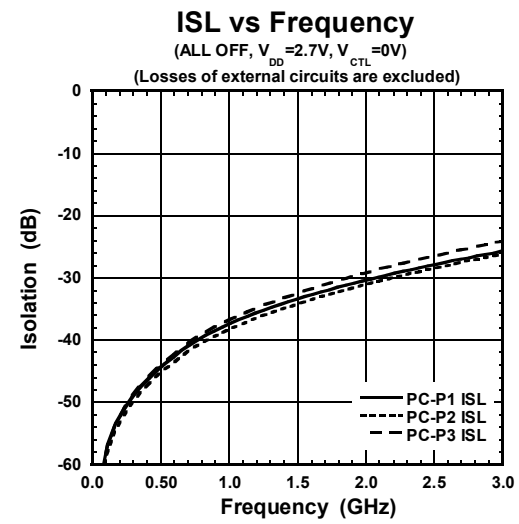
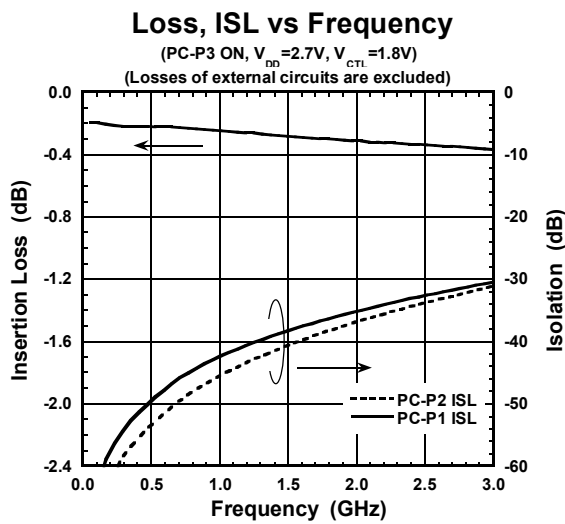
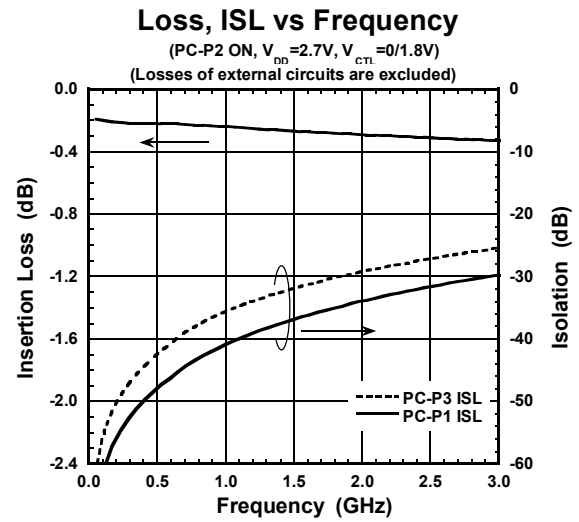
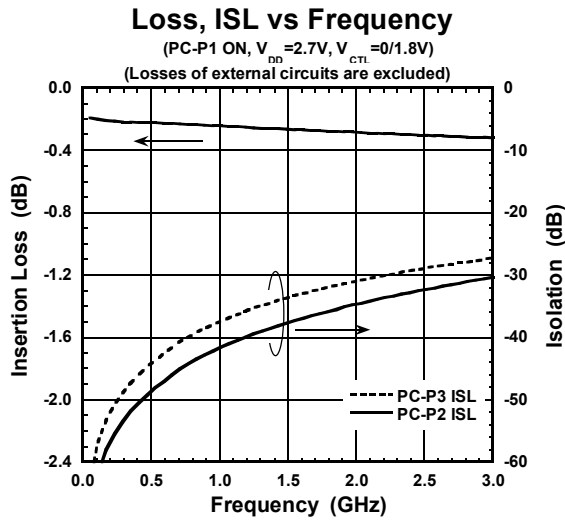

NJG1682MD7

ELECTRICAL CHARACTERISTICS (With application circuit)

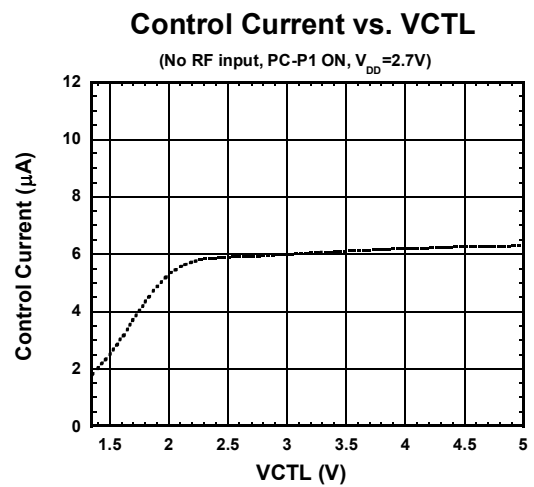
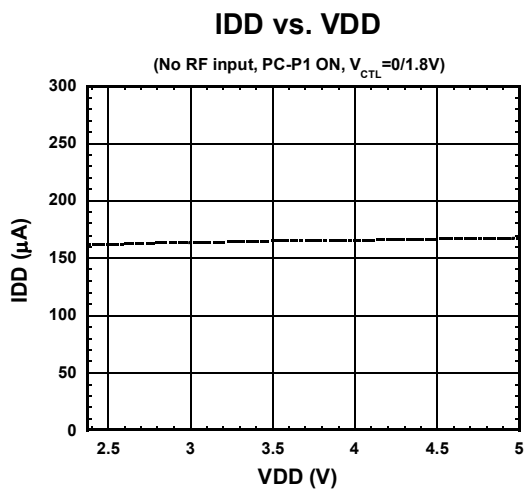
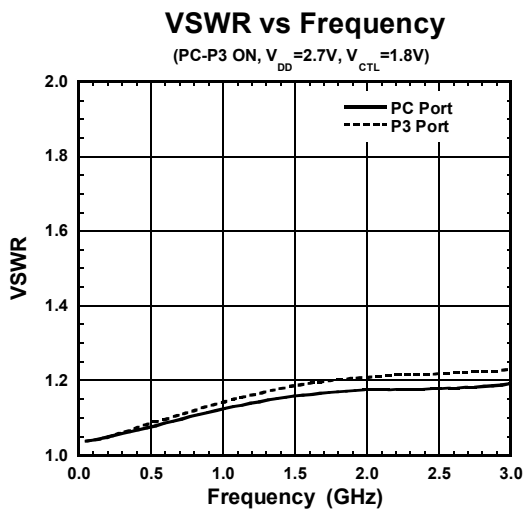
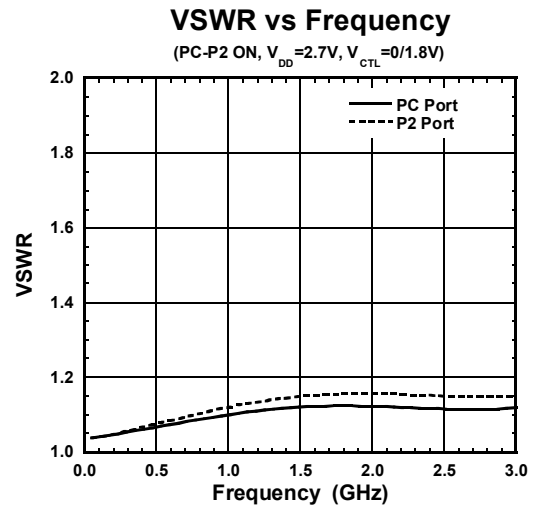
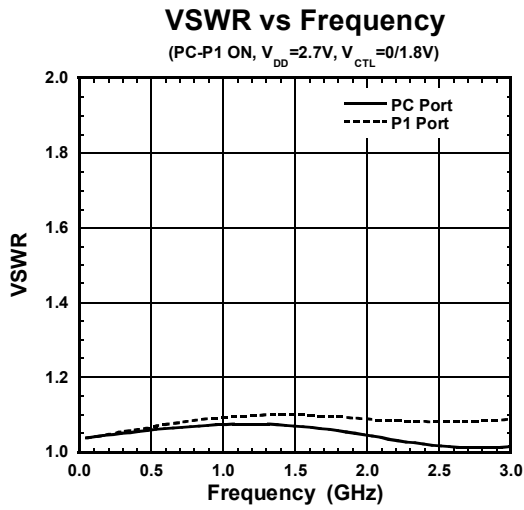

■ ELECTRICAL CHARACTERISTICS (With application circuit)

Output Power, I_{DD} vs Input Power

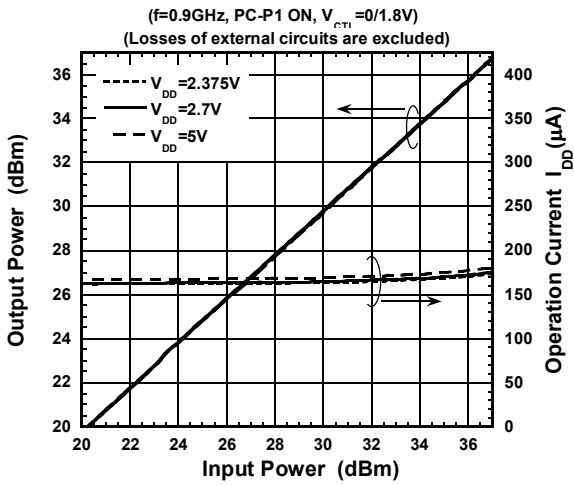

Output Power, I_{DD} vs Input Power

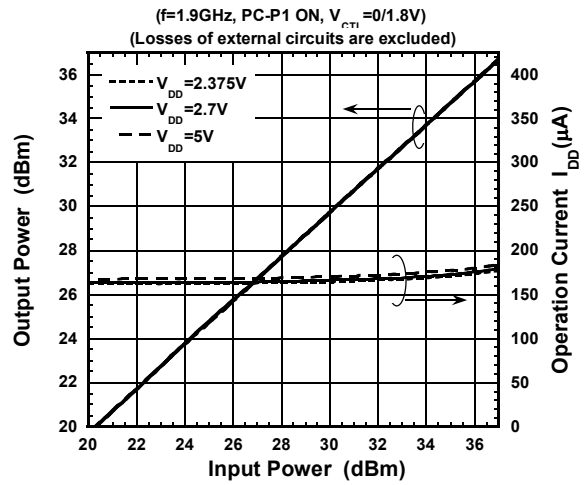

Output Power, I_{DD} vs Input Power

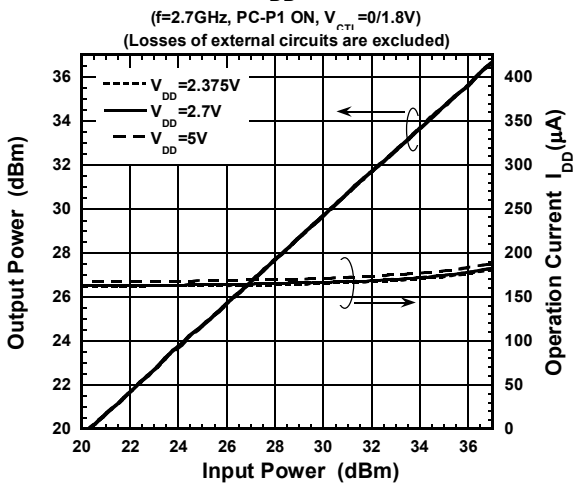

Loss, ISL vs Input Power

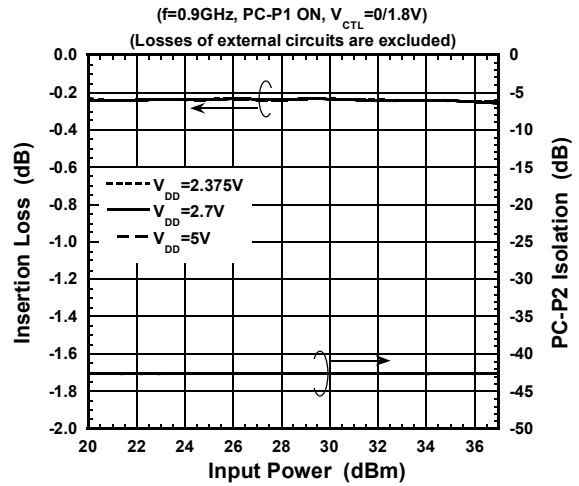

Loss, ISL vs Input Power

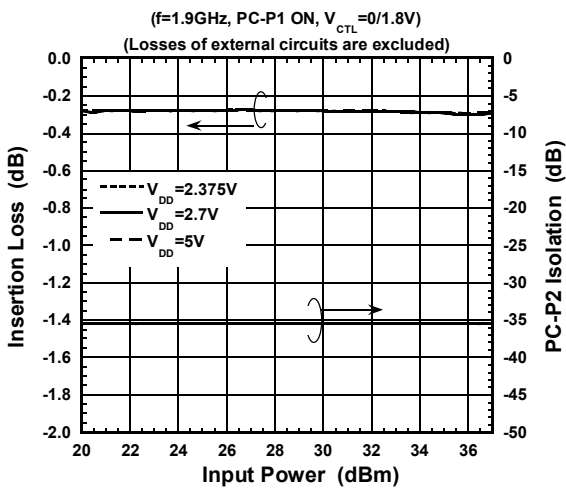

Loss, ISL vs Input Power

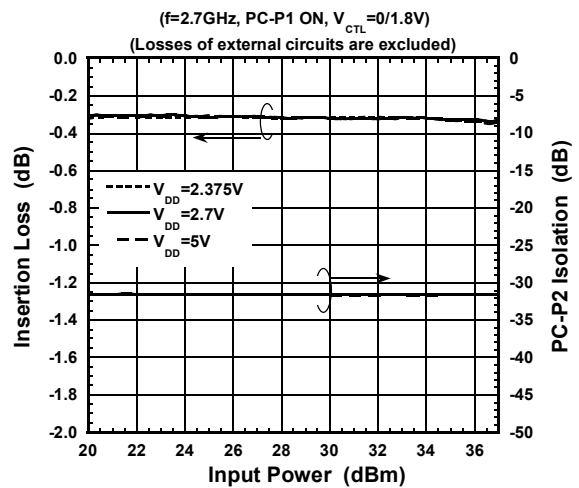

NJG1682MD7

ELECTRICAL CHARACTERISTICS (With application circuit)

Loss, ISL vs Ambient Temperature

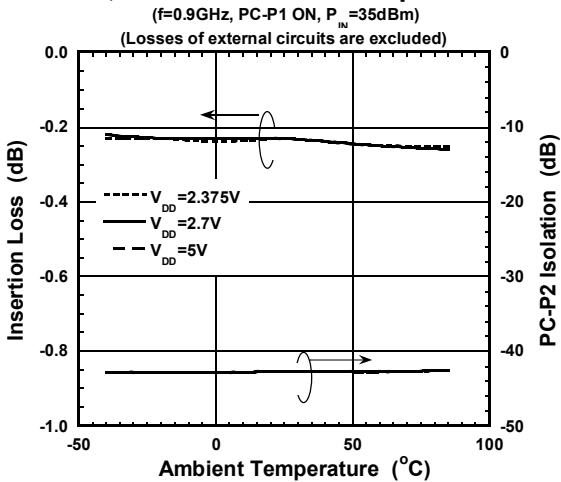

Loss, ISL vs Ambient Temperature

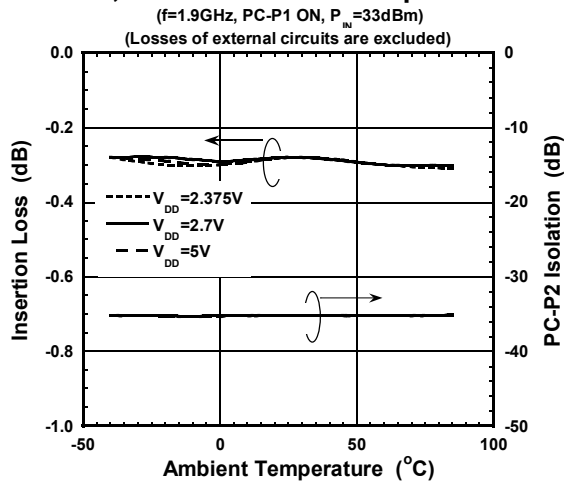

Loss, ISL vs Ambient Temperature

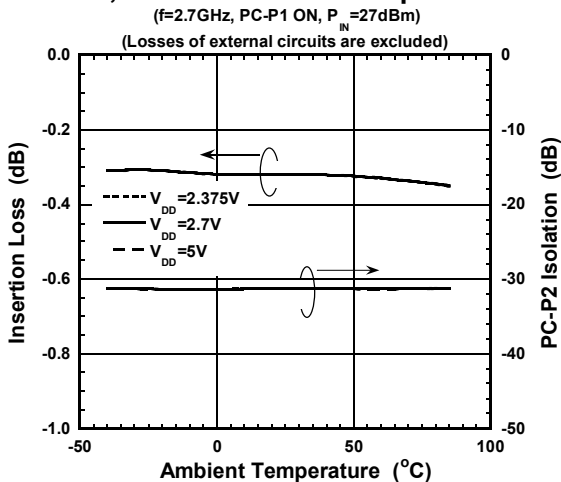

DC Current vs Ambient Temperature

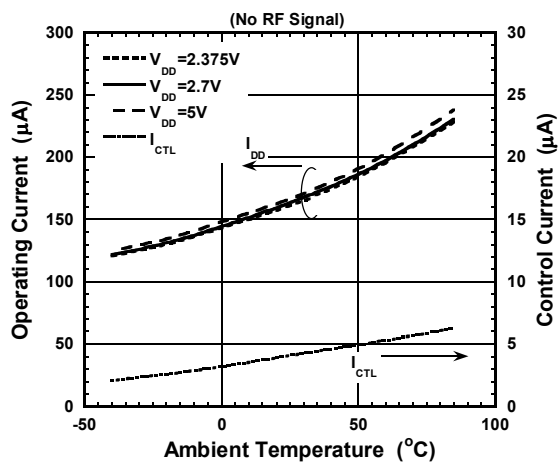

Switching Time vs Ambient Temperature

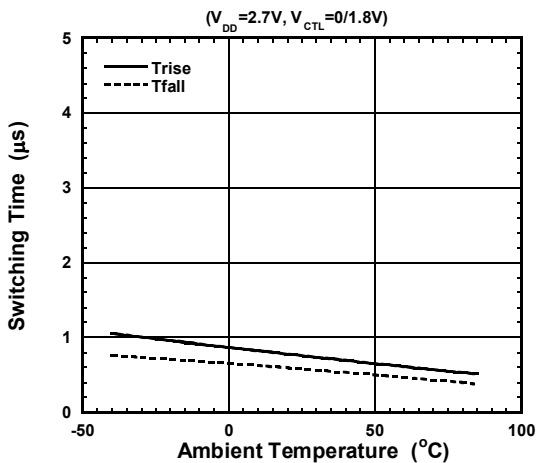

APPLICATION CIRCUIT

(TOP VIEW)

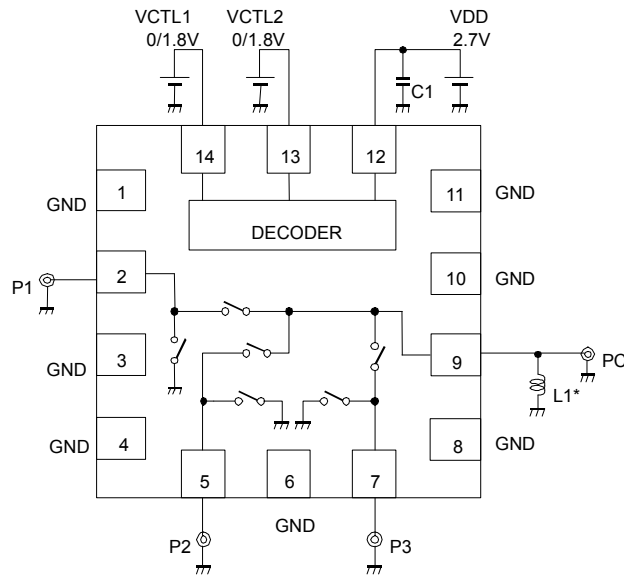

* The Inductor L1 is required for enhancing ESD protection level.

No DC blocking capacitors are required on all RF ports, unless DC is biased externally.

PARTS LIST

No.	Parameters	Note
C1	1000pF	MURATA(GRM15)
L1	68nH	TAIYO-YUDEN (HK1005)

PCB LAYOUT

(TOP VIEW)

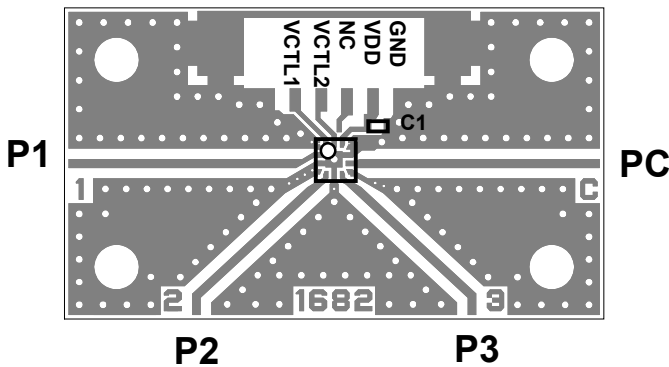

PCB size: 26.0 x 15.0 mm
 PCB: FR-4, t=0.2mm
 Capacitor size: 1005
 Microstrip line width: 0.38mm

Losses of PCB and connectors, Ta=+25°C



Path	Frequency (GHz)	Loss (dB)
PC-P1	0.9	0.18
	1.9	0.34
	2.7	0.42
PC-P2 PC-P3	0.9	0.17
	1.9	0.32
	2.7	0.40

PRECAUTIONS

- [1] No DC blocking capacitors are required at each RF port normally. When the other device is biased at certain voltage and connected to the NJG1682MD7, a DC block capacitor is required between the device and the switch IC. This is because the each RF port of NJG1682MD7 is biased at 0 V (GND).
- [2] For avoiding the degradation of RF performance, the bypass capacitor (C1) should be placed as close as possible to VDD terminal
- [3] For good RF performance, all GND terminals are must be connected to PCB ground plane of substrate, and through - holes for GND should be placed the IC near.

NJG1682MD7

RECOMMENDED FOOTPRINT PATTERN (EQFN14-D7 PACKAGE Reference)

-  :Land
-  :Mask (Open area) *Metal mask thickness : 100um
-  :Resist(Open area)

PKG: 1.6mm x 1.6mm
Pin pitch: 0.4mm

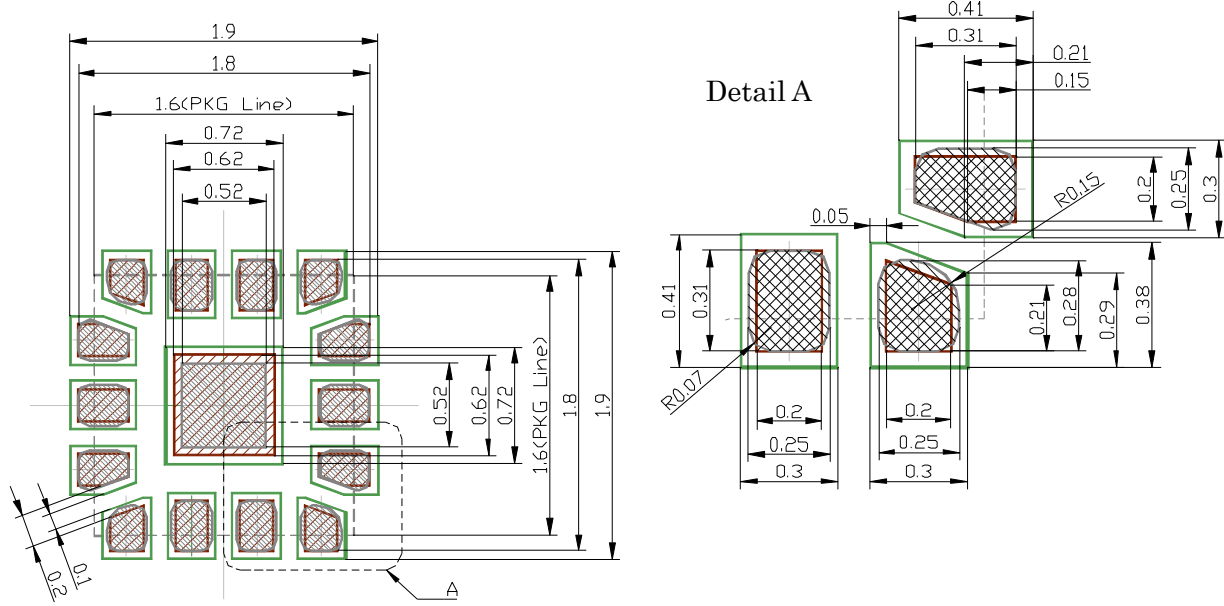

■ PACKAGE OUTLINE (EQFN14-D7)

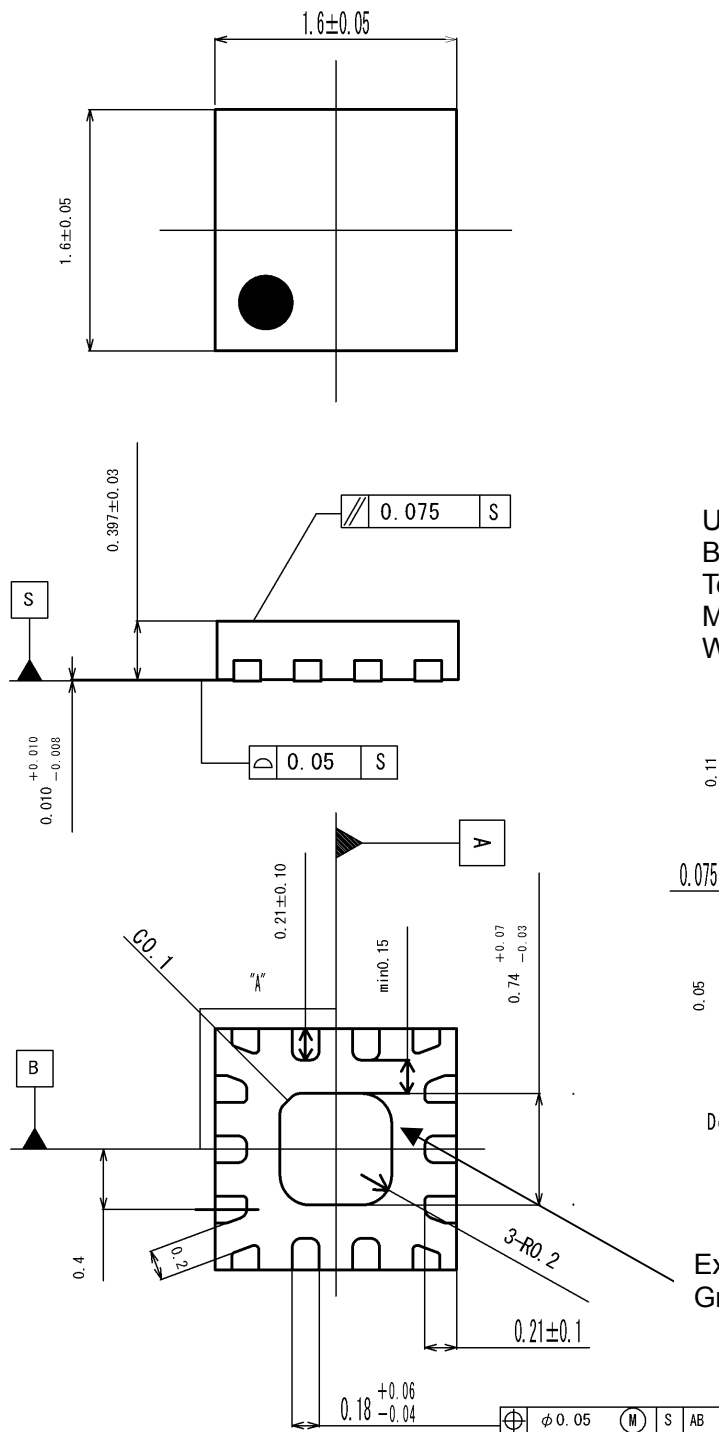

Units	: mm
Board	: Cu
Terminal treat	: SnBi
Molding material	: Epoxy resin
Weight	: 3.4mg

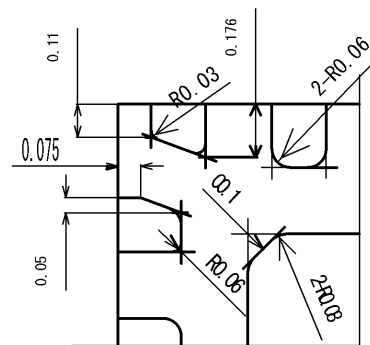

Details of "A" part (× 2)

Exposed PAD
Ground connection is required.

Cautions on using this product

This product contains Gallium-Arsenide (GaAs) which is a harmful material.

- Do NOT eat or put into mouth.
- Do NOT dispose in fire or break up this product.
- Do NOT chemically make gas or powder with this product.
- To waste this product, please obey the relating law of your country.

[CAUTION]

The specifications on this databook are only given for information, without any guarantee as regards either mistakes or omissions. The application circuits in this databook are described only to show representative usages of the product and not intended for the guarantee or permission of any right including the industrial rights.

This product may be damaged with electric static discharge (ESD) or spike voltage. Please handle with care to avoid these damages.