

# New JRC SAW FILTER

## NSNJ2021

Application

**New Zealand AMR f0=924.5MHz BW=5MHz**

Electrical Specification: (Table 1)

The device characteristics are measured in the circuit shown in Fig.1.

Item		Spec.	Typical @25°C
Input and Output Impedance		-	50Ω
Nominal Center Frequency (f0)		-	924.5MHz
Insertion Loss	922~927MHz	3.0dB max.	2.4dB
Response Variation		1.5dB max.	0.5dB
Input and Output VSWR		2.3 max.	1.5
Out of Band Rejection (Relative to Through Level)	500~800MHz	40dB min.	58dB
	800~880MHz	40dB min.	46dB
	880~900MHz	35dB min.	47dB
	900~912MHz	10dB min.	22dB
	935~950MHz	3dB min.	10dB
	950~1500MHz	27dB min.	30dB

Operating Temperature Range -20~+85°C

Maximum Rating: (Table 2)

Table 2. Maximum Ratings

Item	Rating
Maximum Input Power	+20dBm (CW , 1000Hr , Ta=+85°C)
Maximum DC Voltage	7.5V
Operating Temperature Limit	-20~+85°C
Storage Temperature Limit	-30~+85°C

Mechanical Specifications: (Fig.2)

Package is designed as small as 2.0x1.6x0.65[mm<sup>3</sup>] for SMD (Surface Mount Device) type.

**Notice:**

This part is electrostatic discharge sensitive and may be damaged by improper handling.

*New Japan Radio Co., Ltd.*

<http://www.njr.co.jp> (Japanese)

<http://www.njr.com> (English)

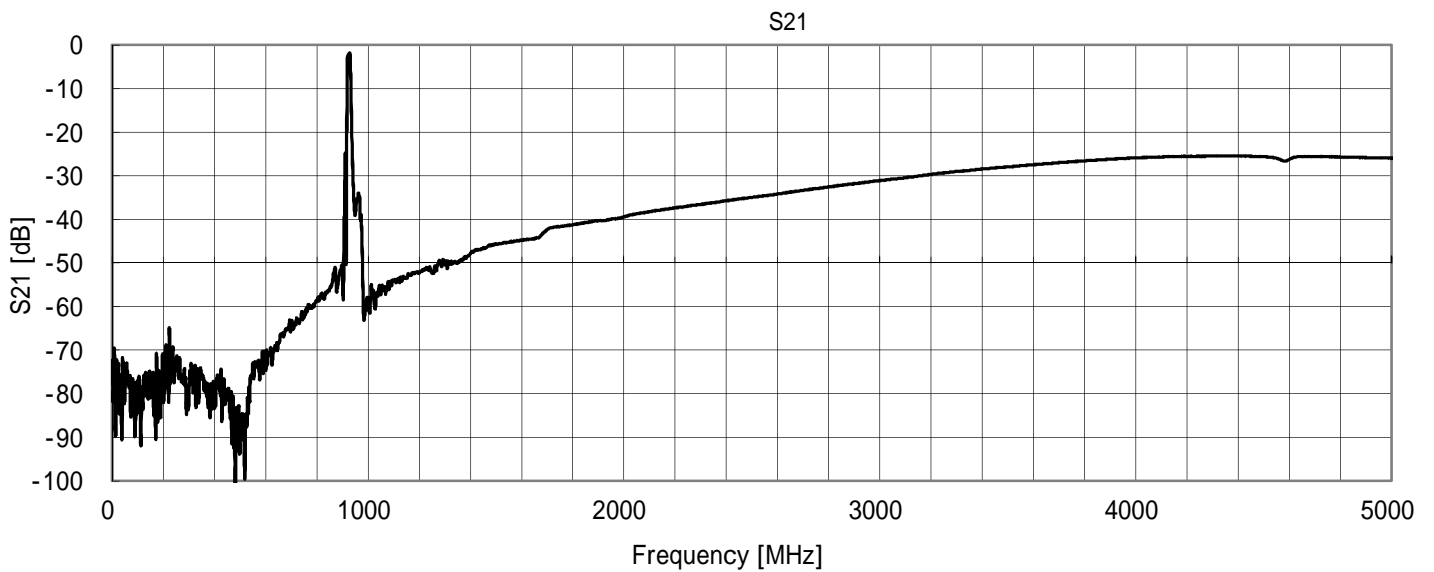
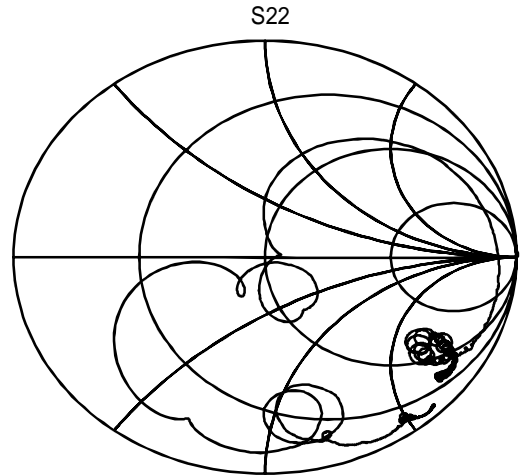
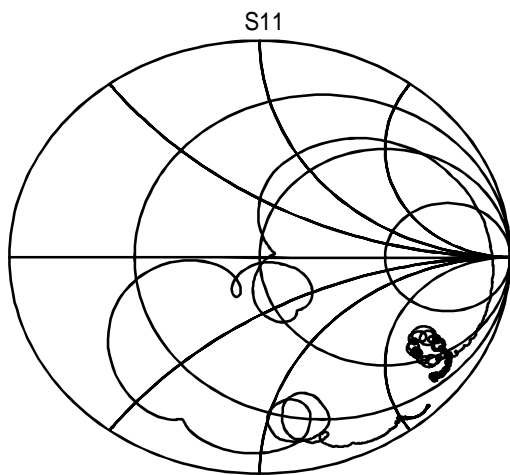
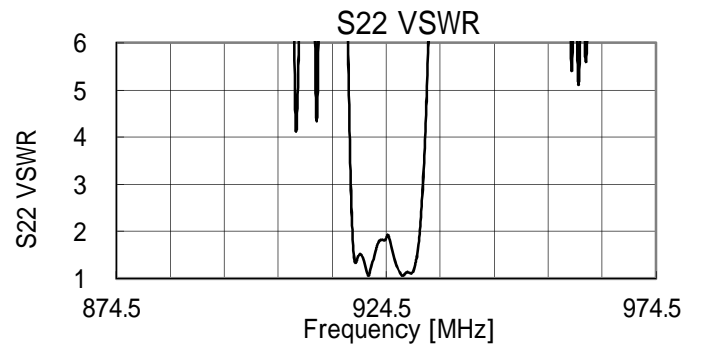
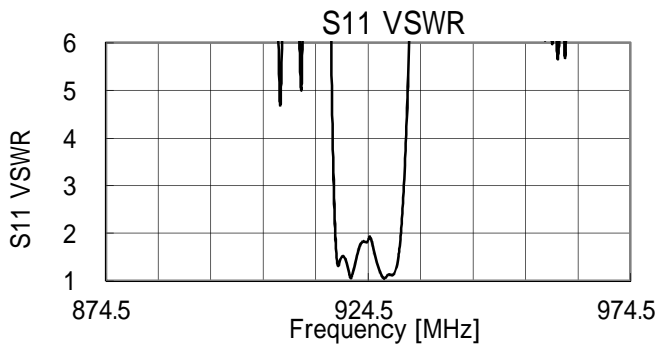
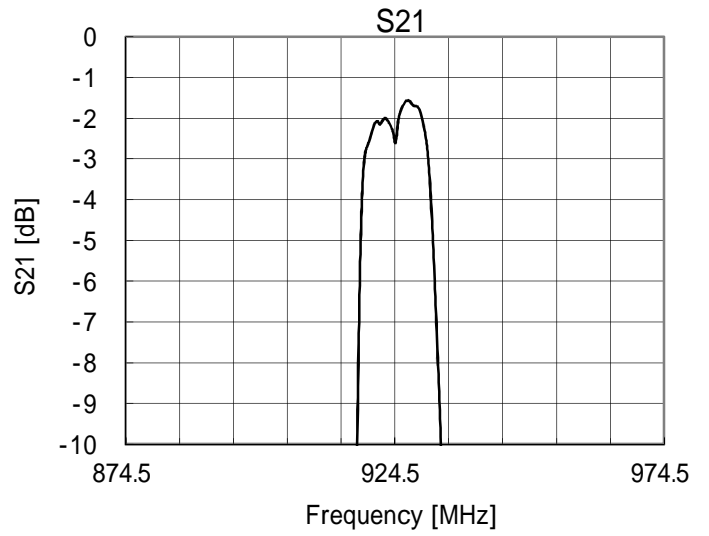
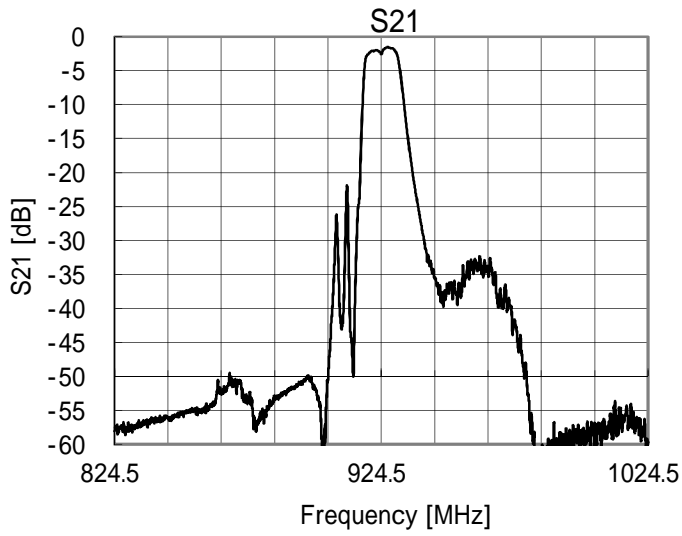

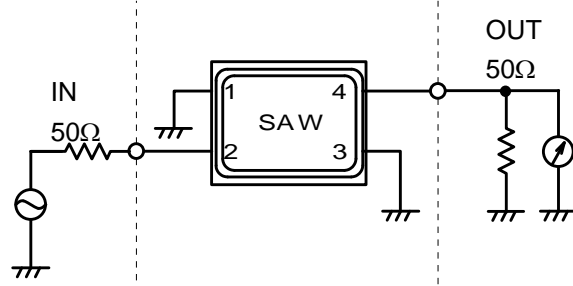

Fig.1 Measuring circuit

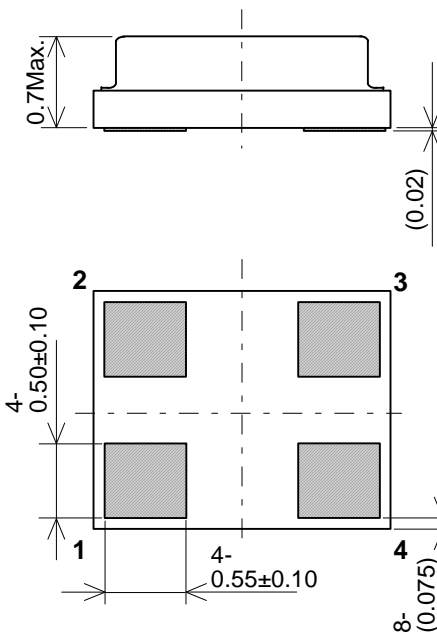
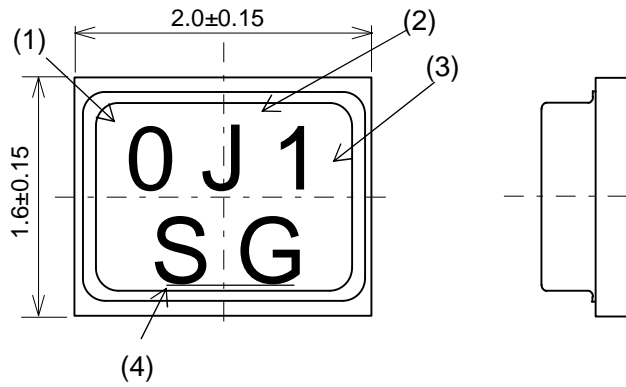

Fig.2 Package dimensions (in mm)

Marking

(1) Year

(2) Month

Jan.~Aug.--- A~H

Sep.--- J

Oct.--- K

Nov.--- L

Dec.--- M

(3) Lot

(4) Part Number Mark

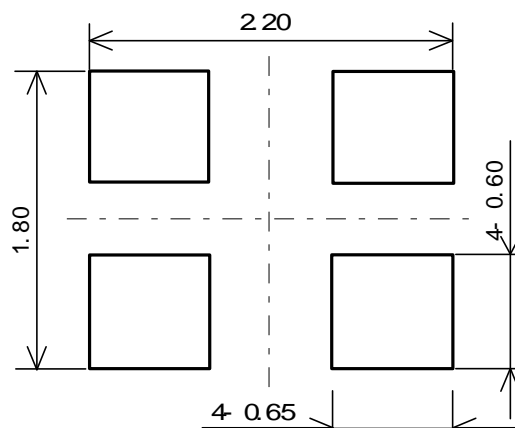

Fig.3 Desirable land area (in mm)

Pin no.	Connection
1	GND
2	IN
3	GND
4	OUT

**Notice**

1. Use this component within operating temperature range. It might not be satisfied with electrical specification without operating temperature range. When it is used less than  $-20^{\circ}\text{C}$  or more than  $+85^{\circ}\text{C}$ , it might be a cause of degradation or destruction of the component. Even if it endures during a short time, it causes degradation of qualification.
2. When soldering iron is used, solder with the temperature at the tip of soldering iron:  $350^{\circ}\text{C}$  max., the time of soldering: 10 seconds max., the power of soldering iron: 30W max..
3. Notice that the allowed time of soldering with soldering iron is accumulated time, when soldering is repeated.
4. As rapid temperature change for cleaning after reflow soldering might be a cause of destruction clean this component after confirming that temperature of this component goes down to room temperature.
5. Confirm that there are not any influence for qualification to this component in mounting on PCB when this component is cleaned.
6. As it might be a cause of degradation or destruction to apply static electricity to this component, do not apply static electricity or excessive voltage while assembling and measuring. And do not transport this component with bare hand.
7. As it might be a cause of degradation or destruction to apply D.C. voltage between each terminal, apply D.C. voltage 7.5V max. in actual circuit.

**Note**

1. This specification specifies the quality of this component as a single unit. Make sure that this component is evaluated and confirmed against this specification when it is mounted to your products.
2. The information contained herein may be changed without prior notice. It is therefore advisable to contact New Japan Radio Company before proceeding with the design of equipment incorporating this product.
3. The products are designed to be used with ordinary electronic equipment (data and communications equipment, office equipment, audio-video equipment, measuring instruments, etc). New Japan Radio Company does not assume any liability for the case using the products with the application required high reliability or safety extremely (such as space equipment, sea-bottom equipment, medical equipment etc). When intending to use any our product please contact our sales representatives in advance.