

Designated client product

This product will be discontinued its production in the near term.
And it is provided for customers currently in use only, with a time limit.
It can not be available for your new project. Please select other new or existing products.

For more information, please contact our sales office in your region.

New Japan Radio Co.,Ltd.

<http://www.njr.com/>

Low Dropout Voltage Regulator with Reset

GENERAL DISCRIPTION

The NJM2800 is a low dropout voltage regulator with reset function.

It provides up to 150mA of logic supply, and the reset function monitors input voltage of the regulator with 1% accuracy.

It is suitable for local power supply and reset for small micro controller and other logic chips.

PACKAGE OUTLINE

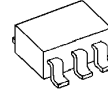

NJM2800F



NJM2800U/U1

FEATURES

- Output Voltage Accuracy $V_o = \pm 1.0\%$
- Reset Voltage Accuracy $V_{RT} = \pm 1.0\%$
- Adjust reset delay time with external capacitor.
- Ripple Rejection 60dB typ. (f=1kHz)
- Input Voltage Monitor type
- Open Collector Output
- Internal Short Circuit Current Limit
- Internal Thermal Overload Protection
- Bipolar Technology
- Package Outline SOT89-5 (NJM2800U/U1), SOT-23-5(NJU2800F)

PIN CONFIGURATION

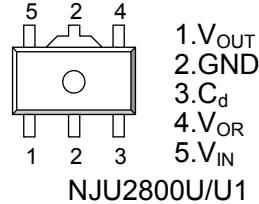
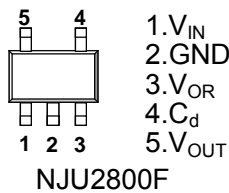

OUTPUT VOLTAGE/ DETECTION VOLTAGE

Device Name	Output Voltage	Detection Voltage
NJM2800U1-/U/F1803	1.8V	3.0V
NJM2800U1-/F2528	2.5V	2.8V
NJM2800U1-/U/F3342	3.3V	4.2V

EQUIVALENT CIRCUIT

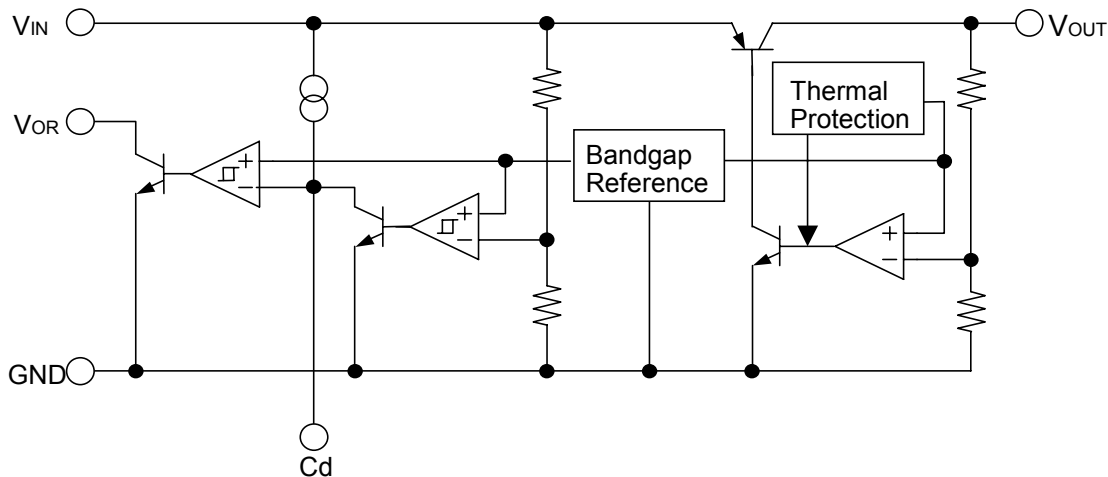

■ ABSOLUTE MAXIMUM RATINGS (Ta=25°C)

PARAMETER	SYMBOL	RATINGS	UNIT	
Input Voltage	V _{IN}	+14	V	
Power Dissipation	P _D	SOT-23-5	350(*1)	mW
			200(*2)	
		SOT89-5	350(*2)	
Operating Temperature	Topr	-40~+85	°C	
Storage Temperature	Tstg	-40~+125	°C	

(*1): Mounted on glass epoxy board based on EIA/JEDEC. (114.3x76.2x1.6mm: 2Layers)

(*2): Device itself.

■ Operating voltage

V_{IN}=+2.3 ~ +14V (In case of Vo<2.1V version)

■ ELECTRICAL CHARACTERISTICS

(V_{IN}=Vo+1V, C_{IN}=0.1μF, Co=1μF (1.8<Vo≤2.6V: Co=2.2μF, Vo≤1.8V: Co=4.7μF), Ta=25°C)

PARAMETER	SYMBOL	TEST CONDITION	MIN.	TYP.	MAX.	UNIT
Quiescent Current	I _Q	V _{IN} =Vo+2V, I _o =0mA	-	250	350	μA
Regulator Block						
Output Voltage	V _o	I _o =30mA	-1.0%	-	+1.0%	V
Output Current	I _o	V _o -0.3V	150	200	-	mA
Line Regulation	ΔV _o /ΔV _{IN}	V _{IN} =Vo+1V~Vo+6V, I _o =30mA	-	-	0.10	%/V
Load Regulation	ΔV _o /ΔI _o	I _o =0~100mA	-	-	0.03	%/mA
Dropout Voltage(*3)	ΔV _{L_O}	I _o =60mA	-	0.10	0.18	V
Ripple Rejection	RR	e _{in} =200mVrms, f=1kHz, I _o =10mA, V _o =3V Version	-	60	-	dB
Output Voltage Temperature Coefficient	ΔV _o /ΔT	Ta=0~85°C, I _o =10mA	-	±50	-	ppm/°C
Output Noise Voltage	V _{NO}	f=10Hz~100kHz, I _o =10mA, V _o =3V Version	-	45	-	μVrms
Reset Block						
Voltage Detection	V _{RT}	V _{IN} =H→L	-1.0%	-	+1.0%	V
Hysteresis Voltage	V _{RTH}	V _{IN} =H→L→H	V _{RT} ×3%	V _{RT} ×5%	V _{RT} ×8%	V
Low Level Output	R _{ORL}	V _{IN} =V _{RT} -0.5V, R _L =100kΩ	-	100	300	mV
Output Leak Current	I _{ORH}	V _{IN} =V _{RT} +0.5V	-	-	0.1	μA
On time Output Current	I _{ORL}	V _{IN} =V _{RT} -0.5V, R _L =0Ω	5	-	-	mA
Reset Output Delay	t _d	V _{IN} =(V _{RT} -0.5V)→(V _{RT} +0.5V), C _d =0.1μF	9	10	11	ms
Operation Voltage Limit	V _{OPL}	V _{ORL} =0.4V	-	0.9	-	V

(*3): The output voltage excludes under 2.1V.

The above specification is a common specification for all output voltages.

Therefore, it may be different from the individual specification for a specific output voltage.

■ TIMING CHART

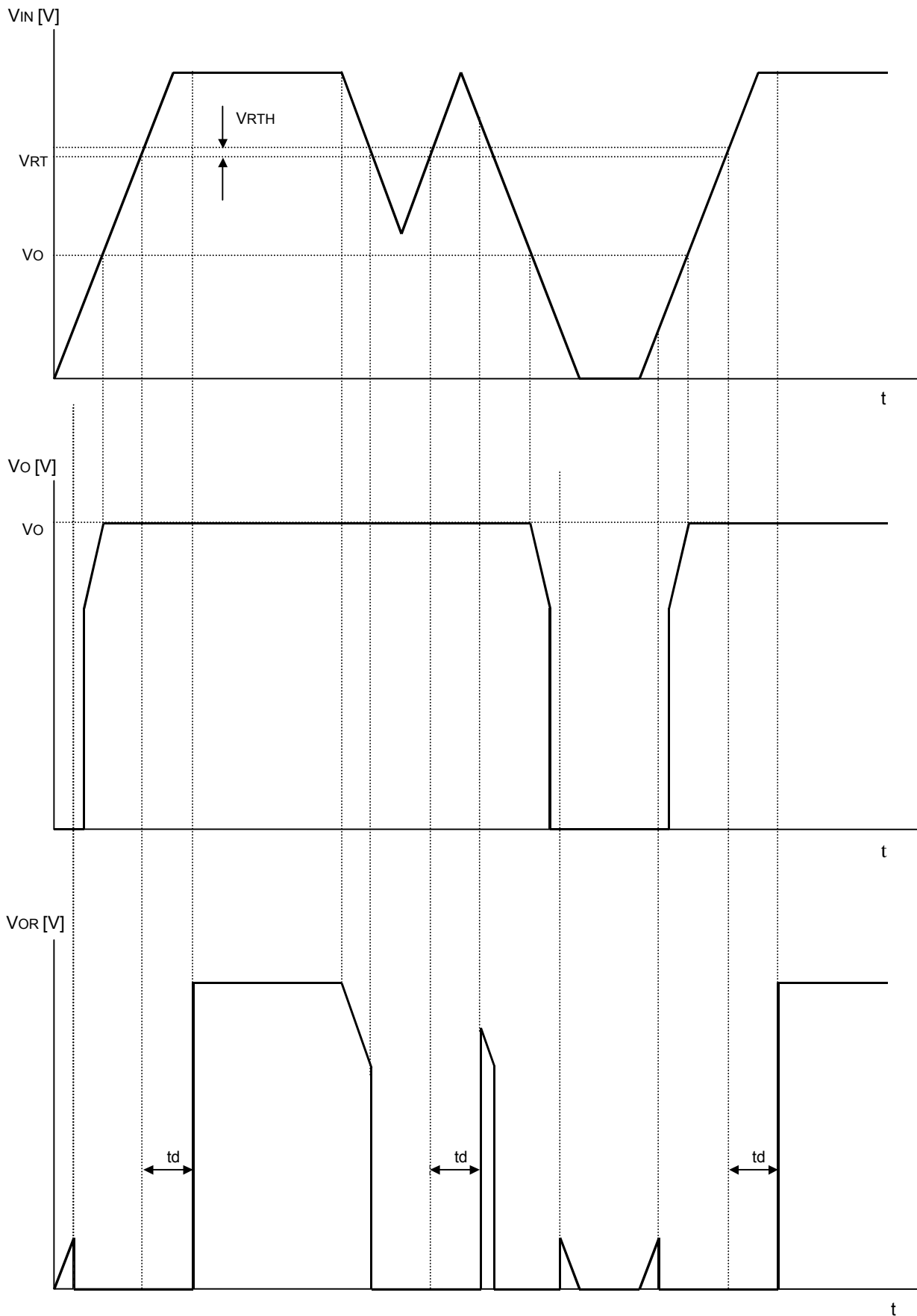

* V_{OR} is the case where a pull-up is carried out to V_{IN} through resistance.

■ TEST CIRCUIT

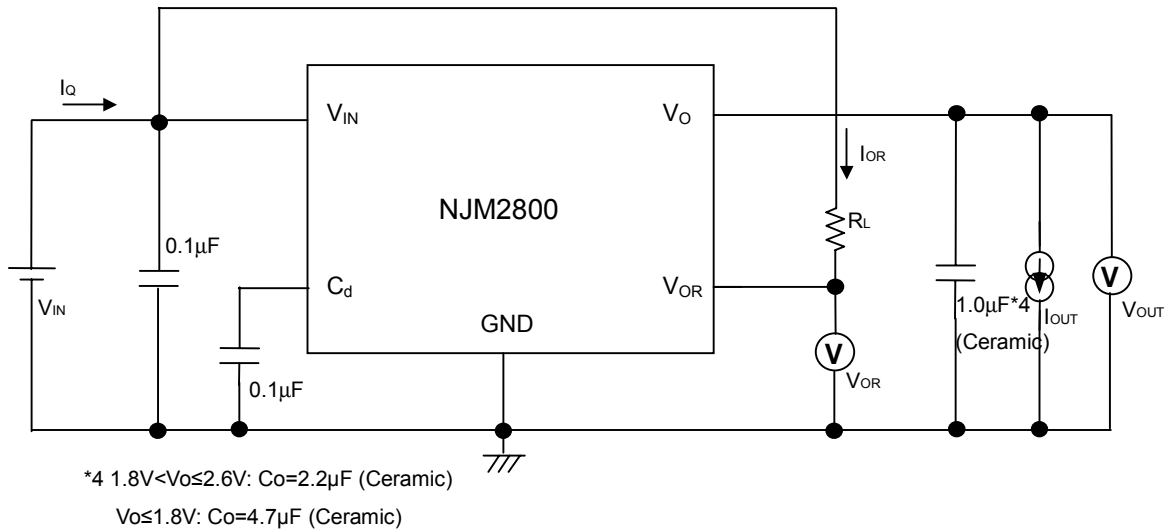

■ TYPICAL APPLICATIONS

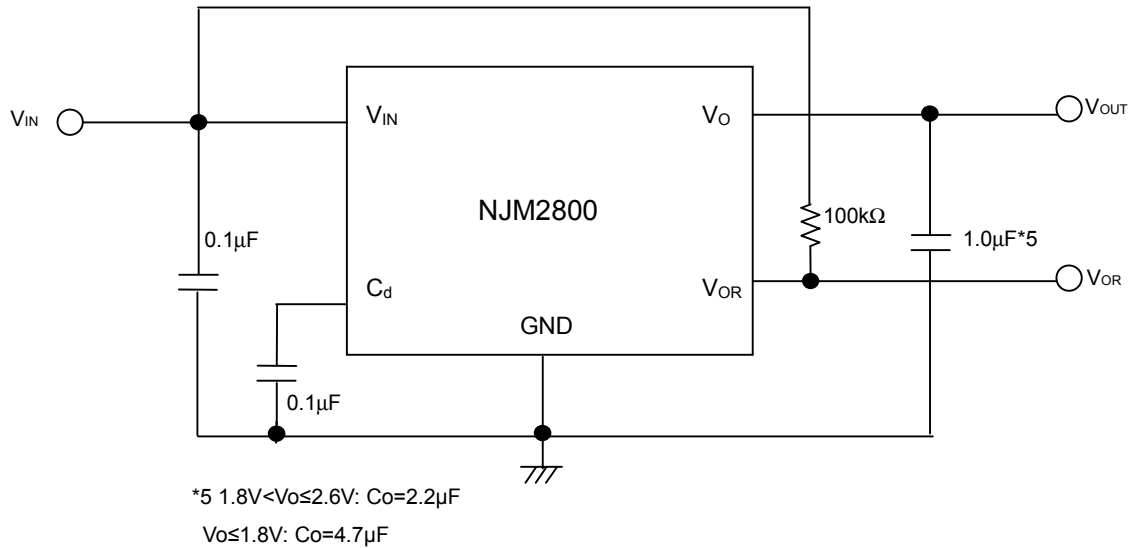

■ POWER DISSIPATION vs. AMBIENT TEMPERATURE

NJM2800F Power Dissipation
 ($T_{op} = -40 \sim +85^\circ C$, $T_j = 125^\circ C$)

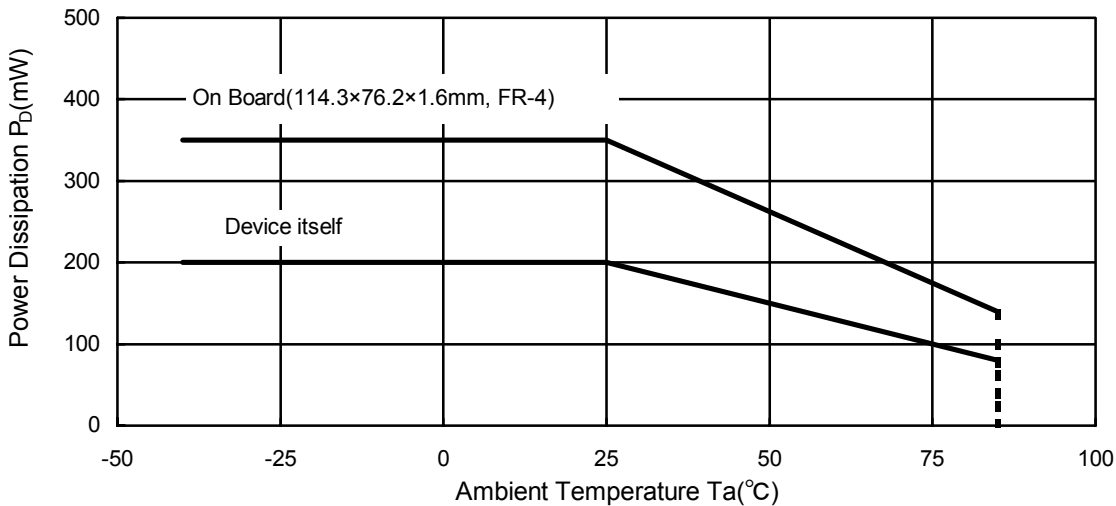

■ ELECTRICAL CHARACTERISTICS

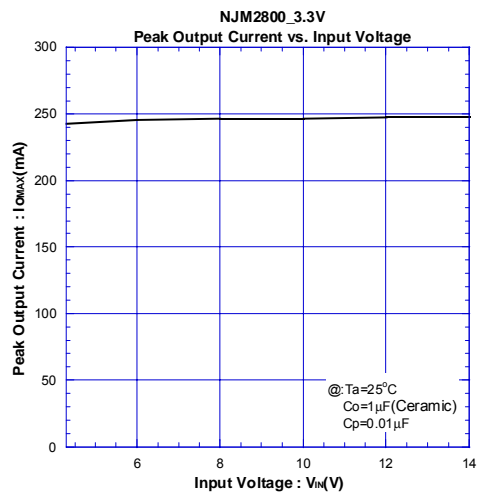
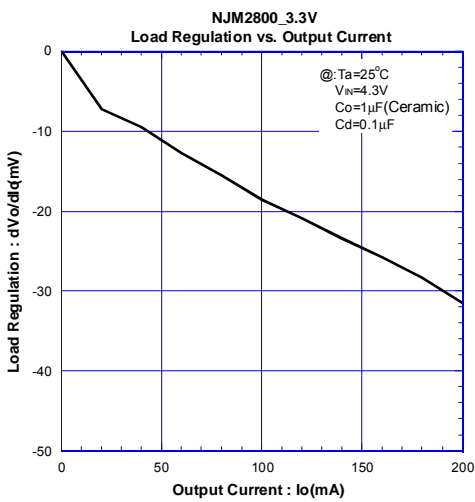
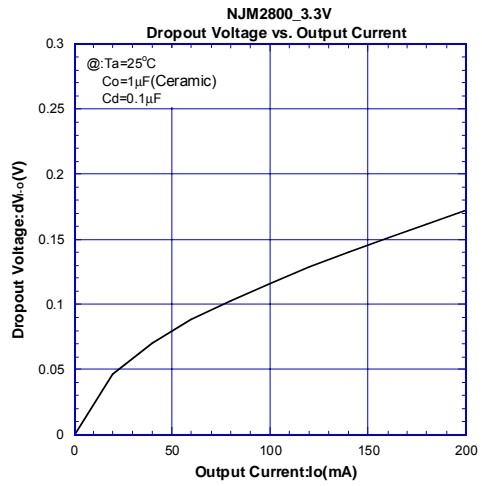
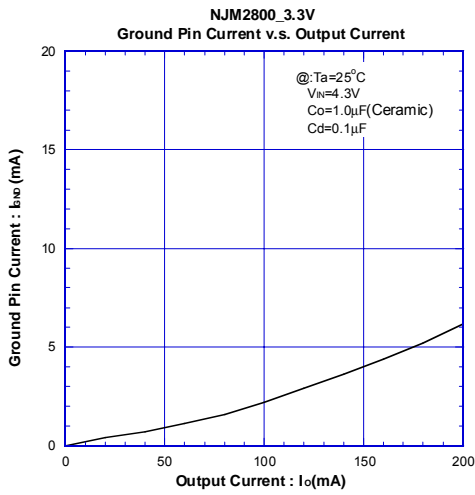
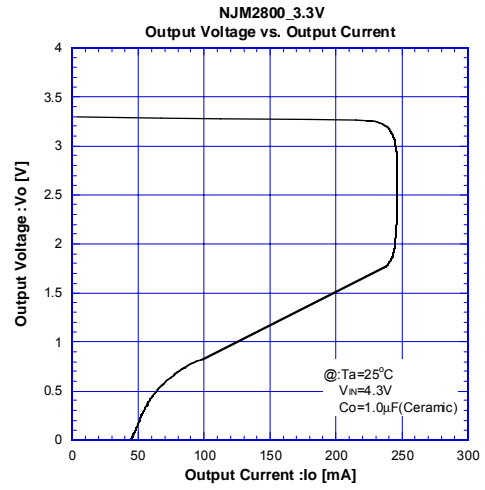
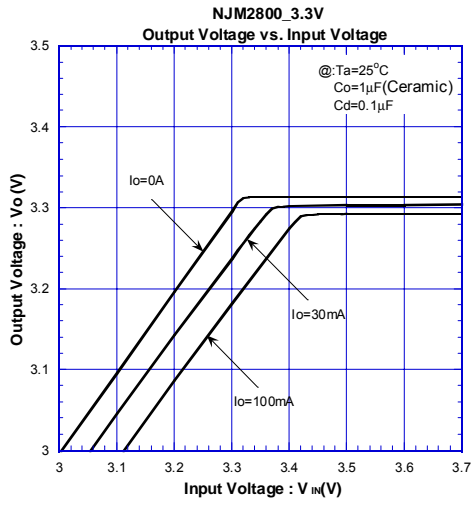

■ ELECTRICAL CHARACTERISTICS

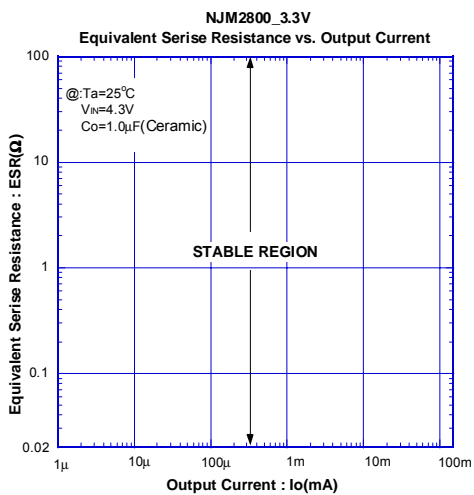
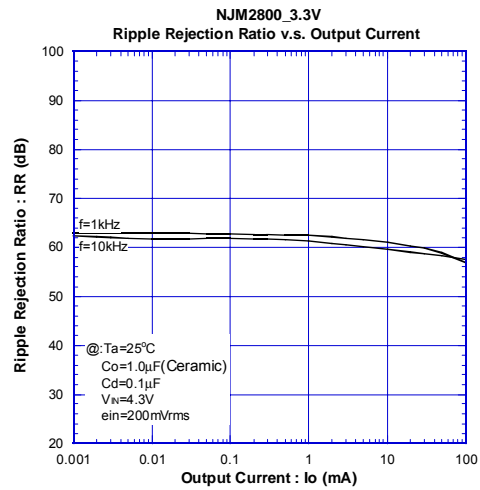
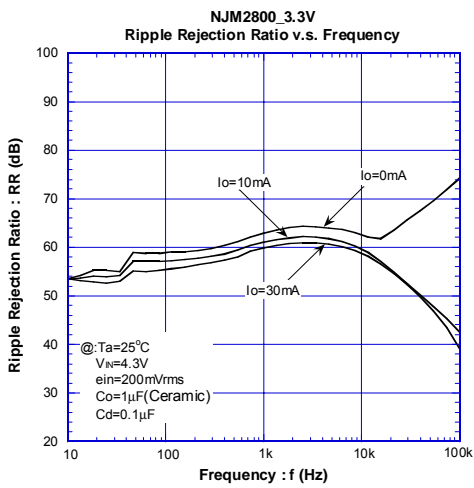
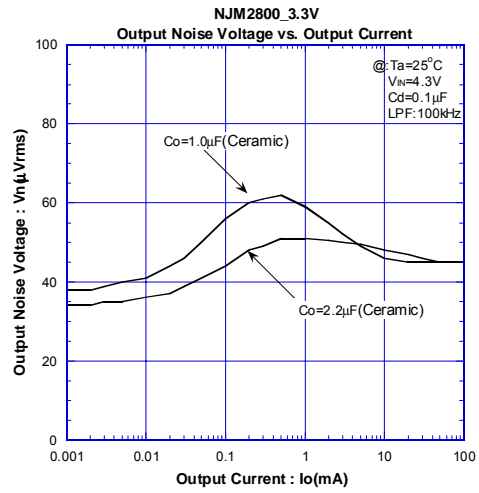
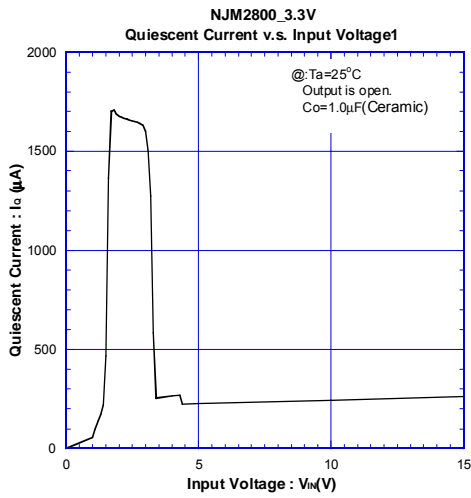

■ ELECTRICAL CHARACTERISTICS

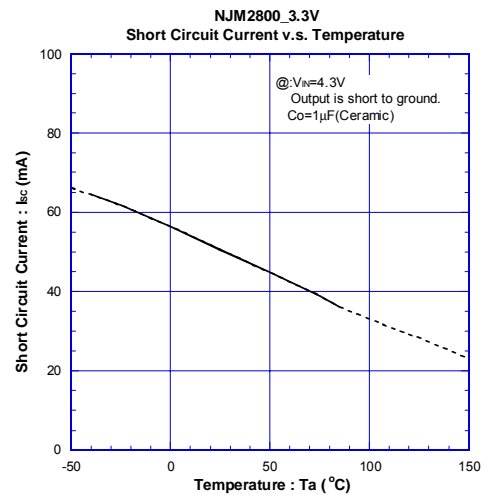
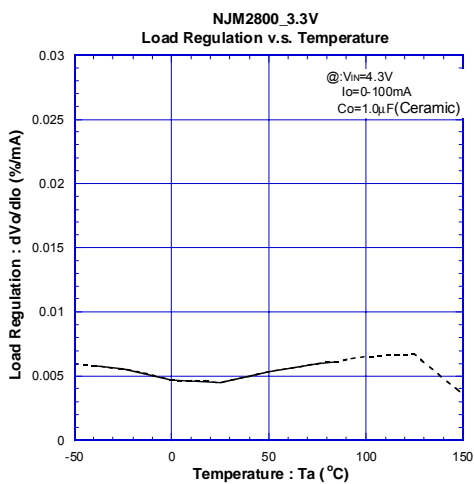
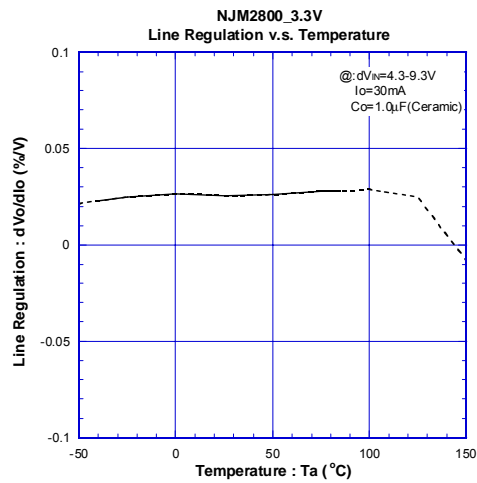
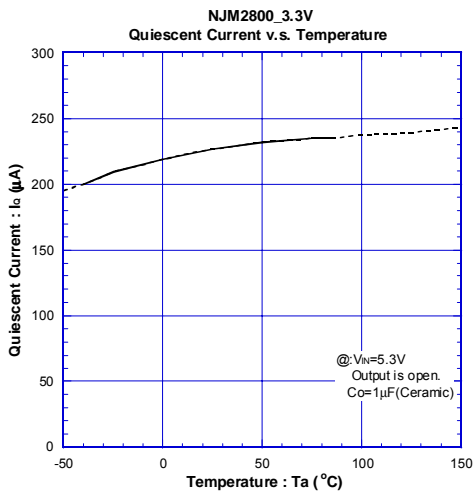
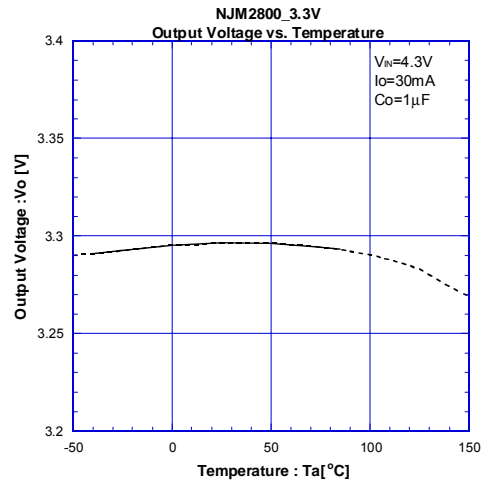
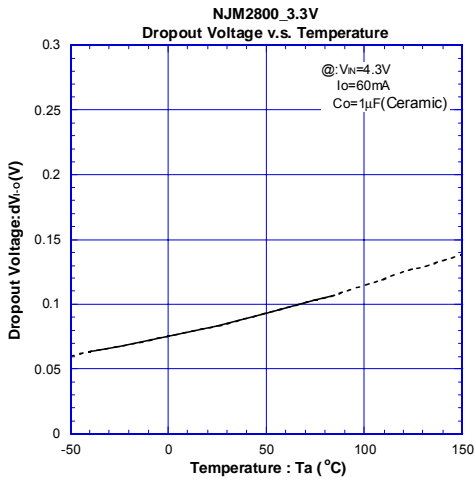

ELECTRICAL CHARACTERISTICS

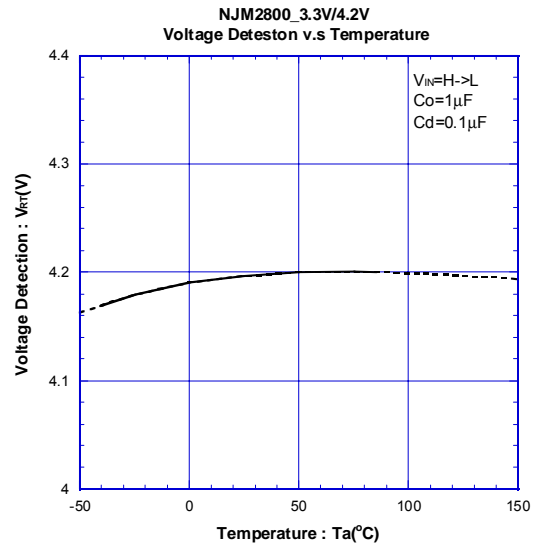
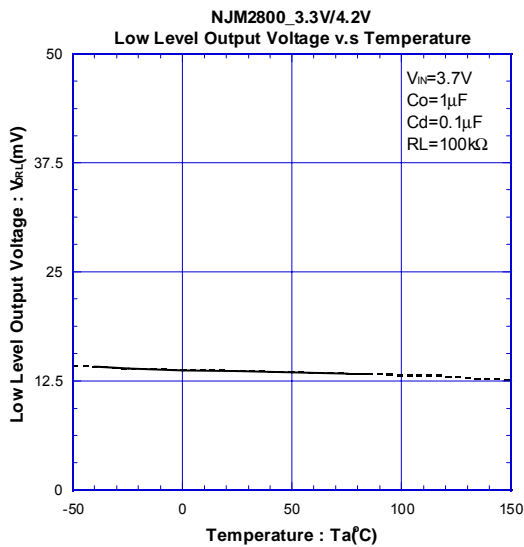
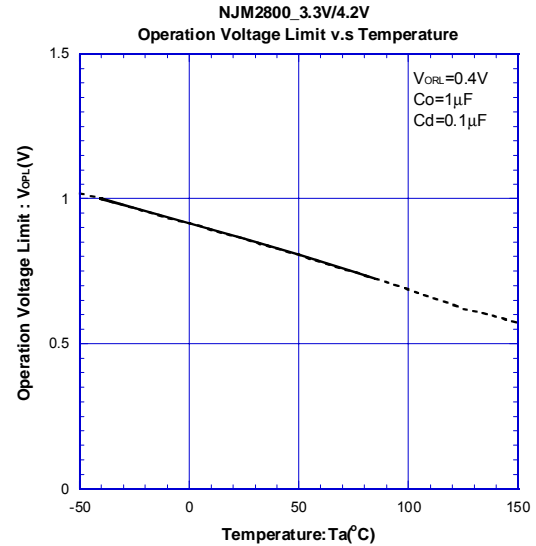
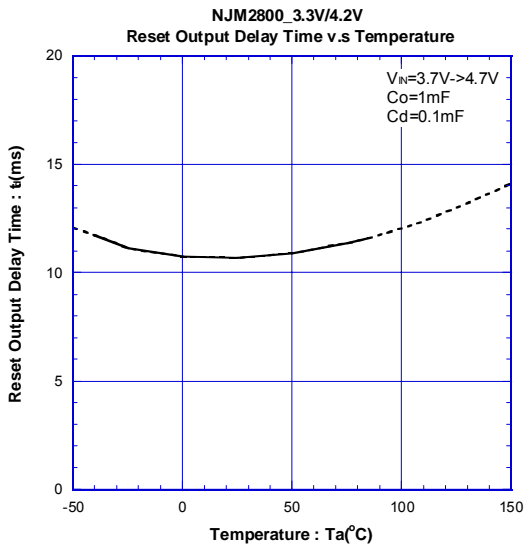
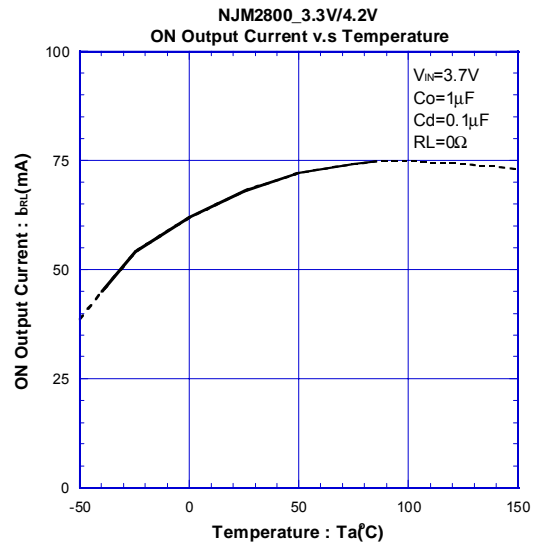
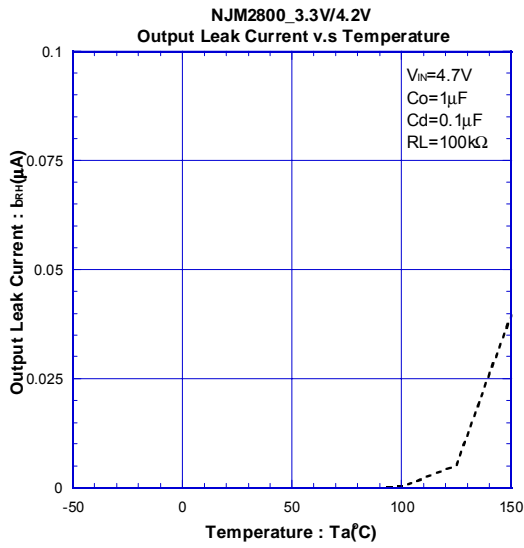

■ ELECTRICAL CHARACTERISTICS

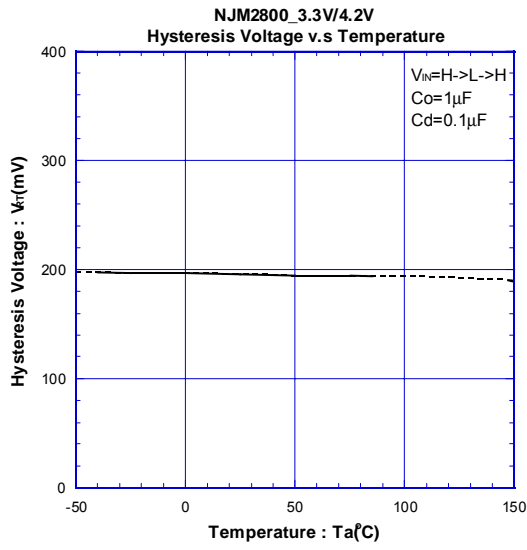

[CAUTION]

The specifications on this databook are only given for information, without any guarantee as regards either mistakes or omissions. The application circuits in this databook are described only to show representative usages of the product and not intended for the guarantee or permission of any right including the industrial rights.