Designated client product

This product will be discontinued its production in the near term.
And it is provided for customers currently in use only, with a time limit.
It can not be available for your new project. Please select other new or existing products.

For more information, please contact our sales office in your region.

New Japan Radio Co.,Ltd.

www.njr.com

ADJUSTABLE LOW DROPOUT VOLTAGE REGULATOR

■ GENERAL DESCRIPTION

The NJM2397 is adjustable low dropout voltage regulator. The output current is up to 1.5A and dropout voltage is 0.2Vtyp. at $I_o=0.5A$.

The NJM2397 is suitable for power module, TV, Display, car stereo and low power applications.

■ FEATURE

- Low Dropout Voltage $\Delta V_{I-O}=0.2V$ typ. at $I_o=0.5A$
- Output Current $I_o(max.)=1.5A$
- Reference Voltage $V_{ref}=1.29V$ typ.
- Internal Short Circuit Current Limit
- Internal Overvoltage Protection
- Internal Thermal Overload Protection
- Bipolar Technology
- Package Outline TO-220F(4pin)

■ PACKAGE OUTLINE

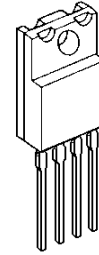

NJM2397F

■ PIN CONFIGURATION

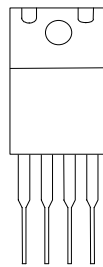

1 2 3 4

NJM2397F

PIN FUNCTION

1. V_{IN}
2. V_{OUT}
3. GND
4. ADJ

■ EQUIVALENT CIRCUIT

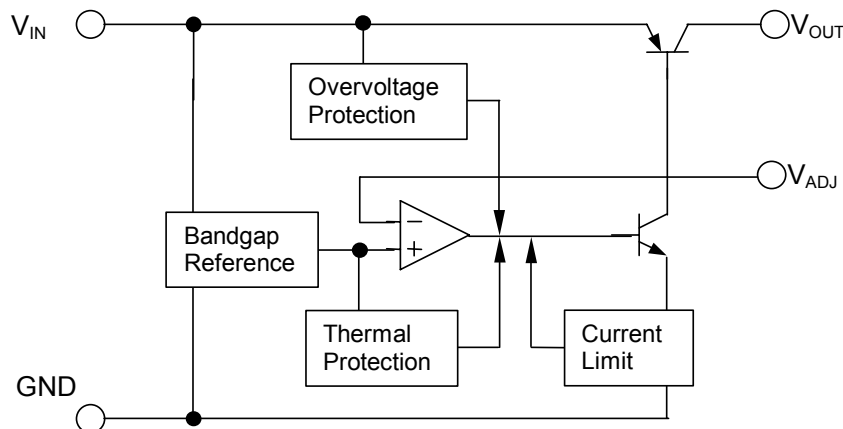

NJM2397

■ ABSOLUTE MAXIMUM RATINGS

(Ta=25°C)

| PARAMETER | SYMBOL | RATINGS | UNIT |
|--------------------------------------|------------------|-------------|------|
| Input Voltage | V _{IN} | +35 | V |
| Adjust terminal Voltage | V _{ADJ} | +6 | V |
| Output Current | I _o | 1.5 | A |
| Power Dissipation | P _D | 18(Tc<50°C) | W |
| Operating Junction Temperature Range | T _j | -40 to +150 | °C |
| Operating Temperature Range | Topr | -40 to 85 | °C |
| Storage Temperature Range | Tstg | -50 to 150 | °C |

■ ELECTRICAL CHARACTERISTICS (V_{IN}=15V, V_o=10V, I_o=0.5A, R₁=1kΩ, C_{IN}=0.33uF, C_o=22uF, T_j=25°C)

Measurement is to be conducted is pulse testing.

| PARAMETER | SYMBOL | CONDITIONS | MIN. | TYP. | MAX. | UNIT |
|---|------------------------------|--|-------|-------|-------|------|
| Input Voltage | V _{IN} | | 3.8 | - | 35 | V |
| Output Voltage | V _o | | 1.5 | - | 20 | V |
| Reference Voltage | V _{ref} | | 1.238 | 1.29 | 1.342 | V |
| Line Regulation | $\Delta V_o / \Delta V_{IN}$ | V _{IN} =V _o +1V~V _o +17V | - | 0.04 | 0.16 | %/V |
| Load Regulation | $\Delta V_o / \Delta I_o$ | V _{IN} =V _o +2V, I _o =0A~1.5A | - | 0.2 | 1.4 | %/A |
| Average Temperature Coefficient of Output Voltage | $\Delta V_o / \Delta T$ | T _j =0~125°C | - | ±0.02 | - | %/°C |
| Quiescent Current | I _Q | I _o =0A | - | - | 5 | mA |
| Dropout Voltage | ΔV_{I_o} | I _o =0.5A | - | 0.2 | 0.5 | V |
| Ripple Rejection | RR | V _{in} =V _o +2V, e _{in} =0.5Vrms, f=120Hz | 45 | 55 | - | dB |

■ TEST CIRCUIT

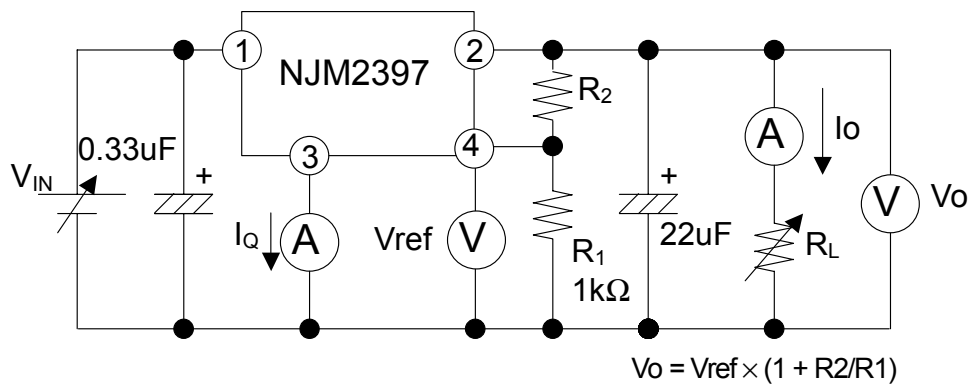

■ TYPICAL CHARACTERISTICS

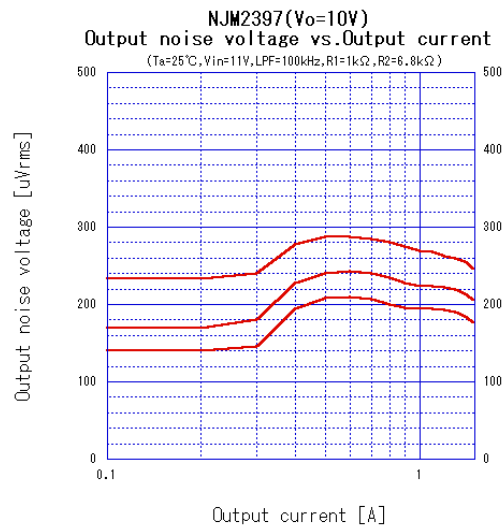
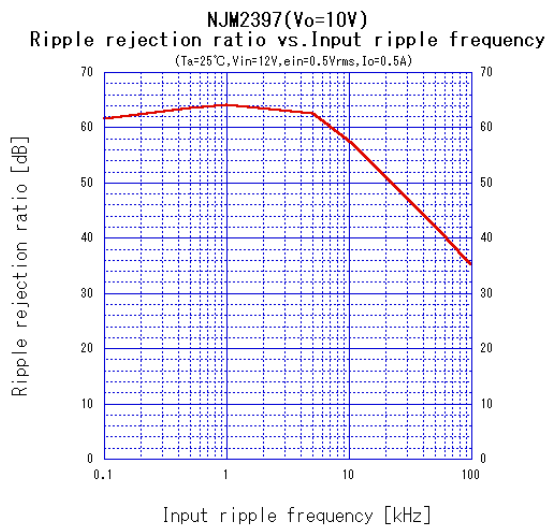
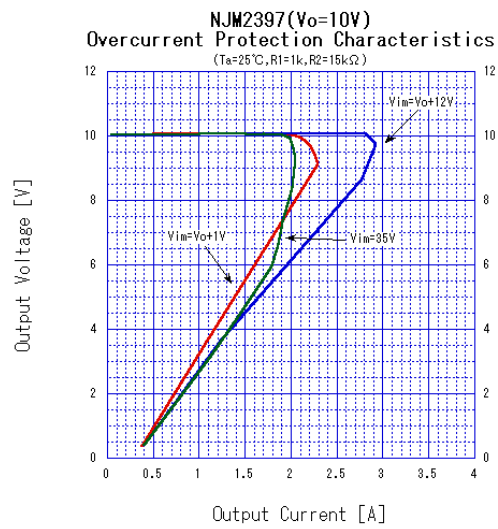
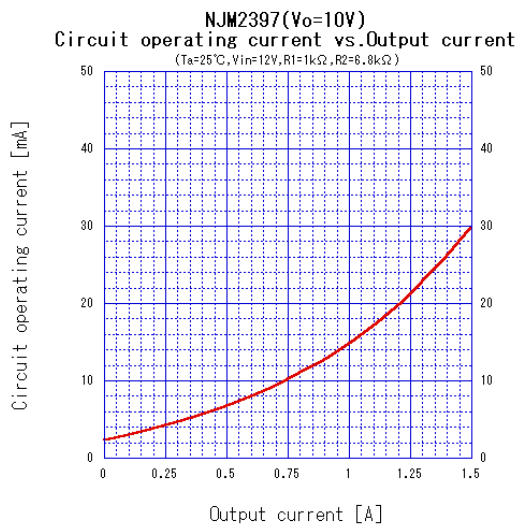
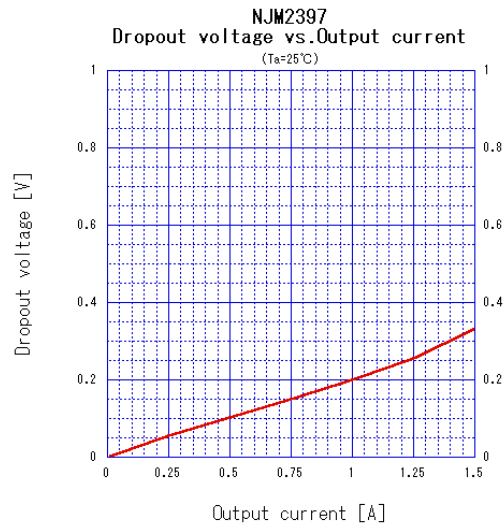
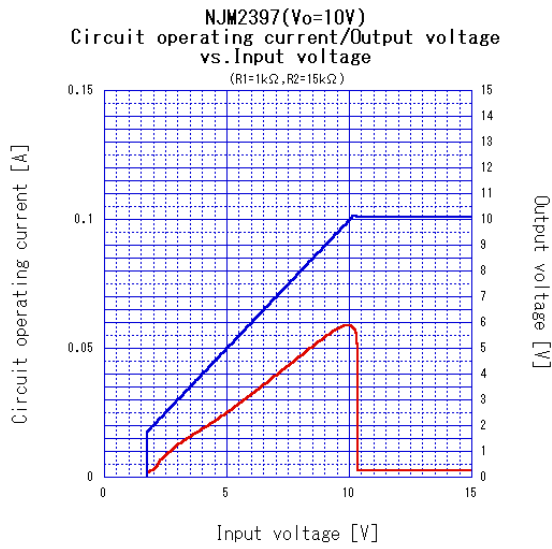

NJM2397

■ TYPICAL CHARACTERISTICS

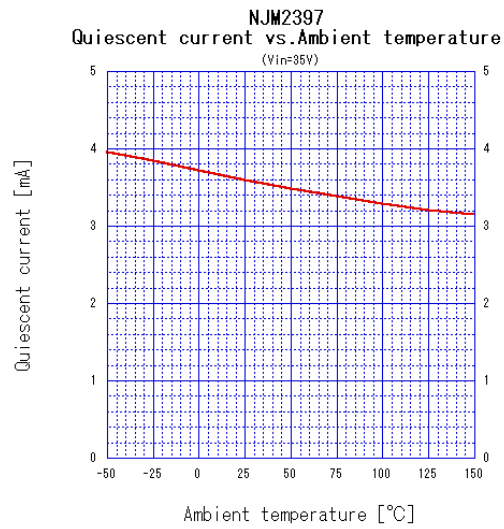
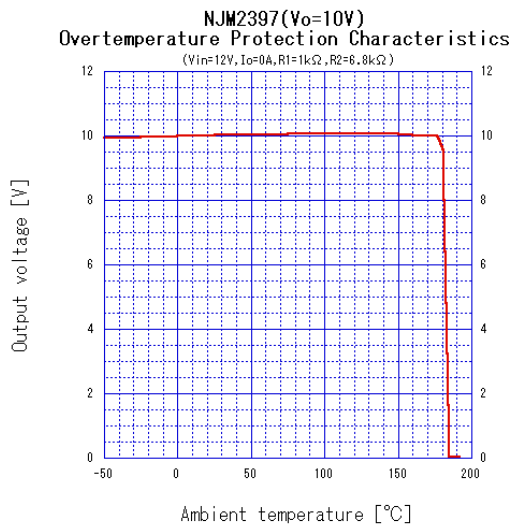
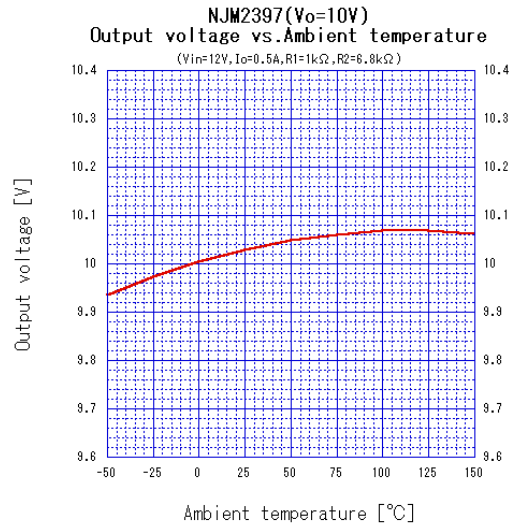
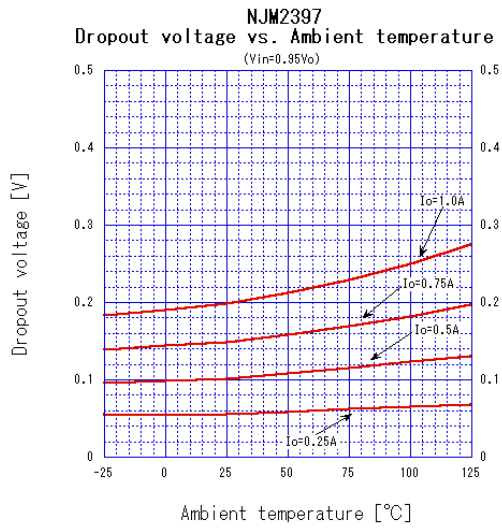

[CAUTION]

The specifications on this databook are only given for information, without any guarantee as regards either mistakes or omissions. The application circuits in this databook are described only to show representative usages of the product and not intended for the guarantee or permission of any right including the industrial rights.