

Designated client product

This product will be discontinued its production in the near term.
And it is provided for customers currently in use only, with a time limit.
It can not be available for your new project. Please select other new or existing products.

For more information, please contact our sales office in your region.

New Japan Radio Co.,Ltd.

www.njr.com

2-INPUT 3CHANNEL VIDEO SWITCH

■ GENERAL DESCRIPTION

NJM2286 is a switching IC for switching over from one audio or video input signal to another. Internalizing 2 inputs, 1 output, and then each set of 3 can be operated independently. They are a Clamp type", and it can be operated while DC level fixed in position of the video signal. It is a higher efficiency video switch, featuring the operating supply voltage 4.75 to 13.0V, the frequency feature 10MHz, and then the Crosstalk 75dB (at 4.43MHz).

■ PACKAGE OUTLINE

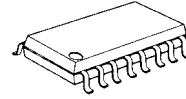

NJM2286M

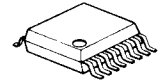

NJM2286V

■ FEATURES

- 2 Input-1 Output Internalizing 3 Circuits (Clamp type).
- Wide Operating Voltage (4.75 to 13.0V)
- Crosstalk 75dB (at 4.43MHz)
- Wide Bandwidth Frequency Feature 10MHz (2V_{P-P} Input)
- Package Outline DMP16, SSOP16
- Bipolar Technology

■ BLOCK DIAGRAM

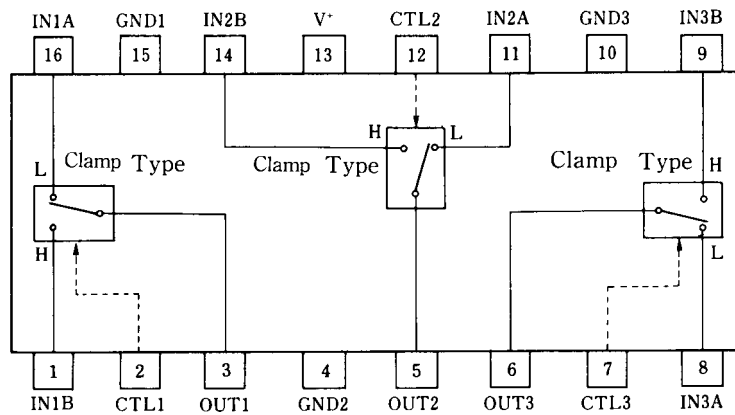

NJM2286V
NJM2286M

NJM2286

■ MAXIMUM RATINGS

(T_a = 25°C)

PARAMETER	SYMBOL	RATINGS	UNIT
Supply Voltage	V ⁺	14	V
Power Dissipation	P _D	(SSOP16) 300 (DMP16) 350	mW mW
Operating Temperature Range	T _{opr}	-40 to +85	°C
Storage Temperature Range	T _{stg}	-40 to +125	°C

■ ELECTRICAL CHARACTERISTICS

(V⁺ = 5V, T_a = 25°C)

PARAMETER	SYMBOL	TEST CONDITION	MIN.	TYP.	MAX.	UNIT
Operating Current (1)	I _{CC1}	V ⁺ = 5V (Note1)	7.9	11.3	14.7	mA
Operating Current (2)	I _{CC2}	V ⁺ = 9V (Note1)	9.8	14.1	18.4	mA
Voltage Gain	G _V	V _I = 100kHz, 2V _{P,P} , V _O / V _I	-0.6	-0.1	+0.4	dB
Frequency Gain	G _F	V _I = 2V _{P,P} , V _O (10MHz) / V _O (100kHz)	-1.0	0	+1.0	dB
Differential Gain	DG	V _I = 2V _{P,P} , Standard Staircase Signal	-	0.3	-	%
Differential Phase	DP	V _I = 2V _{P,P} , Standard Staircase Signal	-	0.3	-	deg
Output Offset Voltage	V _{OS}	(Note2)	-15	0	+15	mV
Crosstalk	CT	V _I = 2V _{P,P} , 4.43MHz, V _O / V _I	-	-75	-	dB
Switch Change Over Voltage	V _{CH}	All inside Switch ON	2.5	-	-	V
Switch Change Over Voltage	V _{CL}	All inside Switch OFF	-	-	1.0	V

(Note1) S1 = S2 = S3 = S4 = S5 = S6 = S7 = 1

(Note2) S1 = S2 = S3 = S4 = S5 = S6 = 1, S7 = 1→2 Measure the output DC voltage difference

■ TEST CIRCUIT

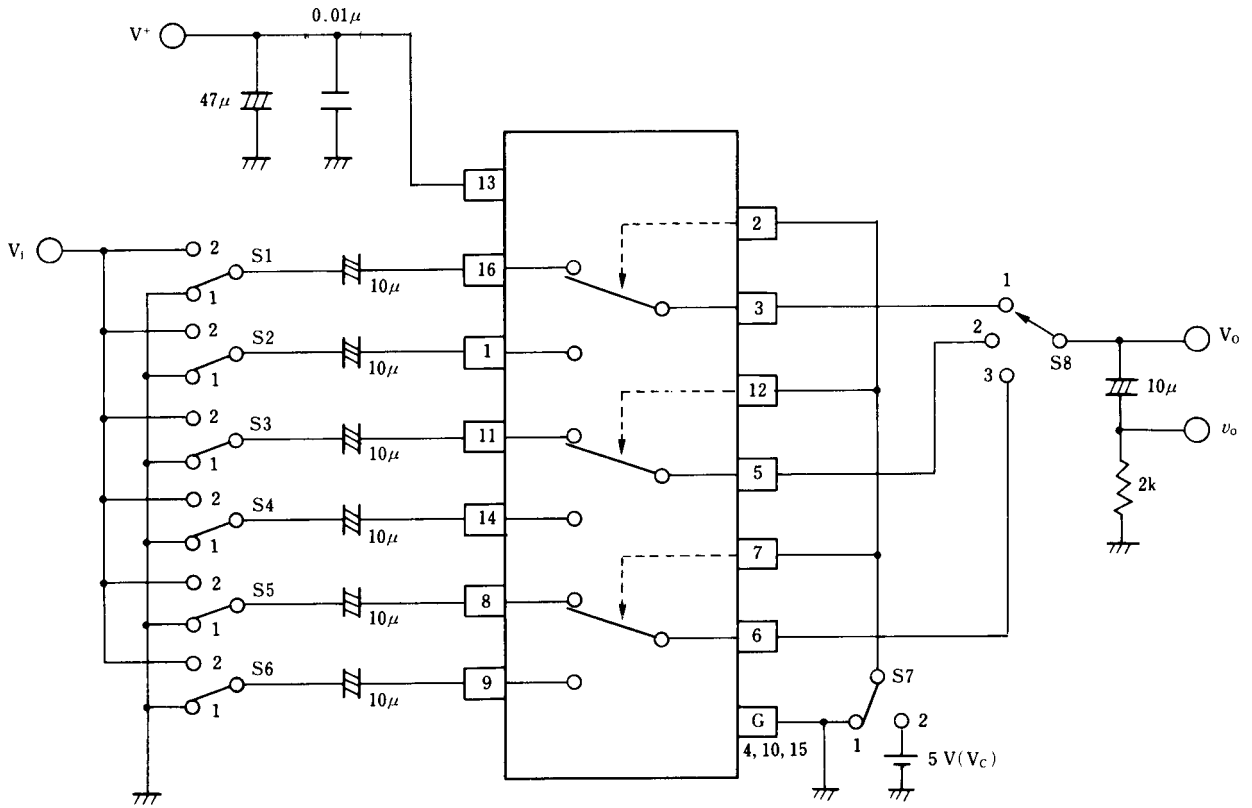

PARAMETER	S1	S2	S3	S4	S5	S6	S7	S8	TEST PART
I_{CC1}	1	1	1	1	1	1	1	1	V^+
I_{CC2}	1	1	1	1	1	1	1	1	V^+
G_{V1}	2	1	1	1	1	1	1	1	V_0
G_{R1}	2	1	1	1	1	1	1	1	V_0
DG_1	2	1	1	1	1	1	1	1	V_0
DP_1	2	1	1	1	1	1	1	1	V_0
CT 1	2	1	1	1	1	1	2	1	V_0
CT 2	1	2	1	1	1	1	1	1	V_0
CT 3	1	1	2	1	1	1	2	2	V_0
CT 4	1	1	1	2	1	1	1	2	V_0
CT 5	1	1	1	1	2	1	2	3	V_0
CT 6	1	1	1	1	1	2	1	3	V_0
V_{OS1}	1	1	1	1	1	1	1/2	1	V_0
V_{C1}	1/2	2/1	1	1	1	1	V_C	1	V_C
THD	2	1	1	1	1	1	1	1	V_0

NJM2286

■ TERMINAL EXPLANATION

PIN No.	PIN NAME	VOLTAGE	INSIDE EQUIVALENT CIRCUIT
16 1 11 14 8 9	IN 1 A IN 1 B IN 2 A IN 2 B IN 3 A IN 3 B [Input]	1.5V	<p>The diagram shows an input terminal labeled 'IN' connected to a 500 ohm resistor. The other end of the resistor is connected to a common ground. A 2.2V source is also connected to the common ground.</p>
2 12 7	CTL 1 CTL 2 CTL 3 [Switching]		<p>The diagram shows a switching circuit. It includes a 2.3V source and a 1.9V source connected to ground. A transistor is driven by the 1.9V source. The collector of this transistor is connected to the base of another transistor. The base of the second transistor is also connected to a common ground through an 8k resistor. The emitter of the second transistor is connected to ground through an 8k resistor. The collector of the second transistor is connected to a terminal labeled 'CTL' through a 20k resistor.</p>
3 5 6	OUT1 OUT2 OUT3 [Output]	0.8V	<p>The diagram shows a simple output stage. A transistor's emitter is connected to ground through a resistor. The collector is connected to a common ground. The base is connected to an input signal. The output terminal 'OUT' is connected to the emitter of the transistor.</p>
13	V ⁺	5V	
15 4 10	GND 1 GND 2 GND 3		

■ TYPICAL CHARACTERISTICS

Operating Current 1 vs. Temperature

($V^+ = 9V$)

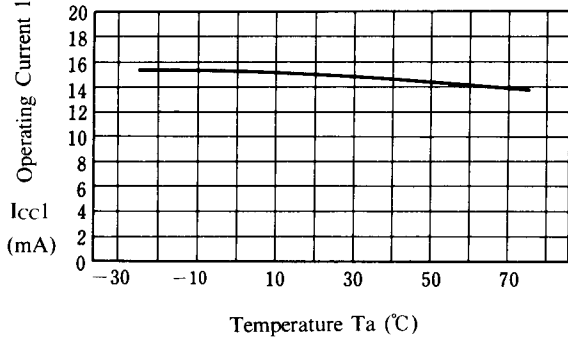

Operating Current vs. Operating Voltage

($T_a = 25^\circ C$)

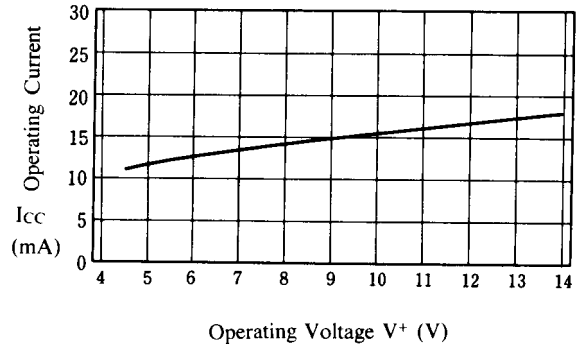

Voltage Gain 1 vs. Temperature

($V^+ = 5V$)

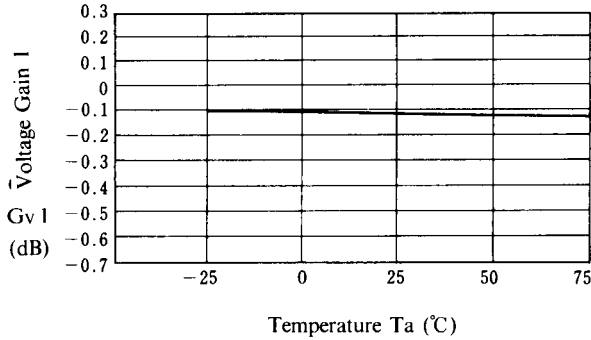

Frequency Gain 1 vs. Temperature

($V^+ = 5V$)

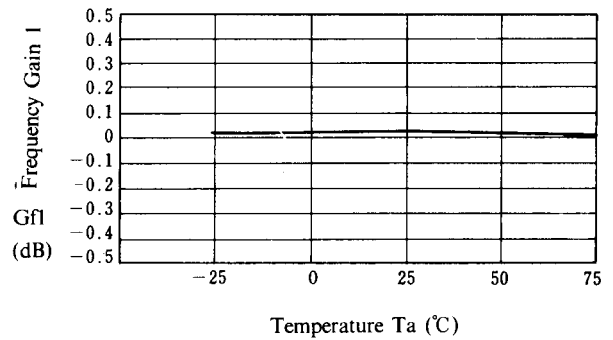

Differential Gain 1 vs. Temperature

($V^+ = 5V$)

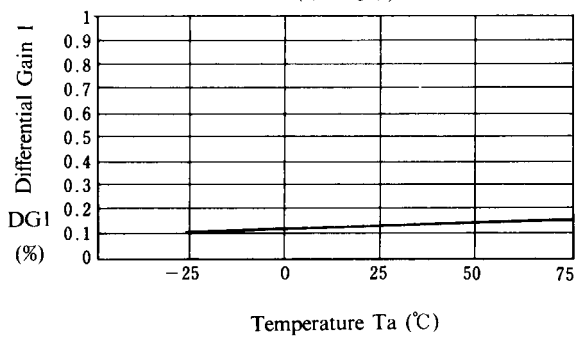

Differential Phase 1 vs. Temperature

($V^+ = 5V$)

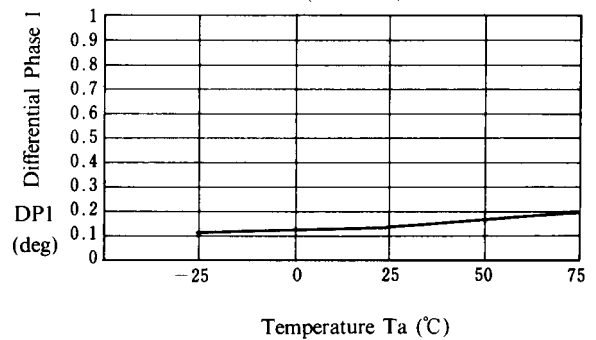

■ TYPICAL CHARACTERISTICS

Offset Voltage vs. Temperature

(V⁺ = 5 V)

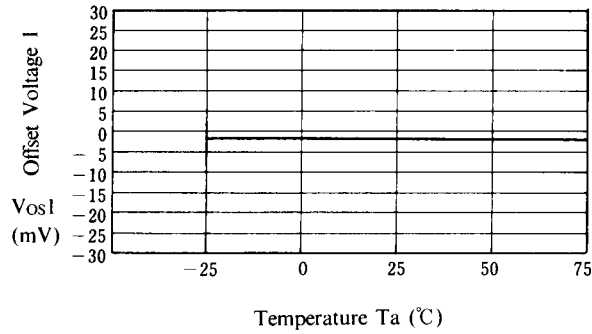

Crosstalk 1 vs. Temperature

(V⁺ = 5 V)

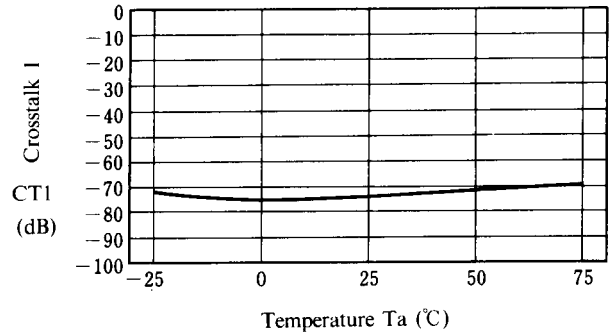

Crosstalk 2 vs. Temperature

(V⁺ = 5 V)

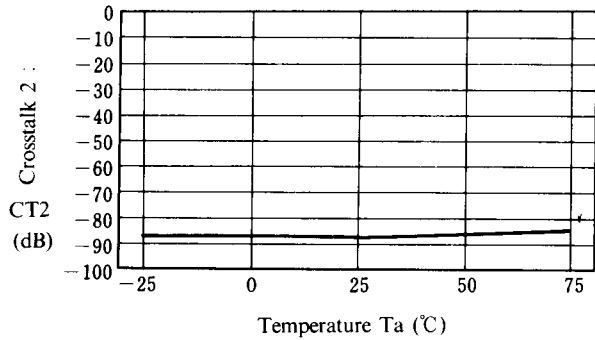

Crosstalk 3 vs. Temperature

(V⁺ = 5 V)

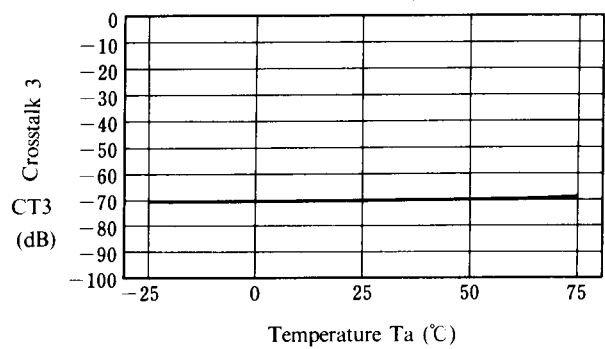

Crosstalk 4 vs. Temperature

(V⁺ = 5 V)

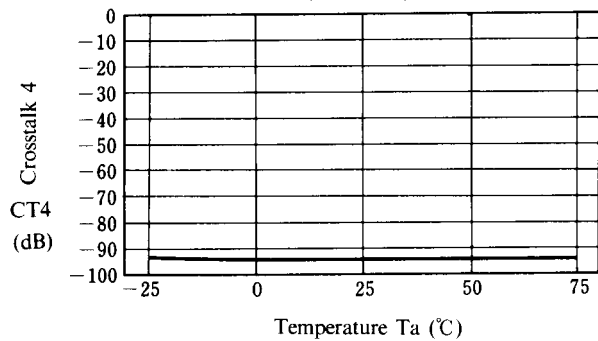

Crosstalk 5 vs. Temperature

(V⁺ = 5 V)

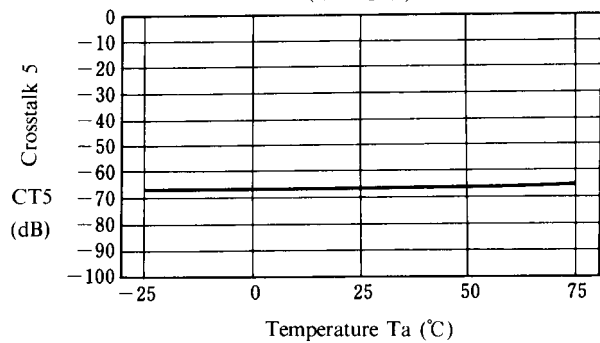

■ TYPICAL CHARACTERISTICS

Crosstalk 6 vs. Temperature
($V^+ = 5\text{ V}$)

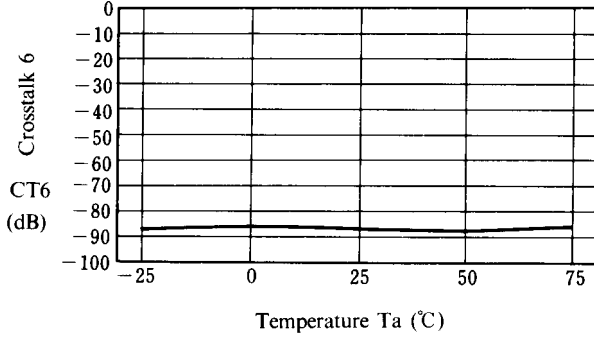

Switch Change Over 1 vs. Temperature
($V^+ = 5\text{ V}$)

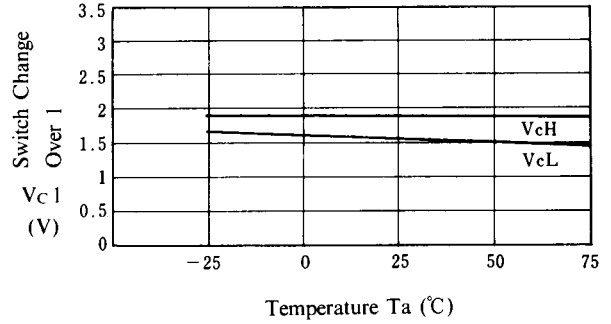

Supply Current 2 vs. Temperature
($V^+ = 5\text{ V}$)

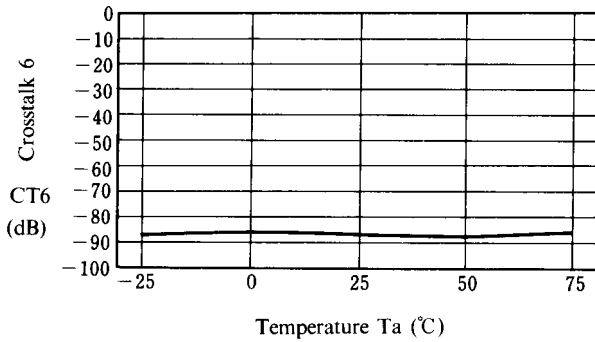

Voltage Gain 1 vs. Operating Voltage
($T_a = 25^\circ\text{C}$)

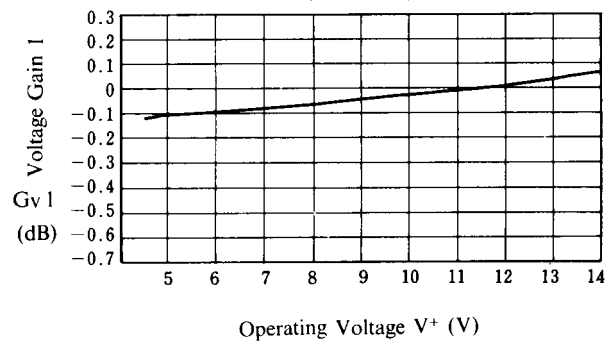

Frequency Gain 1 vs. Operating Voltage
($T_a = 25^\circ\text{C}$)

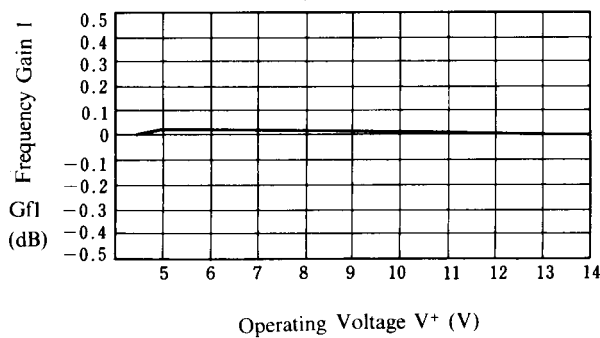

Differential Gain 1 vs. Operating Voltage
($T_a = 25^\circ\text{C}$)

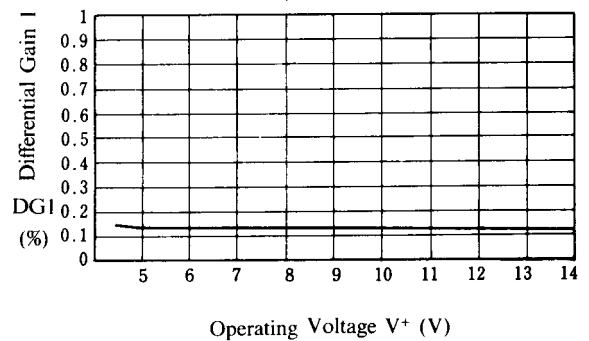

■ TYPICAL CHARACTERISTICS

Differential Phase 1 vs. Operating Voltage

(Ta = 25°C)

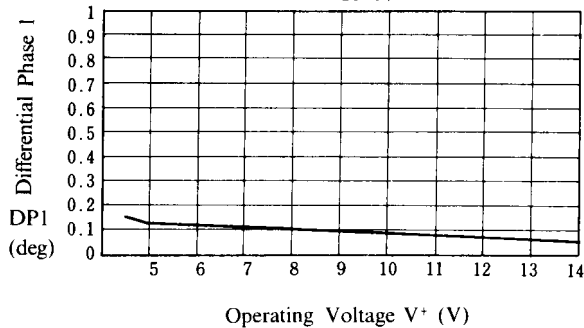

Offset Voltage 1 vs. Operating Voltage

(Ta = 25°C)

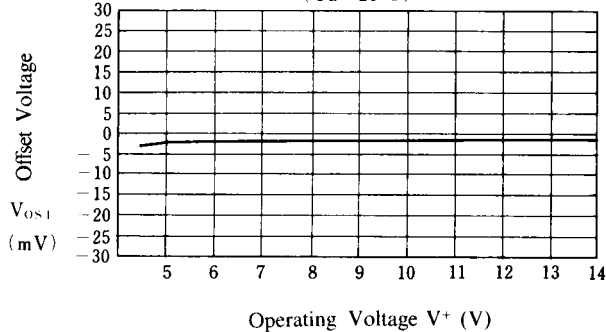

Crosstalk 1 vs. Operating Voltage

(Ta = 25°C)

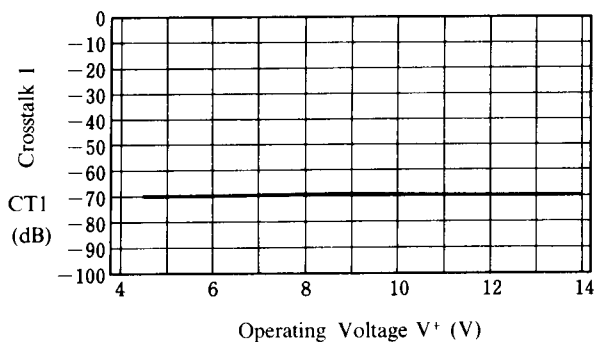

Crosstalk 2 vs. Operating Voltage

(Ta = 25°C)

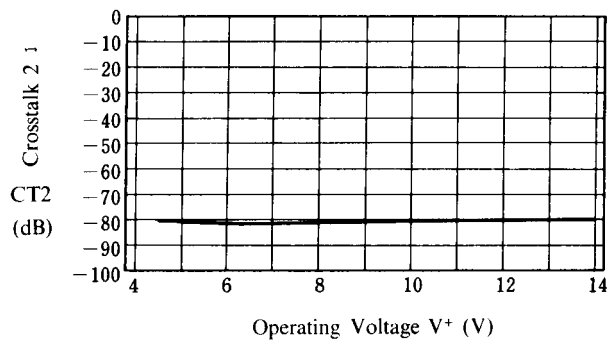

Crosstalk 3 vs. Operating Voltage

(Ta = 25°C)

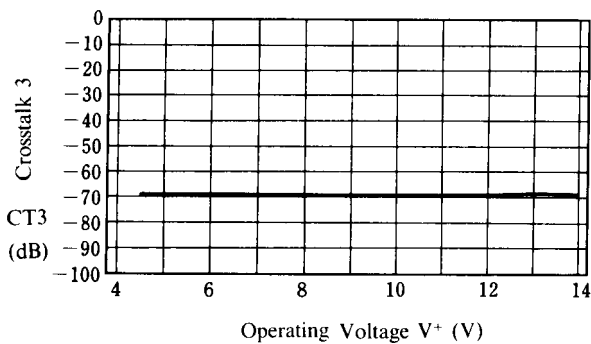

Crosstalk 4 vs. Operating Voltage

(Ta = 25°C)

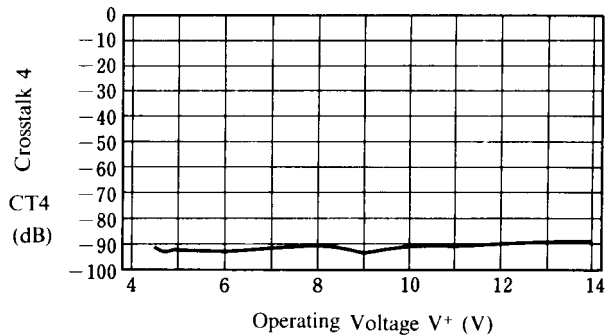

■ TYPICAL CHARACTERISTICS

Crosstalk 5 vs. Operating Voltage
($T_a = 25^\circ\text{C}$)

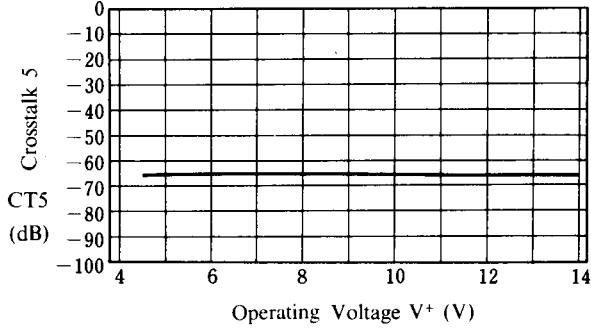

Crosstalk 6 vs. Operating Voltage
($T_a = 25^\circ\text{C}$)

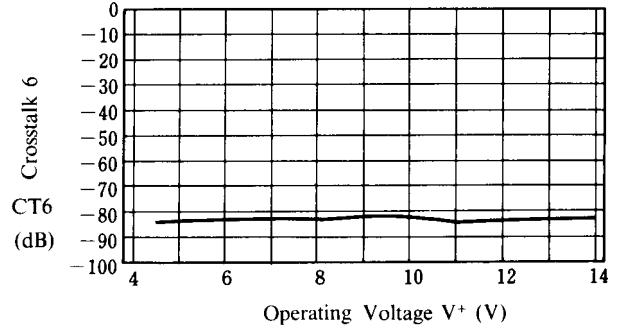

Switch Change Over 1 vs. Operating Voltage
($T_a = 25^\circ\text{C}$)

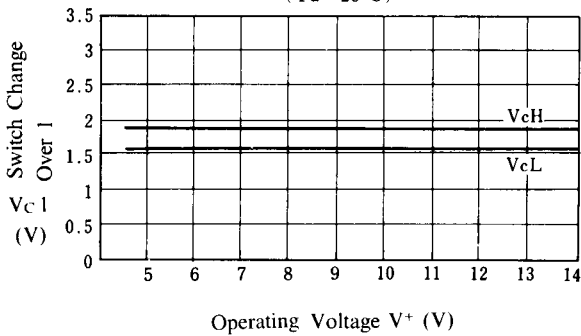

Voltage Gain 1 vs. Frequency Feature
($T_a = 25^\circ\text{C}$)

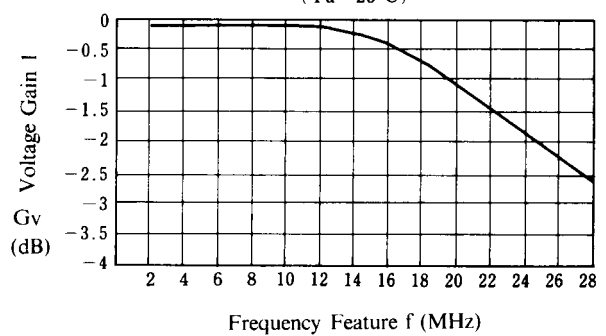

Differential Gain 3 vs. Load Resistor
($T_a = 25^\circ\text{C}$)

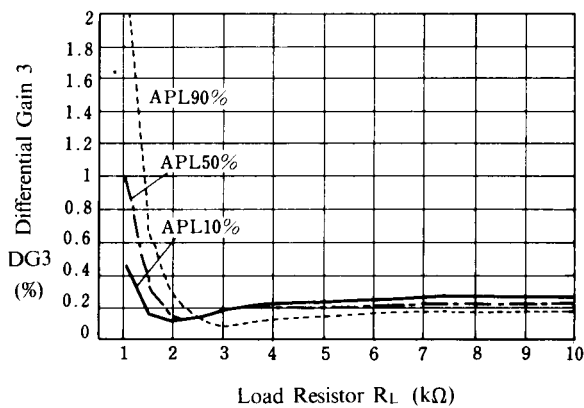

Differential Phase 3 vs. Load Resistor
($T_a = 25^\circ\text{C}$)

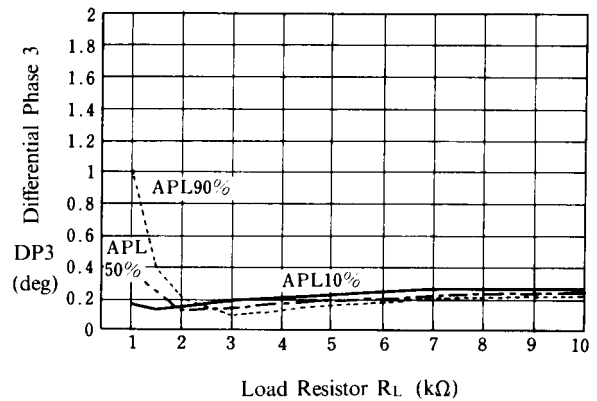

■ TYPICAL CHARACTERISTICS

Differential Gain 3 vs. APL
($T_a = 25^\circ\text{C}$)

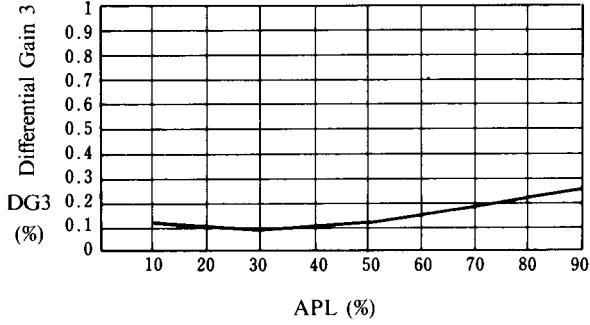

Differential Phase 3 vs. APL
($T_a = 25^\circ\text{C}$)

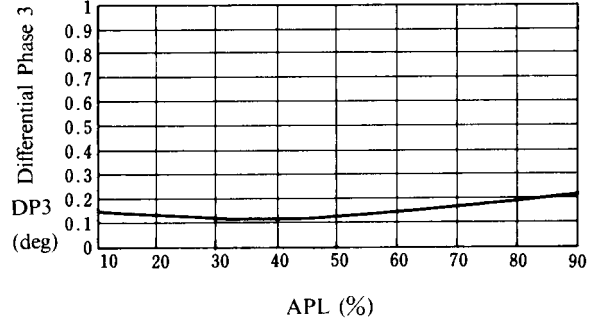

■ APPLICATION

This IC requires $1M\Omega$ resistance between INPUT and GND pin for clamp type input since the minute current causes an unstable pin voltage.

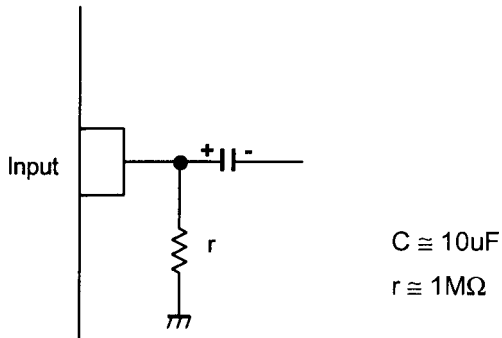

This IC requires $0.1\mu F$ capacitor between INPUT and GND, $1M\Omega$ resistance between INPUT and GND for clamp type input at mute mode.

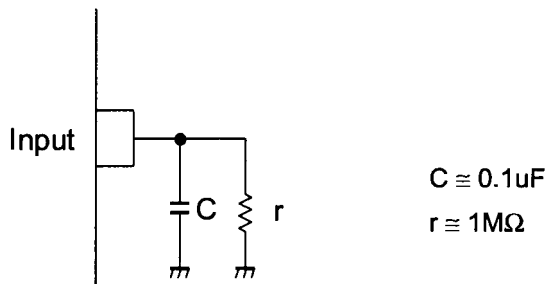

[CAUTION]

The specifications on this databook are only given for information, without any guarantee as regards either mistakes or omissions. The application circuits in this databook are described only to show representative usages of the product and not intended for the guarantee or permission of any right including the industrial rights.