

Designated client product

This product will be discontinued its production in the near term.
And it is provided for customers currently in use only, with a time limit.
It can not be available for your new project. Please select other new or existing products.

For more information, please contact our sales office in your region.

New Japan Radio Co.,Ltd.

www.njr.com

DUAL VIDEO 6dB AMPLIFIER WITH 75Ω DRIVER

■ GENERAL DESCRIPTION

NJM2268 is a dual video 6dB amplifier with 75Ω drivers for S-VHS VCRs, HI-BAND VCRs, etc..One channel has clamp function that fixes DC level of video signal and another one is bias type. Furthermore it has 75Ω drivers to be connected to TV monitors directly and sag corrective circuits that prevent the generation of sag with smaller capacitance than ever.

Its operating supply voltage is 4.85 to 9V and bandwidth is 7MHz.

■ FEATURES

- Wide Operating Voltage (4.85 to 9.0V)
- Dual Channel (Clamp Type, Bias Type)
- Internal Driver Circuit For 75Ω Load
- SAG Corrective Function
- Wide Frequency Range 7MHz
- Low Operating Current 14.0mA (Dual)
- Package Outline DIP8, DMP8, SSOP8
- Bipolar Technology

■ RECOMMENDED OPERATING CONDITION

- Operating Voltage V^+ 4.85 to 9.0V

■ APPLICATIONS

- VCR, Video Camera, TV, Video Disc Player

■ BLOCK DIAGRAM

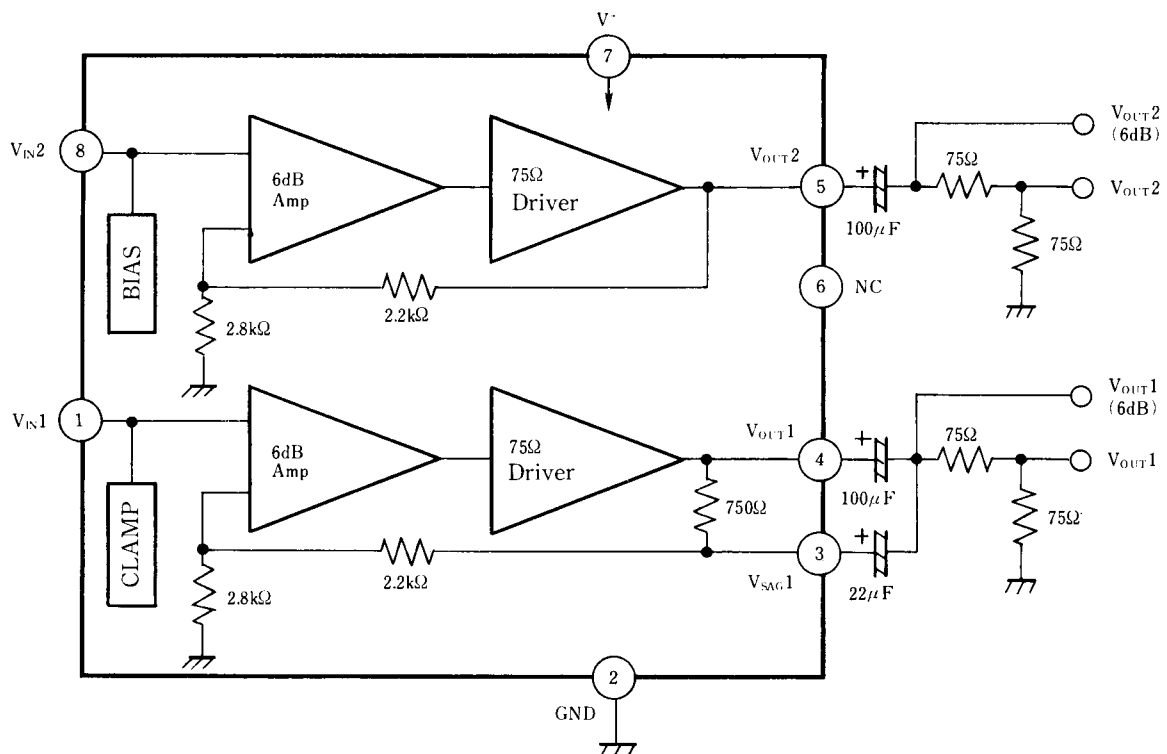

■ PACKAGE OUTLINE

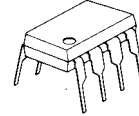

NJM2268D



NJM2268M



NJM2268V

NJM2268

■ ABSOLUTE MAXIMUM RATINGS

(Ta=25°C)

| PARAMETER | SYMBOL | RATINGS | UNIT |
|-----------------------------|------------------|-----------------------------------------|----------------|
| Supply Voltage | V ⁺ | 10 | V |
| Power Dissipation | P _D | (DIP8) 500 (DMP8) 300 (SSOP8) 250 | mW mW mW |
| Operating Temperature Range | T _{opr} | -40 to +85 | °C |
| Storage Temperature Range | T _{stg} | -40 to +125 | °C |

■ ELECTRICAL CHARACTERISTICS

(V⁺=5V, Ta=25°C)

| PARAMETER | SYMBOL | TEST CONDITION | MIN. | TYP. | MAX. | UNIT |
|--------------------------|------------------|--------------------------------------------------------------------------------------------------|------|------|------|------|
| Operating Current | I _{CC} | No Signal | - | 14.0 | 18.2 | mA |
| Voltage Gain | G _V | V _{IN} =1MHz, 1V _{P-P} Sinewave | 5.7 | 6.2 | 6.7 | dB |
| Frequency Characteristic | G _f | V _{IN} =1V _{P-P} , Sinewave, 7MHz / 1MHz | - | - | ±1.0 | dB |
| Differential Gain* | DG | V _{IN} =1V _{P-P} , Staircase | - | 1.0 | 3.0 | % |
| Differential Phase* | DP | V _{IN} =1V _{P-P} , Staircase | - | 1.0 | 3.0 | deg |
| Crosstalk | CT | V _{IN} =4.43MHz, 1V _{P-P} , Sinewave | - | -70 | - | dB |
| Gain Offset | G _{CH} | V _{IN} =1MHz, 1V _{P-P} , G _{CH} =V _{OUT1} -V _{OUT2} | - | - | ±0.5 | dB |
| Input Clamp Voltage | V _{CL} | | 1.79 | 1.91 | 2.03 | V |
| Input Bias Voltage | V _{BI} | | 2.56 | 2.84 | 3.12 | V |
| SAG Terminal Gain | G _{SAG} | | 35 | 45 | - | dB |

NOTE: "*" is applied to clamp type input side only /

■ APPLICATION

Oscillation Prevention

It is much effective to insert LPF (Cutoff Frequency 70MHz) under light loading conditions (R_L » 1kΩ).

This IC requires 1MΩ resistance between INPUT and GND pin for clamp type input since the minute current causes an unstable pin voltage.

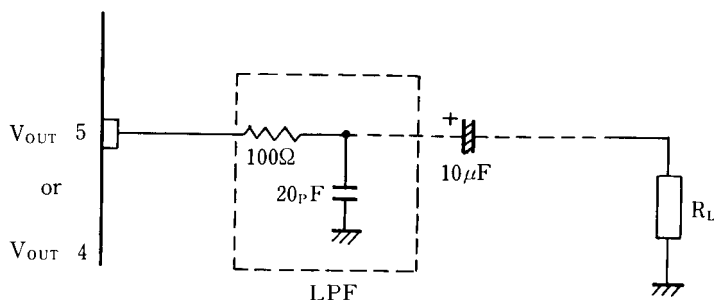

■ TEST CIRCUIT

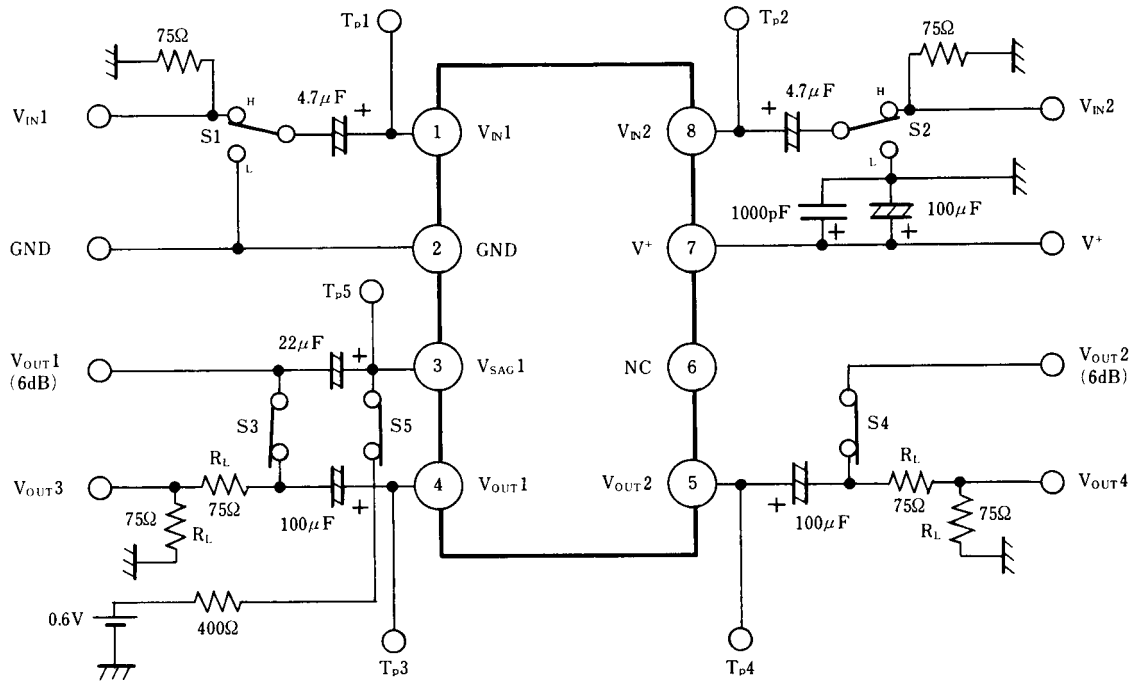

■ TEST METHODES

| PARAMETER | SYMBOL | SWITCH CONDITIONS | | | | | | CONDITIONS |
|--------------------------|-----------|-------------------|----|----|----|----|----|----------------------------------------------------------------------------------------------------------------------------------------------------------------------------------------------------|
| | | S1 | S2 | S3 | S4 | S5 | S6 | |
| Supply Current | I_{CC} | H | H | | | | | 7PIN Sink Current |
| Voltage Gain | G_V | H | H | ON | ON | | | V_{OUT1} / V_{IN1} , V_{OUT2} / V_{IN2} at $V_{IN1}(V_{IN2})=1\text{MHz}$, $1V_{P-P}$, Sinewave |
| Frequency Characteristic | G_f | H | H | ON | ON | | | G_{V1M} ; Voltage Gain at V_{IN1} (V_{IN2})= 1MHz , $1V_{P-P}$ G_{V10M} ; Voltage Gain at V_{IN1} (V_{IN2})= 10MHz , $1V_{P-P}$ $G_f = G_{V10M} - G_{V1M}$ |
| Differential Gain | DG | H | H | ON | ON | | | Measuring V_{OUT3} at V_{IN1} =Staircase Signal |
| Differential Phase | DP | H | H | ON | ON | | | Measuring V_{OUT3} at V_{IN1} =Staircase Signal |
| Crosstalk | CT | H | L | ON | ON | | | V_{OUT2} / V_{OUT1} at $V_{IN1}=4.43\text{MHz}$, $1V_{P-P}$, Sinewave V_{OUT1} / V_{IN2} at $V_{IN2}=4.43\text{MHz}$, $1V_{P-P}$, Sinewave |
| Gain Offset | G_{CH} | H | H | ON | ON | | | $G_{V1} = V_{OUT1} / V_{IN1}$, $G_{V2} = V_{OUT2} / V_{IN2}$ $G_{CH} = G_{V1} - G_{V2}$ |
| Input Clamp Voltage | V_{CL} | H | H | | | | | Measuring at TP1 |
| Input Bias Voltage | V_{Bt} | H | H | | | | | Measuring at TP2 |
| SAG Terminal Gain | G_{SAG} | H | H | | | ON | ON | TP3 Voltage; V_{O1A} , TP5 Voltage; V_{SO1A} TP3 Voltage; V_{O1B} , TP5 Voltage; V_{SO1B} $G_{SAG} = 20 \log \{ (V_{O1B} - V_{O1A}) / (V_{SO1A} - V_{SO1B}) \}$ |

NJM2268

■ TERMINAL FUNCTION

($V^+ = 5.0V$, $T_a = 25^\circ C$)

| PIN No. | PIN NAME | SYMBOL | EQUIVALENT CIRCUIT | FUNCTIONS |
|---------|----------------------|------------|--------------------|--------------------------------------------------------------------------------------------------------------------------------------------------------------------------------------------------------------------------------------------------------------------------------|
| 1 | Input Clamp Terminal | V_{IN1} | | Input terminal of $1V_{P-P}$ composite Signal or Y signal. Clamp level is 1.9V |
| 2 | GND | GND | | Ground |
| 3 | SAG correction | V_{SAG1} | | SAG caused by a coupling capacitor of the output can be prevented by connecting this terminal with the output terminal through an external capacitor.(see block diagram) When SAG correcting function is not necessary, this terminal must be connected with pin "4" directly. |
| 4 | Video Output1 | V_{OUT1} | | Output terminal (clamp side) that can drive 75Ω line. |
| 5 | Video Output2 | V_{OUT2} | | Output terminal (bias side) that can drive 75Ω line. |
| 6 | No Connection | NC | | |
| 7 | V^+ | V^+ | | Supply Voltage |
| 8 | Input Clamp Terminal | V_{IN2} | | Input terminal of $1V_{P-P}$ coler signal. Bias level is 2.8V. |

■ TYPICAL CHARACTERISTICS

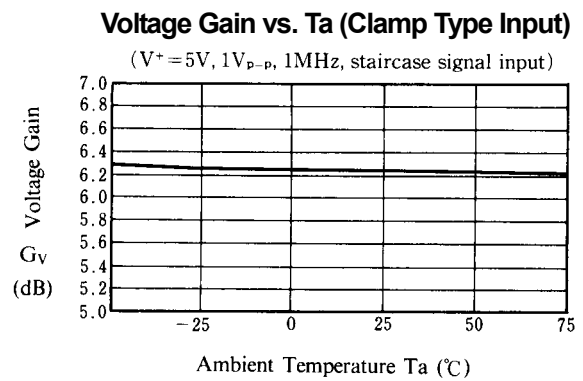
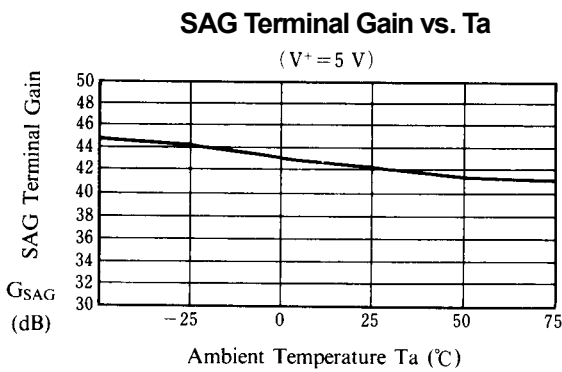
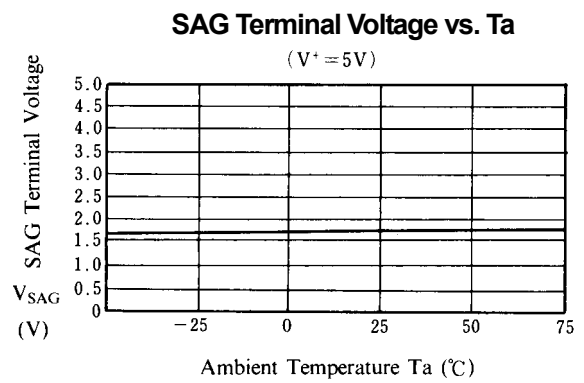
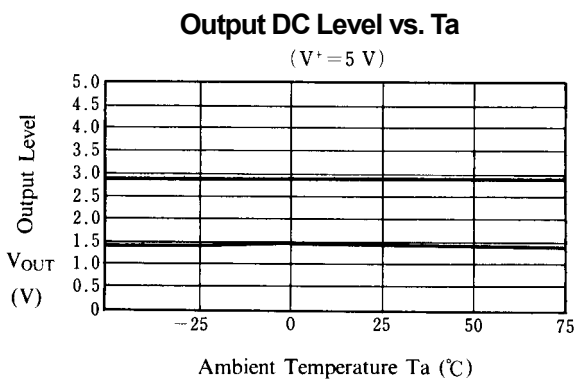
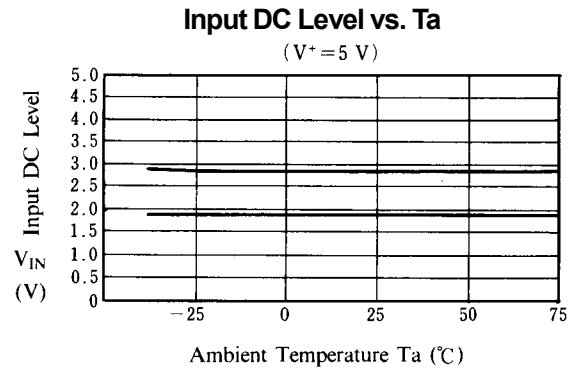
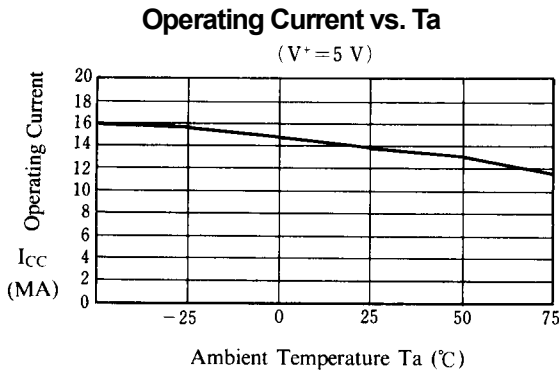

■ TYPICAL CHARACTERISTICS

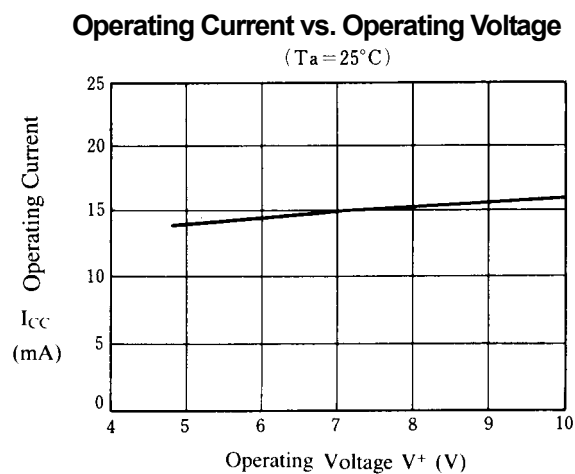
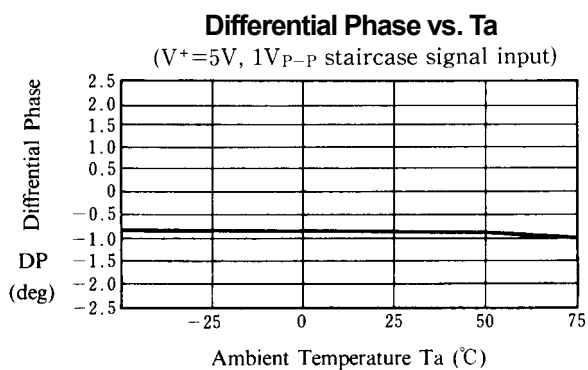
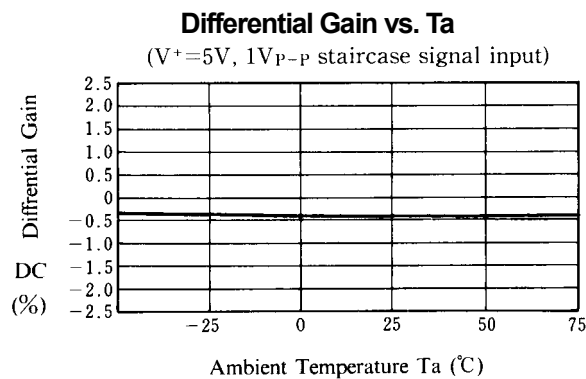
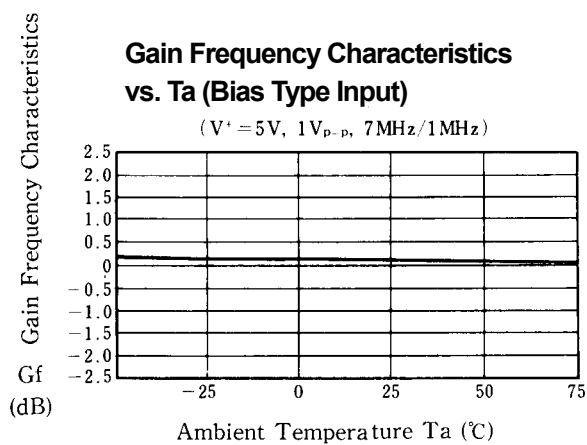
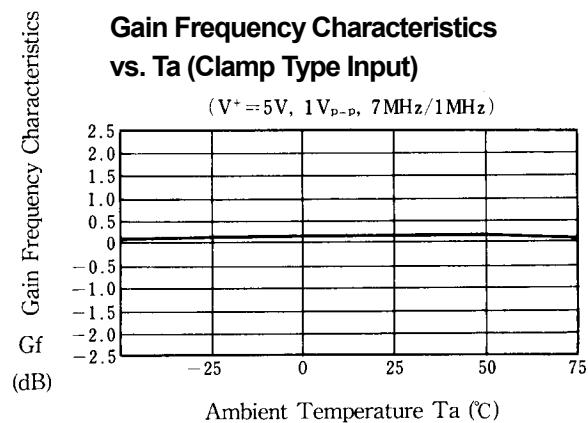
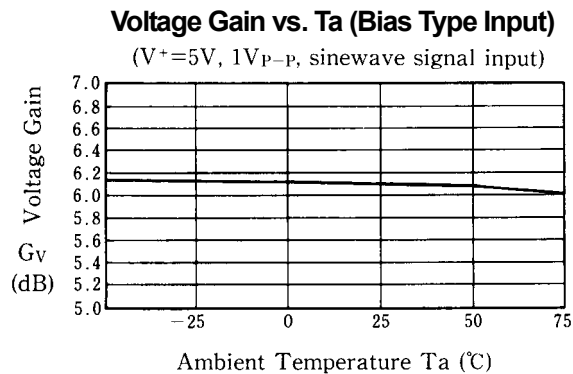

■ TYPICAL CHARACTERISTICS

Input DC Level vs. Operating Voltage

($T_a = 25^\circ\text{C}$)

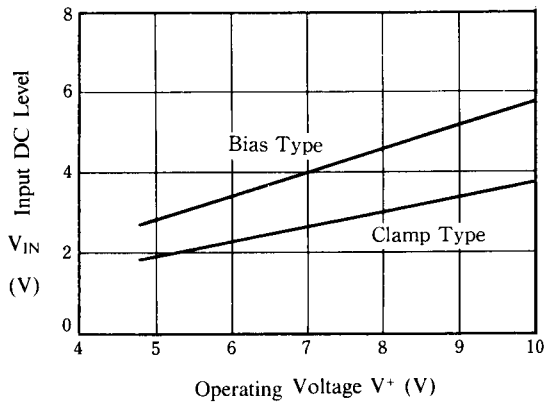

Output DC Level vs. Operating Voltage

($T_a = 25^\circ\text{C}$)

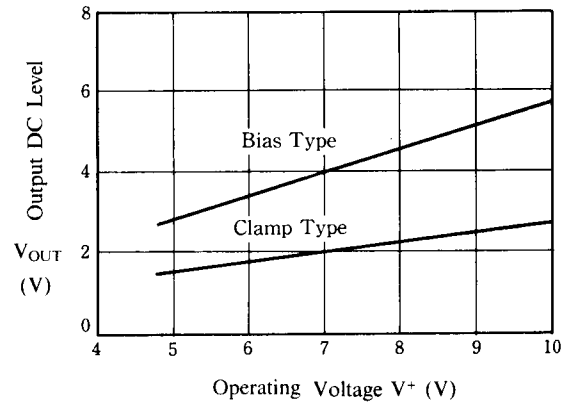

SAG Terminal Voltage vs. Operating Voltage

($T_a = 25^\circ\text{C}$)

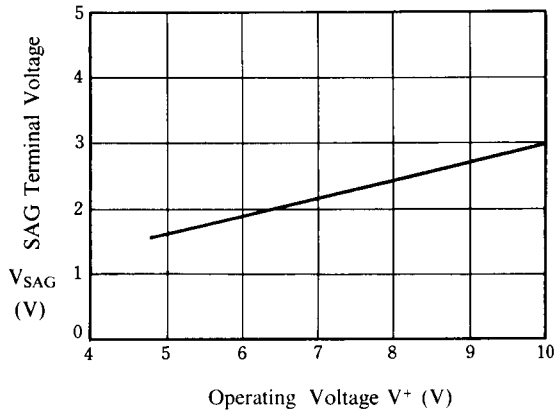

SAG Terminal Gain vs. Operating Voltage

($T_a = 25^\circ\text{C}$)

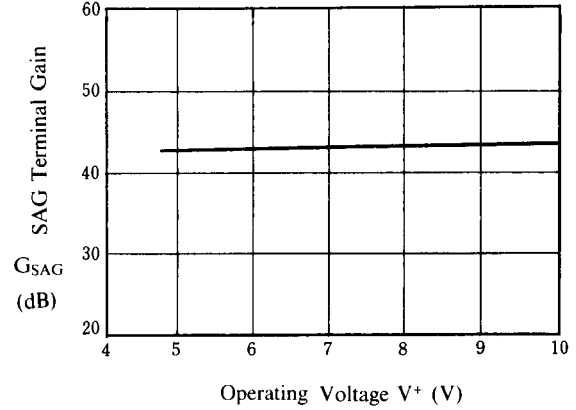

**Voltage Gain vs. Operating Voltage
(Clamp Type Input)**

($T_a = 25^\circ\text{C}$, $1V_{P-P}$, 1MHz sinewave signal input)

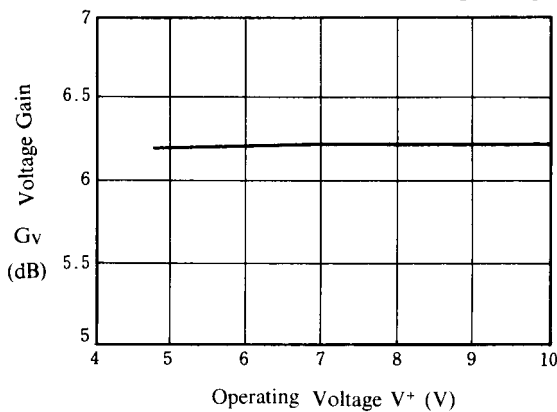

**Voltage Gain vs. Operating Voltage
(Bias Type Input)**

($T_a = 25^\circ\text{C}$, $1V_{P-P}$, 1MHz sinewave signal input)

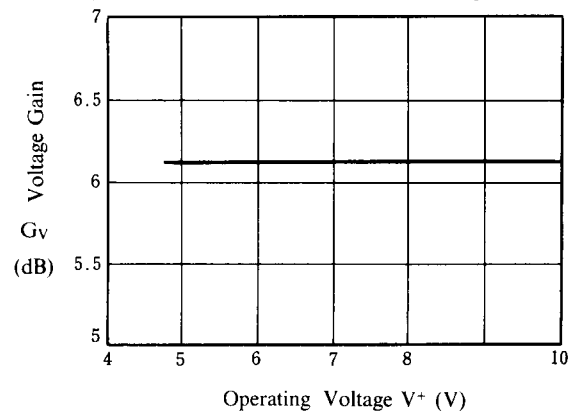

■ TYPICAL CHARACTERISTICS

Gain Frequency Characteristics vs. Operating Voltage (Clamp Type Input)
 (Ta=25°C, 1V_{p-p}, 7MHz/1MHz)

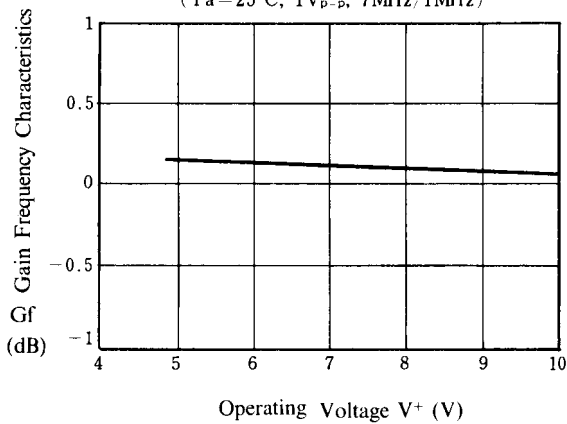

Gain Frequency Characteristics vs. Operating Voltage (Bias Type Input)
 (Ta=25°C, 1V_{p-p}, 7MHz/1MHz)

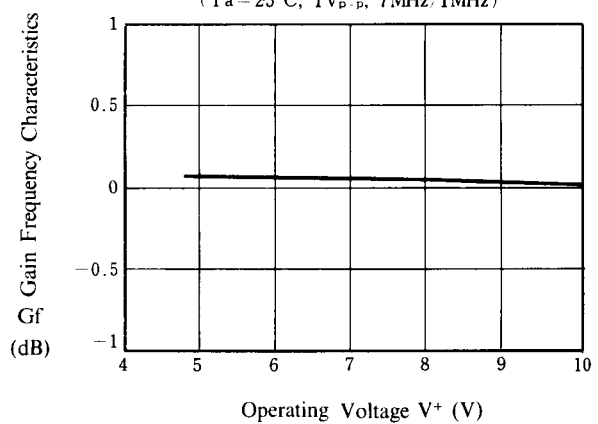

Differential Gain vs. Operating Voltage
 (Ta=25°C, 1V_{p-p}, staircase signal input)

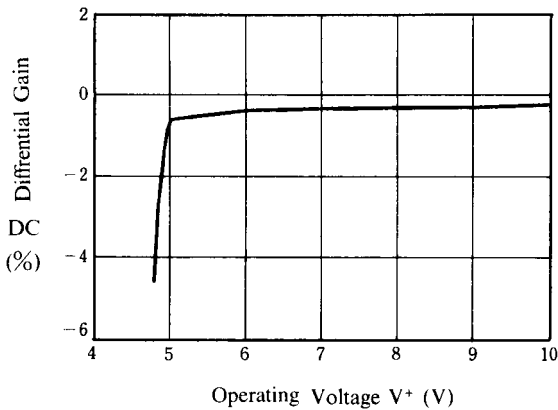

Differential Phase vs. Operating Voltage
 (Ta=25°C, 1V_{p-p}, staircase signal input)

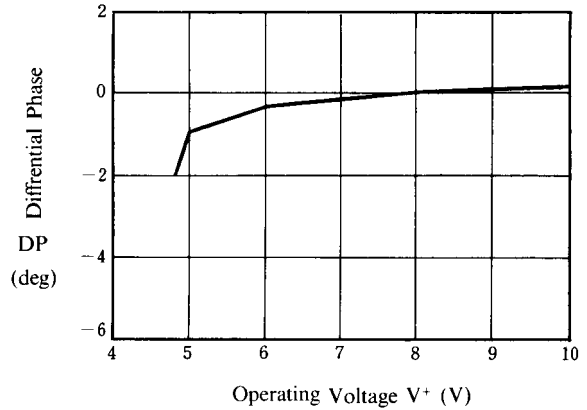

Voltage Gain vs. Frequency (Clamp Type Input)
 (Ta=25°C, V+=5V, 1V_{p-p} sinewave signal input)

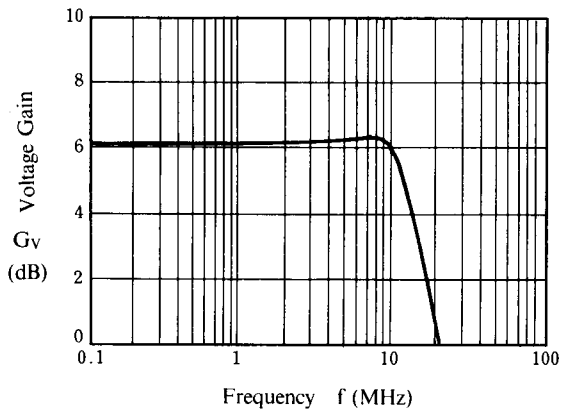

Voltage Gain vs. Frequency (Bias Type Input)
 (Ta=25°C, V+=5V, 1V_{p-p} sinewave signal input)

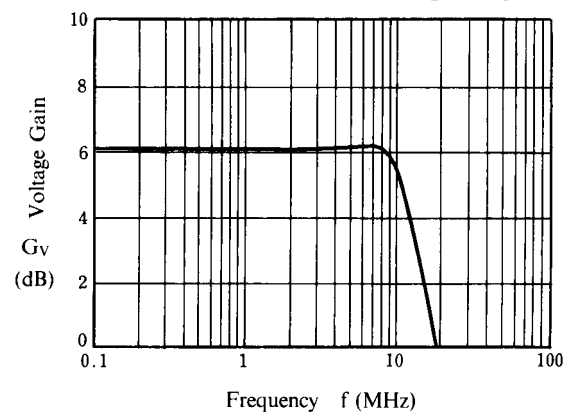

■ TYPICAL CHARACTERISTICS

Small Signal Voltage Gain vs. Frequency (Clamp Type Input)

($T_a=25^\circ\text{C}$, $V^+=5V_{P-P}$, $25mV_{P-P}$ sinewave signal input)

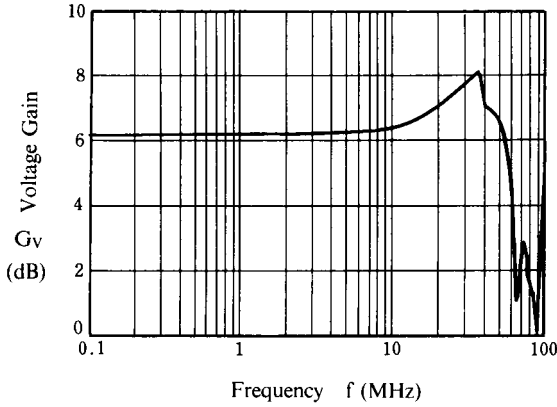

Small Signal Voltage Gain vs. Frequency (Bias Type Input)

($T_a=25^\circ\text{C}$, $V^+=5V$, $25mV_{P-P}$ sinewave signal input)

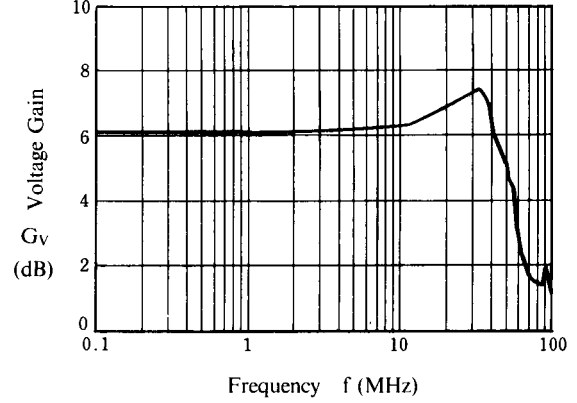

Cross Talk vs. Frequency

($T_a=25^\circ\text{C}$, $V^+=5V$, $1V_{P-P}$ sinewave signal input)

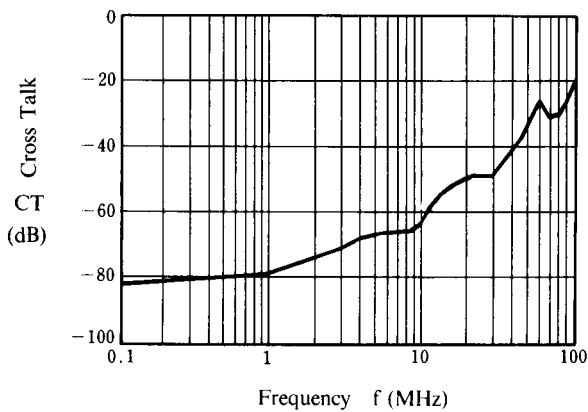

Voltage Gain vs. R_L (Clamp Type Input)

($T_a=25^\circ\text{C}$, $V^+=5V$, $1V_{P-P}$, 1MHz, sinewave signal input)

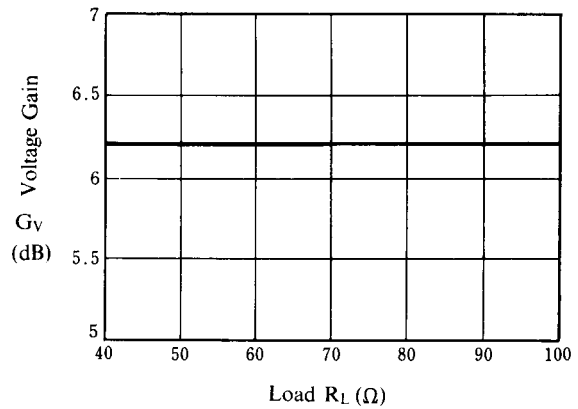

Voltage Gain vs. R_L (Bias Type Input)

($T_a=25^\circ\text{C}$, $V^+=5V$, $1V_{P-P}$, 1MHz sinewave signal input)

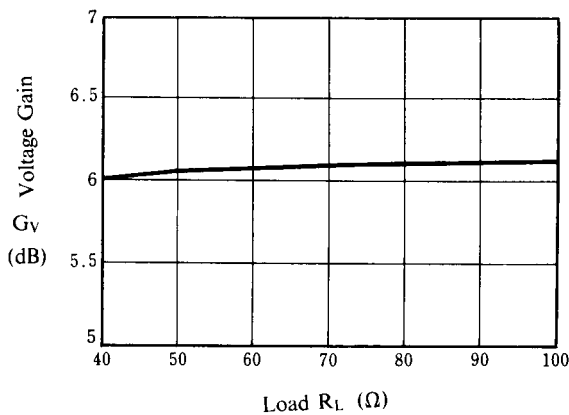

Gain Frequency Characteristics vs. R_L (Clamp Type Input)

($T_a=25^\circ\text{C}$, $V^+=5V$, $1V_{P-P}$, 7MHz/1MHz)

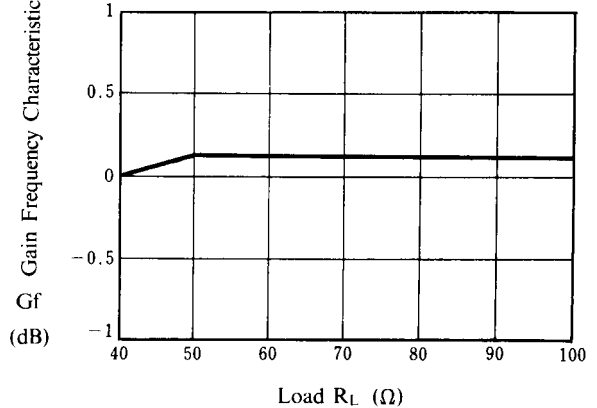

■ TYPICAL CHARACTERISTICS

Gain Frequency Characteristics vs. R_L (Bias Type Input)

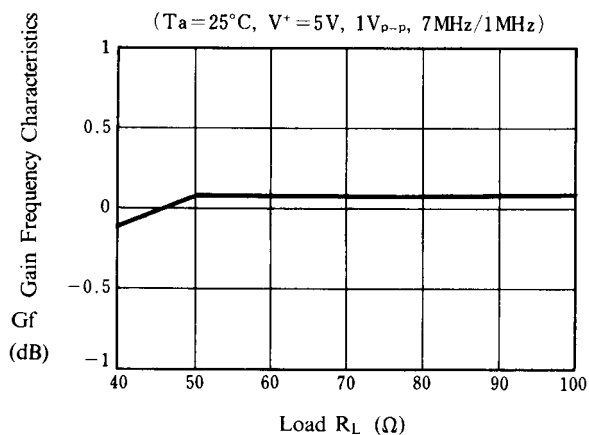

Differential Gain vs. R_L

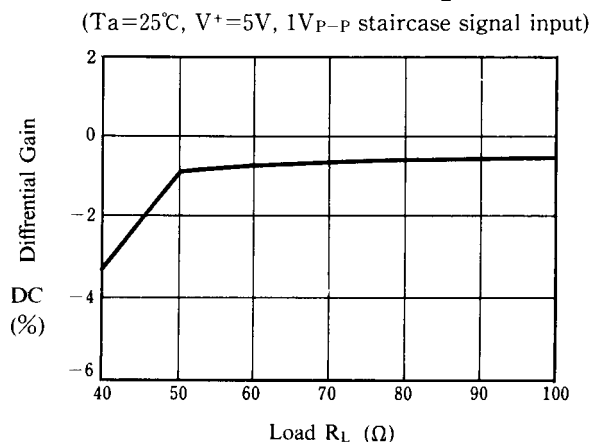

Differential Phase vs. R_L

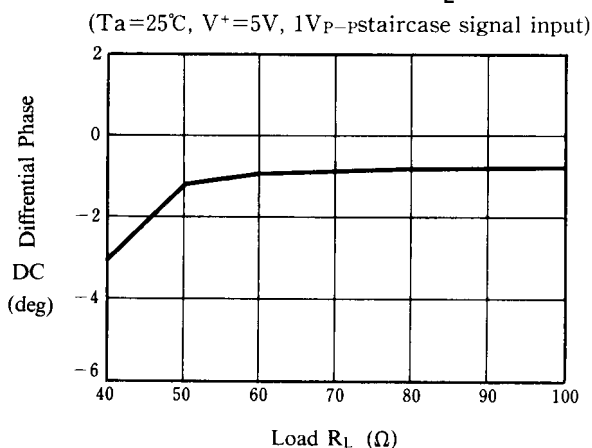

Differential Gain vs. APL

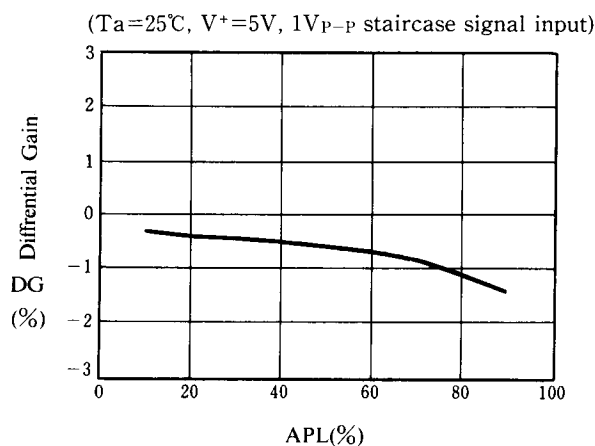

Differential Phase vs. APL

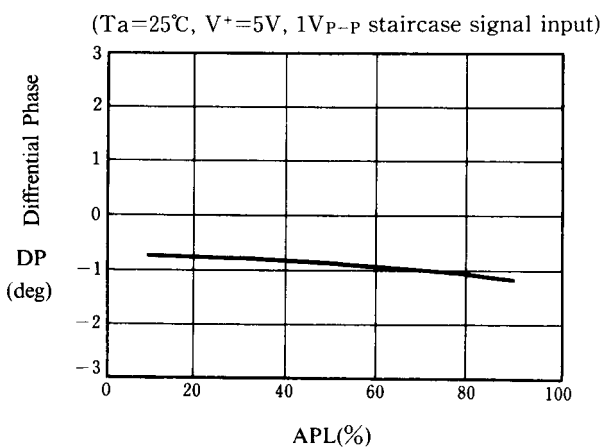

■ APPLICATION

This IC requires $1M\Omega$ resistance between INPUT and GND pin for clamp type input since the minute current causes an unstable pin voltage.

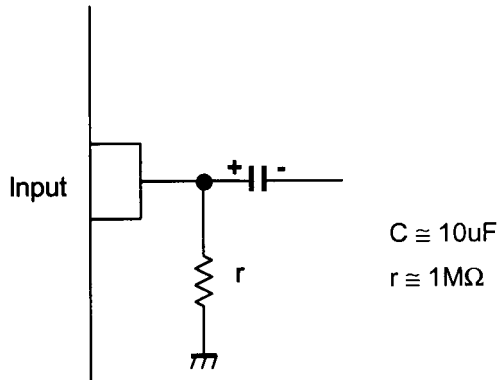

[CAUTION]

The specifications on this databook are only given for information, without any guarantee as regards either mistakes or omissions. The application circuits in this databook are described only to show representative usages of the product and not intended for the guarantee or permission of any right including the industrial rights.