

# PLL Synthesizer with I<sup>2</sup>C Bus for TV

## ■ GENERAL DESCRIPTION

The **NJW1504** is a PLL frequency synthesizer especially designed for TV and VCR tuning systems and consists of PLL circuit and a prescaler which operates up to 1.0GHz, built into one chip. The NJW1504 is controlled through an I<sup>2</sup>C-bus.

## ■ PACKAGE OUTLINE

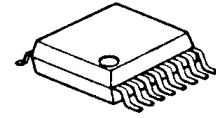

**NJW1504V**

## ■ FEATURES

- Operating Voltage                    5V
- Low Operating Current                15mA typ. @Vcc=5V
- Prescaler accepts frequencies up to 1GHz on chip
- Reference Signal Oscillator with peripheral of Xtal on chip
- 34V max. tuning voltage output
- Package Outline                        SSOP16

## ■ BLOCK DIAGRAM

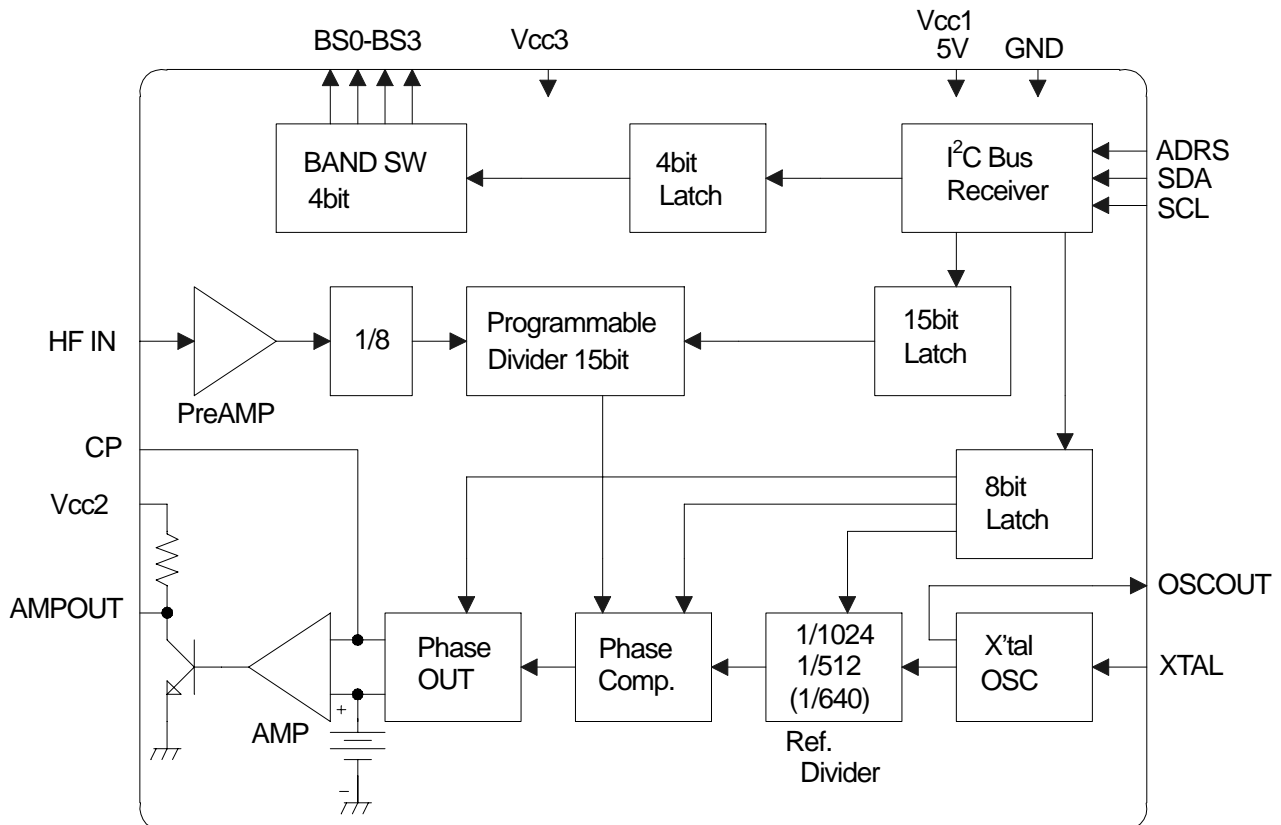

(Note)

Purchase of I<sup>2</sup>C components of New Japan Radio Co.,Ltd or one of its sublicensed Associated Companies conveys a license under the Philips I<sup>2</sup>C Patent Rights to use these components in an I<sup>2</sup>C system, provided that the system conforms to the I<sup>2</sup>C standard specification as defined by Philips.

## ■ ABSOLUTE MAXIMUM RATINGS (T<sub>A</sub>=25°C)

Parameter	Symbol	Ratings	Unit
Supply Voltage (Vcc1, 3)	Vcc1, Vcc3	-0.3 to +6.5	V
Supply Voltage (Vcc2)	Vcc2	-0.3 to +36.0	V
Input Voltage (except I <sup>2</sup> C bus)	V <sub>i</sub>	-0.3 to Vcc + 0.3	V
Output Voltage (except I <sup>2</sup> C bus)	V <sub>o</sub>	-0.3 to Vcc + 0.3	V
I <sup>2</sup> C bus Input Voltage	V <sub>iiic</sub>	-0.3 to +6.5	V
Power Dissipation	P <sub>D</sub>	300	mW
Operating Temperature Range	T <sub>opr</sub>	-20 to +85	°C
Storage Temperature Range	T <sub>stg</sub>	-40 to +125	°C

## ■ RECOMMENDED OPERATING CONDITION (T<sub>A</sub>=25°C)

Parameter	Condition	Symbol	Min.	Typ.	Max.	Unit
Operating Voltage	Vcc1, Vcc3	Vcc1, Vcc3	4.5	5	5.5	V
Operating Voltage	Vcc2	Vcc2	0	-	34	V
X'tal Operating Range		f <sub>xtal</sub>	3.15	4	4.05	MHz
HF Input Frequency	Input= -20dBm	f <sub>HF</sub>	80	-	1000	MHz
Clock Frequency	Refer to I <sup>2</sup> C bus Timing Chart	f <sub>SCL</sub>	0	-	100	kHz
Bus Free Time		t <sub>BUF</sub>	4.7	-	-	us
Data Hold Time		t <sub>HDSTA</sub>	2	-	-	us
SCL Low Hold Time		t <sub>LOW</sub>	4.7	-	-	us
SCL High Hold Time		t <sub>HIGH</sub>	2	-	-	us
Set-up Time		t <sub>SUSTA</sub>	4.7	-	-	us
Data Hold Time		t <sub>HDDAT</sub>	0	-	-	us
Data Set-up Time		t <sub>SUDAT</sub>	250	-	-	ns
Rise Time		t <sub>R</sub>	-	-	1000	ns
Fall Time		t <sub>F</sub>	-	-	300	ns
Data Set-up Time		t <sub>SUSTO</sub>	4.0	-	-	us

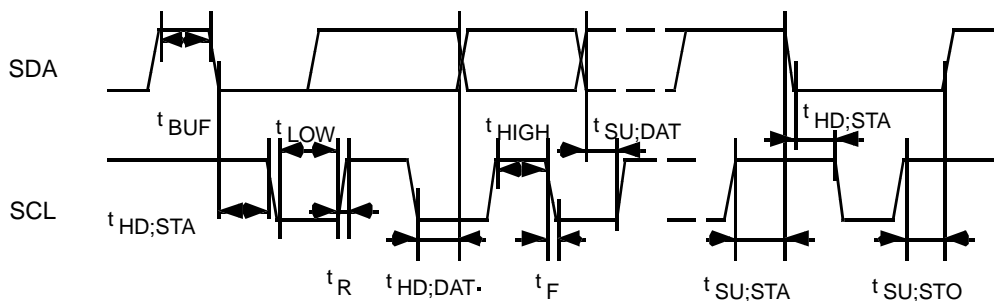

I<sup>2</sup>C bus Timing Chart

V<sub>IHmin</sub> (0.7 Vcc1) and V<sub>ILmax</sub> (0.3 Vcc1)

**■ ELECTRICAL CHARACTERISTICS**

 (V<sub>CC1,3</sub>=5V, V<sub>CC2</sub>=34V, T<sub>A</sub>=25°C)

Parameter	Condition	Symbol	Min.	Typ.	Max.	Unit
Operating Current 1	f <sub>HF</sub> =100MHz	I <sub>CC</sub>	12	15	21	mA
Operating Current 2	AMPOUT: Low Level	I <sub>CC2</sub>	-	1.6	-	mA
AMP Input Current	Phase OUT: High Imp (2.5V)	I <sub>IN</sub>	(-50)	0.1	(50)	nA
AMP Output Current	ANP OUT: Low Level AMPOUT Input=5V	I <sub>OUT</sub>	-	-	-2.0	mA
AMP Gain	f=1KHz	AV	40	50	60	dB
Phase Comparator Output Current	Current Source	I <sub>source</sub>	190	280	400	uA
Phase Comparator Output Current	Current Sink	I <sub>sink</sub>	-400	-280	-190	uA
Band Switch						
"L" Output Current	BS0=BS1=0.3V	I <sub>OBS0-1L</sub>	-2.0	-1.0	0.0	mA
"H" Output Current	BS0=BS1=4.7V	I <sub>OBS0-1H</sub>	11.0	15.0	-	mA
"L" Output Current	BS2=BS3=0.3V	I <sub>OBS2-3L</sub>	-2.0	-1.0	0.0	mA
"H" Output Current	BS2=BS3=4.7V	I <sub>OBS2-3H</sub>	5.5	7.5	-	mA
I <sup>2</sup> C bus						
"H" Input Current	SCL, SDA Terminal	I <sub>INH</sub>	-5	0	5	uA
"L" Input Current		I <sub>INL</sub>	-5	0	5	uA
"H" Input Voltage Range		V <sub>IH</sub>	3.5	-	5.3	V
"L" Input Voltage Range		V <sub>IL</sub>	0	-	1.5	V
ACK Sink Current	ACK Output, SDA=0.4V	V <sub>ACK</sub>	3.0	-	-	mA

## ■ I<sup>2</sup>C bus Protocols

The input information, which consists of chip address and next two or four byte data, is received by I<sup>2</sup>C bus receiver. The allowable I<sup>2</sup>C bus protocols are as follows.

- (1) STA CA CB BB STO
- (2) STA CA D1 D2 STO
- (3) STA CA CB BB D1 D2 STO
- (4) STA CA D1 D2 CB BB STO

STA: Start Condition

STO: Stop Condition

CA: Chip Address

CB: Control Byte

BB: Band switch Byte

D1: Divider Byte 1

D2: Divider Byte 2

For suitable circuit operation, 5-byte data should have chip address, 2-byte control data, band data, and 2-byte divider byte. Following chip address, 2-byte data is received. For distinction of each data, first and third data byte has a function bit. As function bit, divider byte has "1" and control/band data has "0".

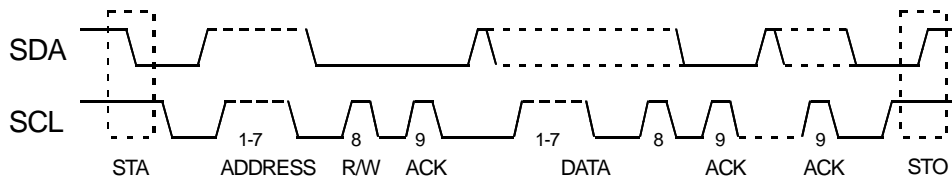

**■ Data Format**

Parameter	Symbol	MSB								LSB
Chip Address	CA	1	1	0	0	0	CA1	CA0	0	A
Divider Byte 1	D1	0	N14	N13	N12	N11	N10	N9	N8	A
Divider Byte 2	D2	N7	N6	N5	N4	N3	N2	N1	N0	A
Control Byte	CB	1	CP	T2	T1	T0	RD1	RD0	x	A
Band switch Byte	BB	x	x	x	x	BS3	BS2	BS1	BS0	A

- Data specifications

x : don't care ;"0" or "1"

CA1, CA0 : Programmable address bits

ADRS Voltage	CA1	CA0
Always valid	0	1
0 to 0.1 Vcc1	0	0
0.4 Vcc1 to 0.6 Vcc1	1	0
0.9 Vcc1 to Vcc1	1	1

BS0 to BS3 : Band switch buffers Control bits, BS<sub>n</sub>=1 then "ON"

N0 to N14 : Control of Programmable divider bits, N14=MSBN0=LSB

Dividing ratio :  $N=214 \times N14 + 213 \times N13 + \dots + 21 \times N1 + N0$

Maximum division ratio 32767

Minimum division ratio 256

CP : Charge Pump Current

CP	Charge Pump Current	Conditions
1	280uA	Normal, Default
0	60uA	Test

T0 to T2 : Test mode bits

T0, T1, T2 : Phase Comparator Output bits

T2	T1	T0	Phase Comparator, Band Switch	Conditions
0	0	x	Normal Output	Normal, Default
1	0	1	Phase Comparator (High Impedance)	Test
1	1	0	Phase Comparator (Sink)	
1	1	1	Phase Comparator (Source)	

RD1, RD0 : Reference Divider bits

RD1	RD2	Reference Divider	Conditions
x	0	640	Default
1	1	512	
0	1	1024	

(Note)

Default : Power on reset

■ TERMINAL CHARACTERISTICS

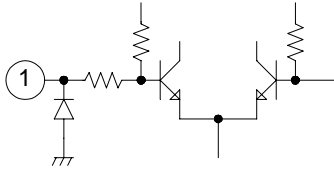
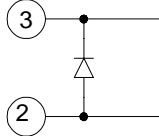
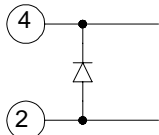
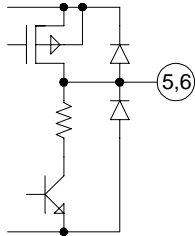
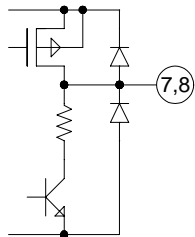
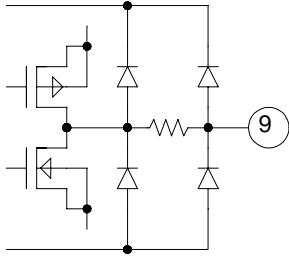
No.	Symbol	Typ.DC Voltage (V)	Equivalent Circuit	Function
1	HF	3.2		High Frequency Signal Input
2	GND	0		GND
3	Vcc1	5		Power Supply
4	Vcc3	5		Band Switch Power Supply
5 6	BS3 BS2	0		Band Switch (Typ: 7.5mA)
7 8	BS1 BS0	0		Band Switch (Typ: 15mA)
9	CP	-		Charge Pump Output

No.	Symbol	Typ.DC Voltage (V)	Equivalent Circuit	Function
10	AMPOUT	-		Amplifier Output
11	Vcc2	3.4		Amplifier Power Supply
12	OSCOUT	4.1		Reference Oscillator Output
13	SCL	-		SCL Input (I <sup>2</sup> C bus)
14	SDA	-		SDA Input (I <sup>2</sup> C bus)
15	ADRS	-		ADRS Input (I <sup>2</sup> C bus)
16	XTAL	3.3		Crystal Input

■ TYPICAL CHARACTERISTICS

VCC1 Supply Current Curve

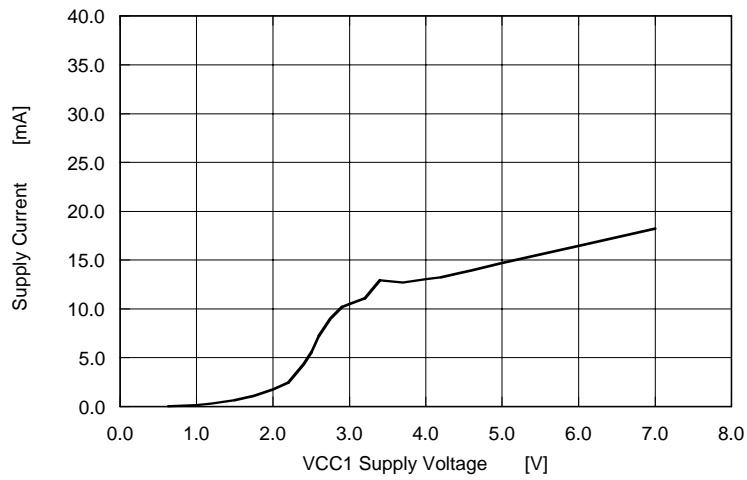

BS0-BS1 Output Current Curve

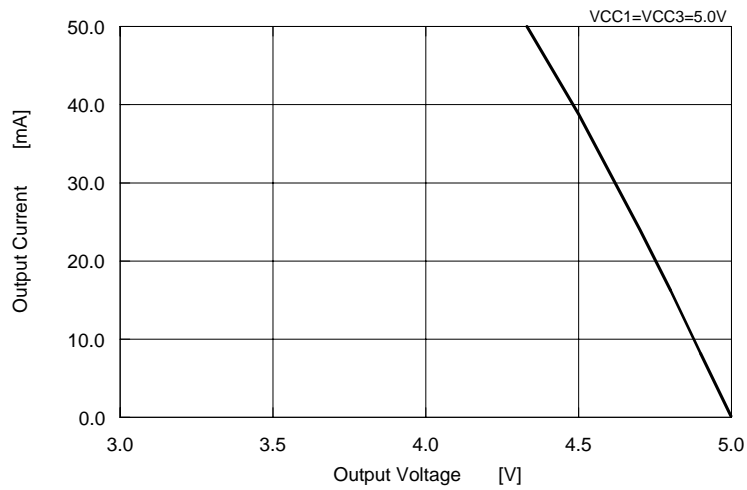

BS3 Output Current Curve

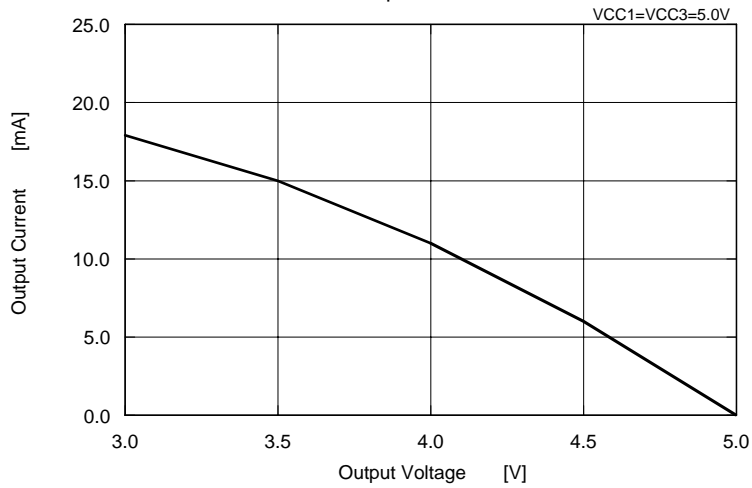



■ TEST CIRCUIT

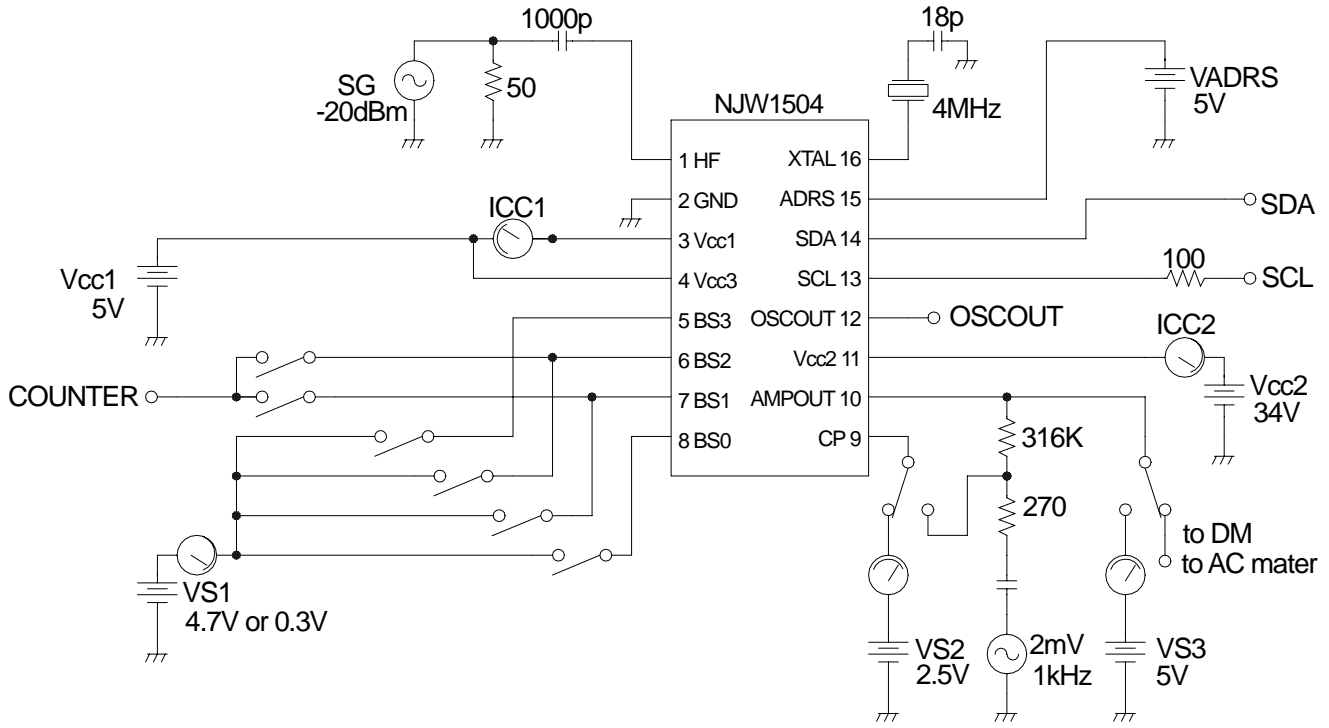

[CAUTION]  
 The specifications on this databook are only given for information, without any guarantee as regards either mistakes or omissions. The application circuits in this databook are described only to show representative usages of the product and not intended for the guarantee or permission of any right including the industrial rights.