

## CONSTANT CURRENT LED DRIVER with PWM CONTROL

### ■ GENERAL DESCRIPTION

The NJU6080 is a constant current LED driver with PWM control.

NJU6080 can reduce board density compared with the case composed discrete because the constant current value can be set with one resistance.

It can contribute to the reliability improvement of the system because it has an over current protection circuit and thermal shutdown circuit.

The NJU6080 is suited for a LCD back light and toys, etc.

### ■ PACKAGE OUTLINE

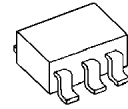

NJU6080F1

### ■ FEATURES

- Supply Voltage Range : 2.5V ~ 5.5V
- LED Output Current : 100mA ( max. )
- Output Current Accuracy :  $\pm 1.8\%$
- Operating Current : 150 $\mu$ A ( typ. )
- One white LED can be lit.
- External Parts : Current limitation resistance
- Internal Thermal Overload Protection
- Internal Over Current Protection
- CMOS Technology
- Package Outline : SOT-23-6

### ■ BLOCK DIAGRAM

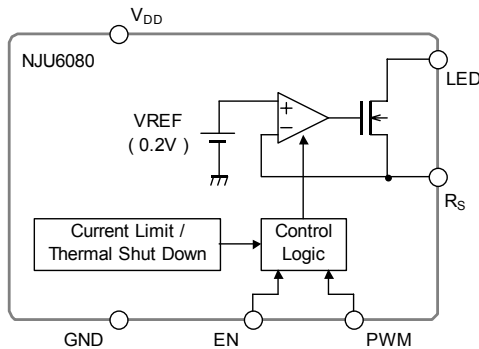

### ■ PIN CONFIGURATION

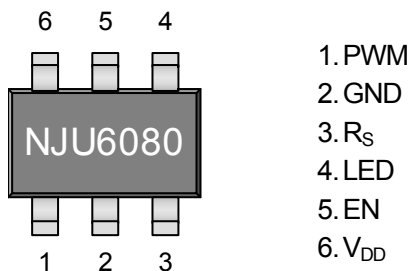

## ■ ABSOLUTE MAXIMUM RATINGS

( $T_a = 25^\circ\text{C}$ )

PARAMETER	SYMBOL	RATINGS	UNIT
Supply Voltage	$V_{DD}$	- 0.3 ~ + 7.0	V
Output Voltage	$V_{LED}$	- 0.3 ~ + 7.0	V
Output Current	$I_{LED}$	200	mA
EN Pin Voltage	$V_{EN}$	+ 7.0 (*1)	V
PWM Pin Voltage	$V_{PWM}$	+ 7.0 (*1)	V
Power Dissipation	$P_D$	400 (*2)	MW
Operating Temperature	$T_{opr}$	- 40 ~ + 85	$^\circ\text{C}$
Storage Temperature	$T_{stg}$	- 40 ~ + 125	$^\circ\text{C}$

(\*1) : When input voltage is less than +7V, the absolute maximum control voltage is equal to the input voltage.

(\*2) : Mounted on glass epoxy board ( 76.2 × 114.3 × 1.6mm: 2Layers FR-4 )

## ■ RECOMMENDED OPERATING CONDITION

( $T_a = 25^\circ\text{C}$ )

PARAMETER	SYMBOL	CONDITIONS	MIN.	TYP.	MAX.	UNIT
Supply Voltage	$V_{DD}$		2.5	-	5.5	V
Output Voltage	$V_{LED}$		-	-	5.5	V

## ■ ELECTRICAL CHARACTERISTICS

( $V_{DD} = 3.0\text{V}$ ,  $V_{LED} = 0.5\text{V}$ ,  $R_S = 10\Omega$ ,  $V_{EN} = V_{PWM} = V_{DD}$ ,  $T_a = 25^\circ\text{C}$ )

PARAMETER	SYMBOL	CONDITIONS	MIN.	TYP.	MAX.	UNIT
Quiescent Current	$I_{DD}$		-	150	260	$\mu\text{A}$
Quiescent Current at OFF	$I_{DD\_OFF}$	$V_{EN} = \text{GND}$	-	-	0.1	$\mu\text{A}$
Output Current Accuracy	$\Delta I_{LED}$		- 1.8	-	+ 1.8	%
Output Pin Voltage 1	$V_{LED1}$	$I_{LED} = 20\text{mA}$	-	0.3	0.4	V
Output Pin Voltage 2	$V_{LED2}$	$I_{LED} = 100\text{mA}$	-	0.4	0.5	V
Output Pin Leak Current 1	$I_{LEAK1}$	$V_{EN} = \text{GND}$ , $V_{DD} = V_{LED} = 5.5\text{V}$	-	-	0.1	$\mu\text{A}$
Output Pin Leak Current 2	$I_{LEAK2}$	$V_{PWM} = \text{GND}$ , $V_{DD} = V_{LED} = 5.5\text{V}$	-	-	0.1	$\mu\text{A}$
EN Pin ON Voltage	$V_{EN\_ON}$	$I_{LED} = \text{OFF} \rightarrow \text{ON}$	1.6	-	$V_{DD}$	V
EN Pin OFF Voltage	$V_{EN\_OFF}$	$I_{LED} = \text{ON} \rightarrow \text{OFF}$	0	-	0.3	V
PWM Pin ON Voltage	$V_{PWM\_ON}$	$I_{LED} = \text{OFF} \rightarrow \text{ON}$	$0.7V_{DD}$	-	$V_{DD}$	V
PWM Pin OFF Voltage	$V_{PWM\_OFF}$	$I_{LED} = \text{ON} \rightarrow \text{OFF}$	0	-	$0.3V_{DD}$	V
EN Pin Input Current	$I_{EN}$		-	-	0.1	$\mu\text{A}$
PWM Pin Input Current	$I_{PWM}$		-	-	0.1	$\mu\text{A}$
$R_S$ Pin Leak Current	$I_{LEAK\_RS}$	$V_{EN} = \text{GND}$ , $V_{RS} = V_{LED} = 3\text{V}$	-	-	0.1	$\mu\text{A}$
PWM Pin ON Delay Time	$t_{PWM\_ON}$	$V_{PWM} = \text{L} \rightarrow \text{H}$	-	2.5	-	$\mu\text{s}$
PWM Pin OFF Delay Time	$t_{PWM\_OFF}$	$V_{PWM} = \text{H} \rightarrow \text{L}$	-	0.1	-	$\mu\text{s}$
Maximum Output Current	$I_{LED\_MAX}$	$R_S = 0\Omega$	100	200	-	mA

## ■ APPLICATION CIRCUIT

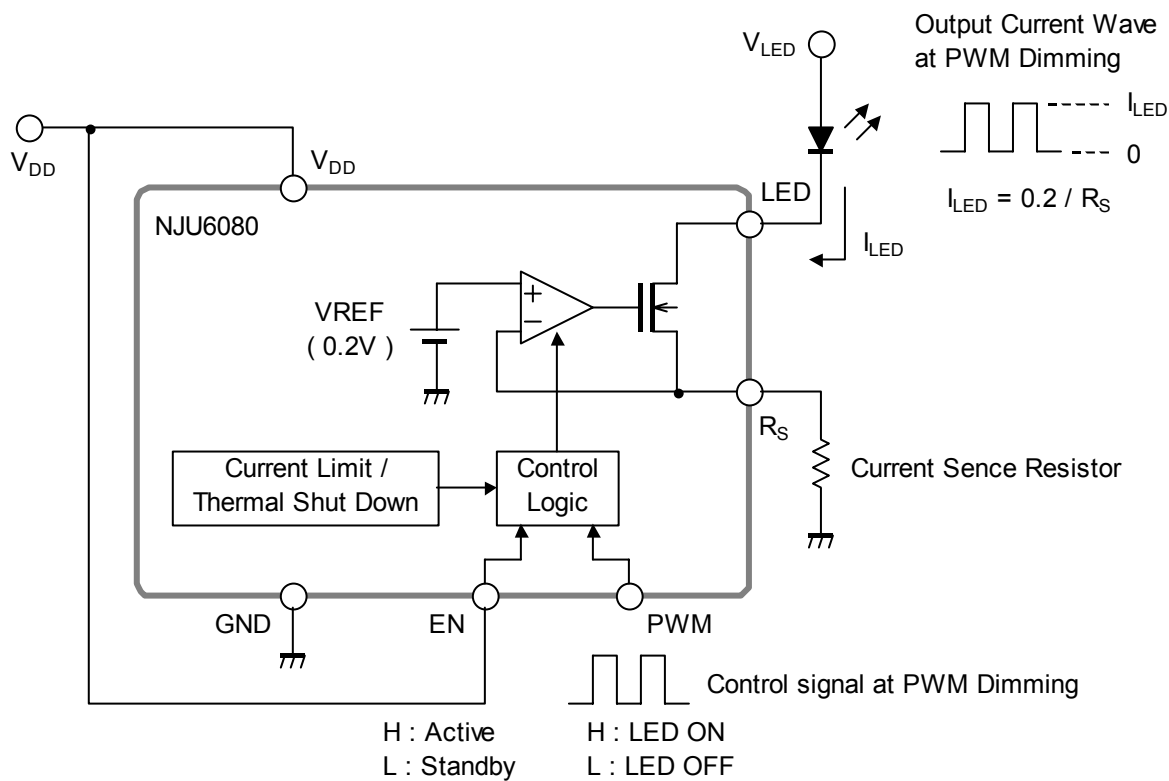

## ■ TYPICAL CHARACTERISTICS

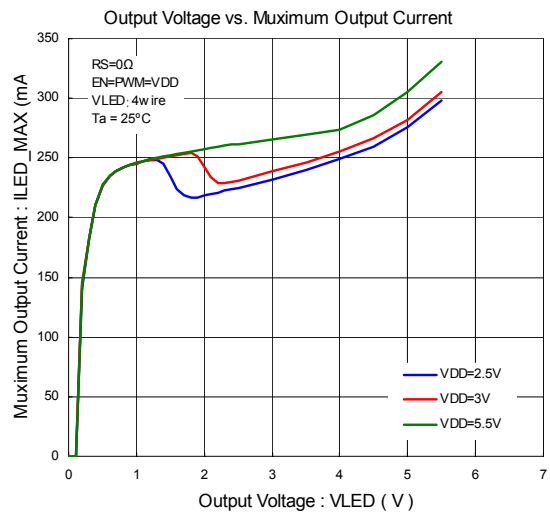
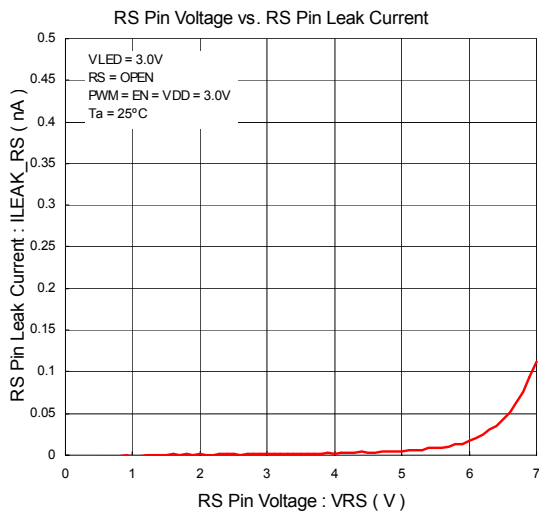
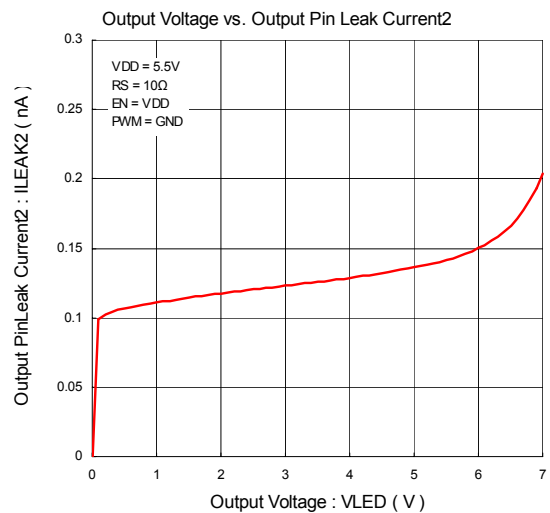
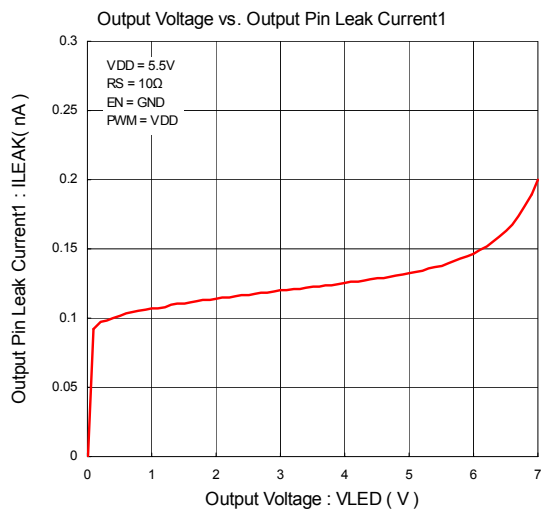
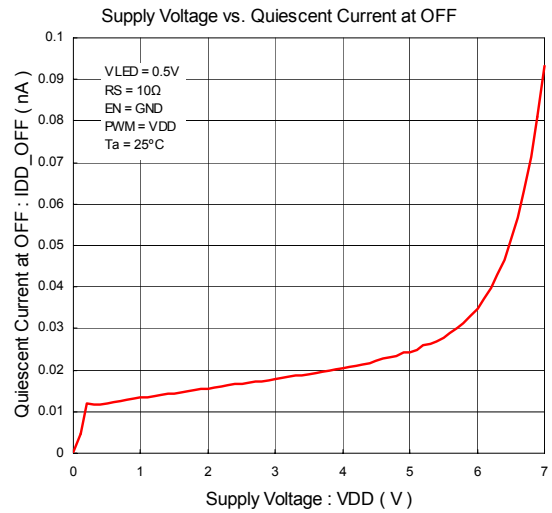
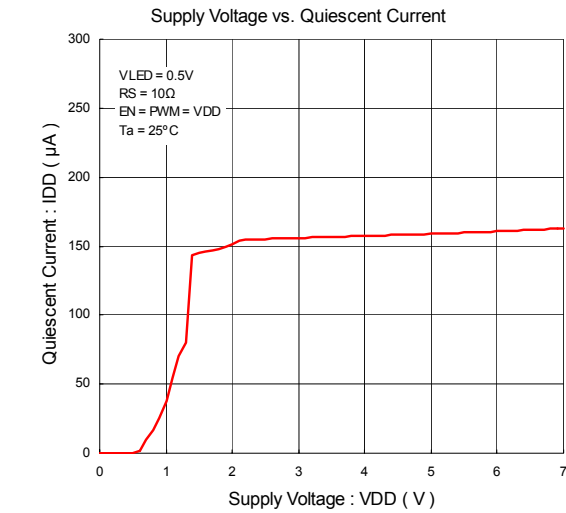

## ■ TYPICAL CHARACTERISTICS

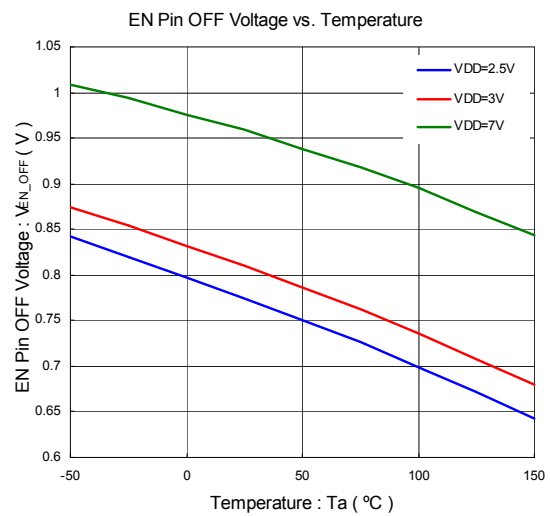
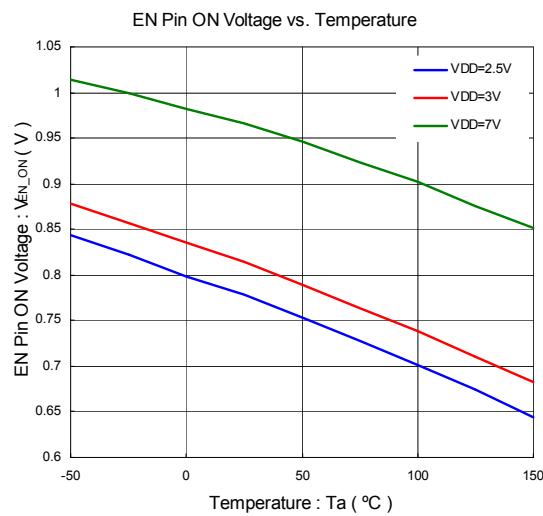
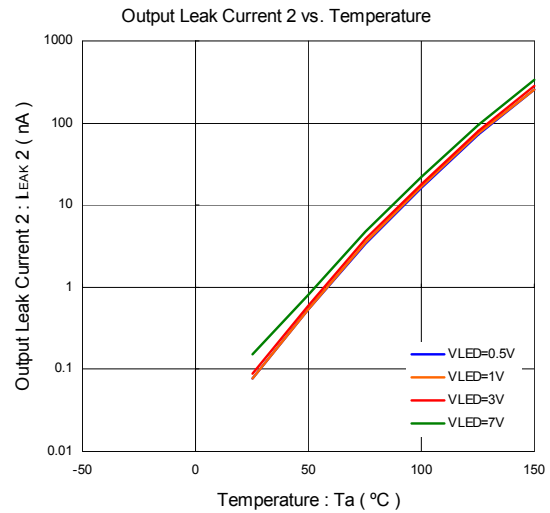
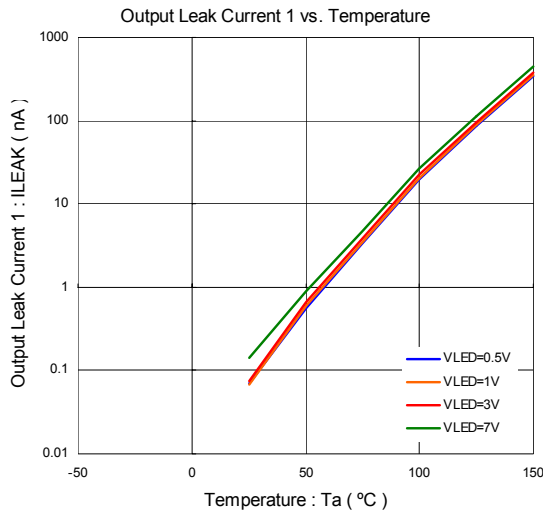
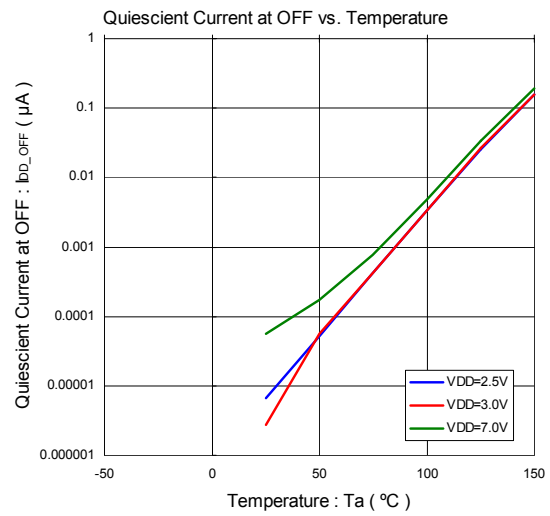
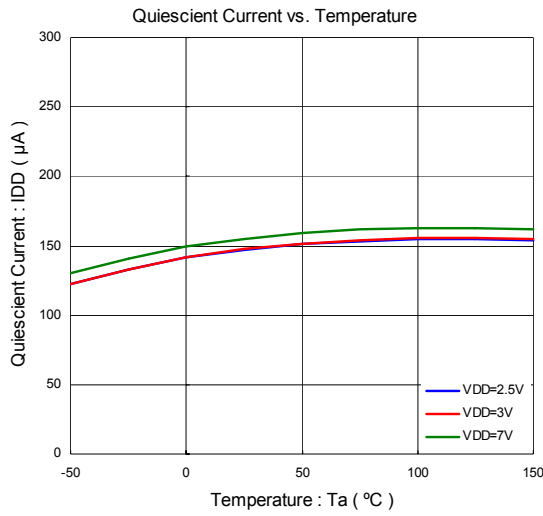

## ■ TYPICAL CHARACTERISTICS

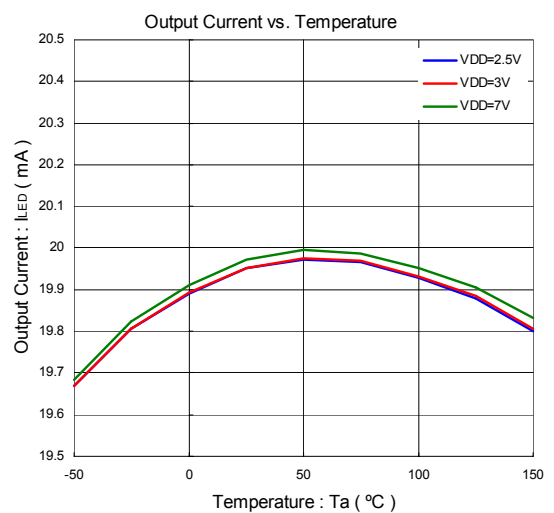
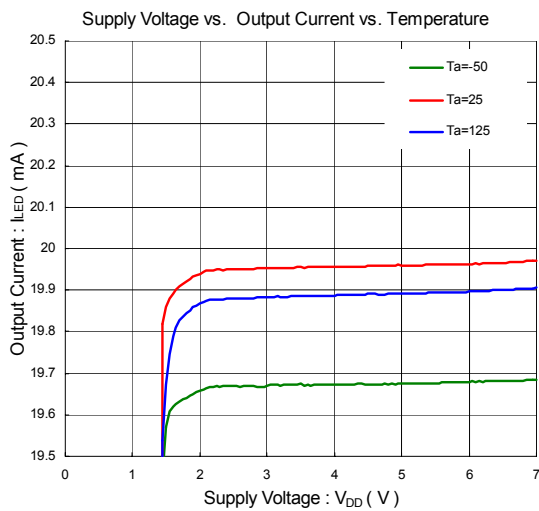
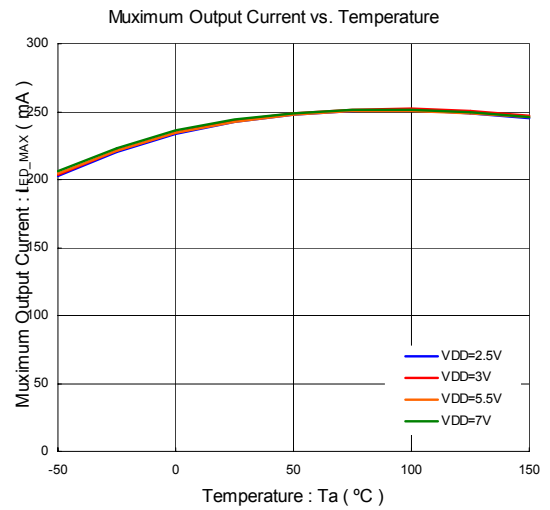
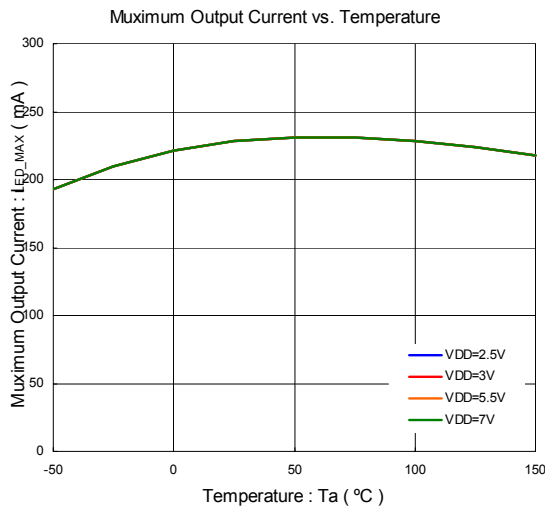
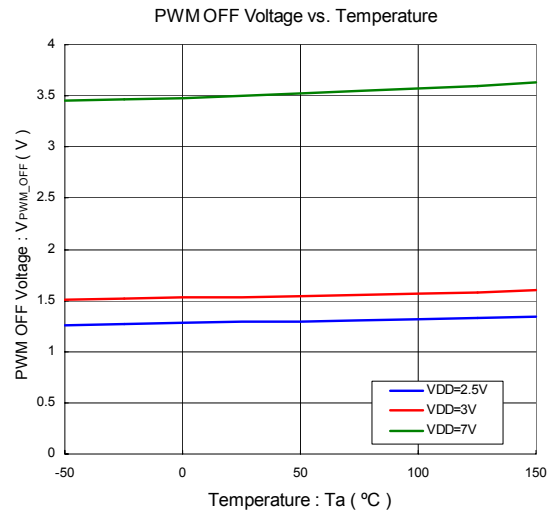
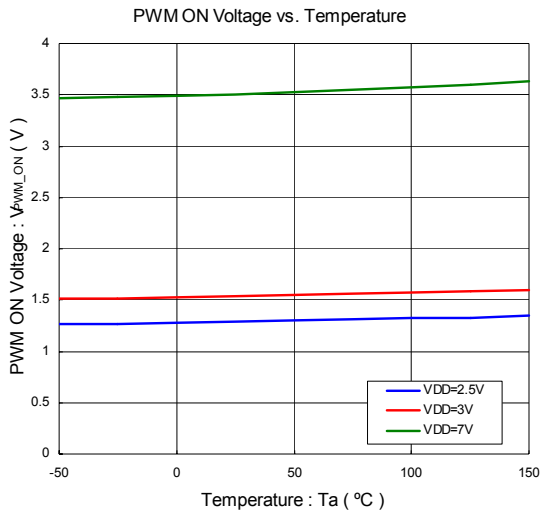

## ■ TYPICAL CHARACTERISTICS

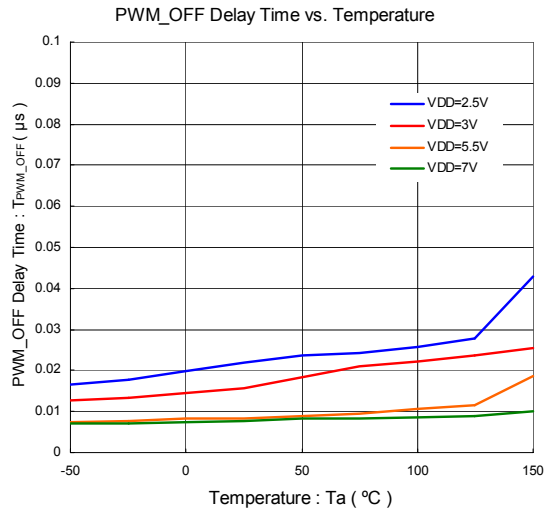
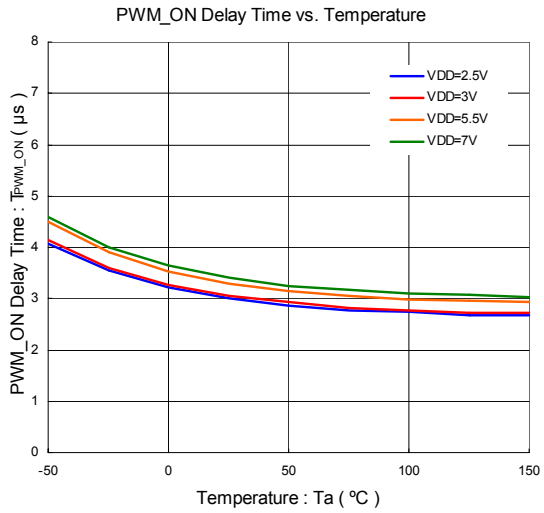
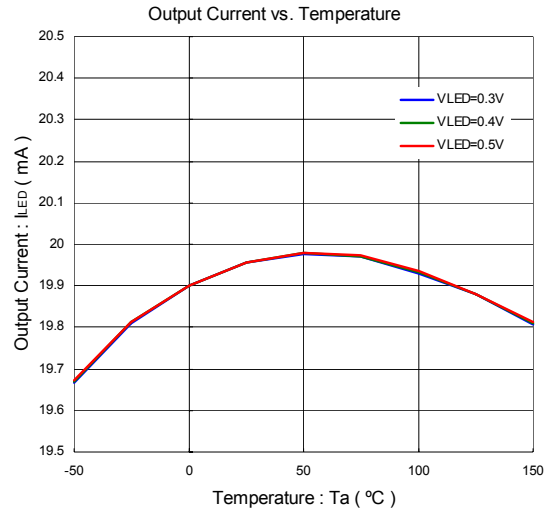
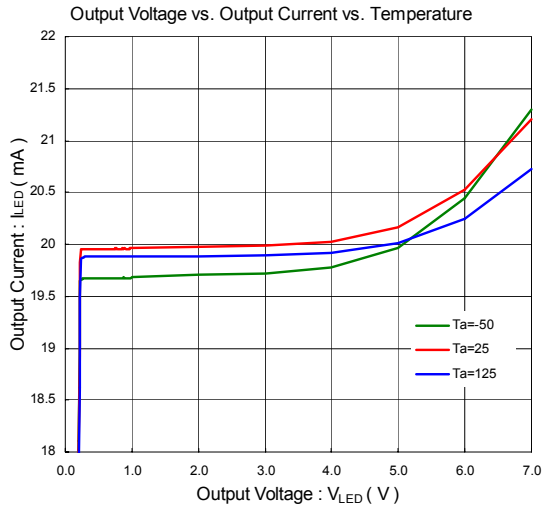

**[CAUTION]**

The specifications on this databook are only given for information, without any guarantee as regards either mistakes or omissions. The application circuits in this databook are described only to show representative usages of the product and not intended for the guarantee or permission of any right including the industrial rights.