

3OUTPUT LOW DROPOUT VOLTAGE REGULATOR

■ GENERAL DESCRIPTION

The NJM2893 is a 3-channel low dropout voltage regulator featuring a low noise, high precision of $\pm 1.0\%$, high ripple rejection ratio of 75dB, and 100mA output current (all outputs). It has an ON/OFF function which reduces the quiescent current on stand-by mode. Further the NJM2893 is available in a small and thin surface mount 8-lead MSOP (TVSP) package, and it can use ceramic capacitor of $1\mu\text{F}$ as an output capacitor. Therefore it can achieve a high-density mounting and is suitable for small precision devices, portable devices and others.

■ PACKAGE OUTLINE



NJM2893RB1
(MSOP8 (TVSP8))

■ FEATURES

- High Ripple Rejection 75dB typ. (f=1kHz, Vo=3V Version)
- Output Noise Voltage Vno=45 μV rms typ.
- Output capacitor with 1.0 μF ceramic capacitor (Vo \geq 2.7V)
- Output Current Io(max.)=100mA x3
- High Precision Output Vo \pm 1.0%
- Low Dropout Voltage 0.10V typ. (Io=60mA)
- ON/OFF Control (Active High)
- Internal Short Circuit Current Limit
- Internal Thermal Overload Protection
- Bipolar Technology
- Package Outline MSOP8 (TVSP8)* *MEET JEDEC MO-187-DA / THIN TYPE

■ PIN CONFIGURATION

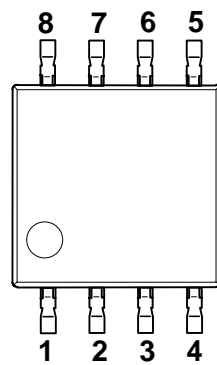

PIN FUNCTION

- 1. V_{OUT1}
- 2. V_{OUT2}
- 3. V_{OUT3}
- 4. GND
- 5. CONTROL3
- 6. CONTROL2
- 7. CONTROL1
- 8. V_{IN}

NJM2893RB1

■ EQUIVALENT CIRCUIT

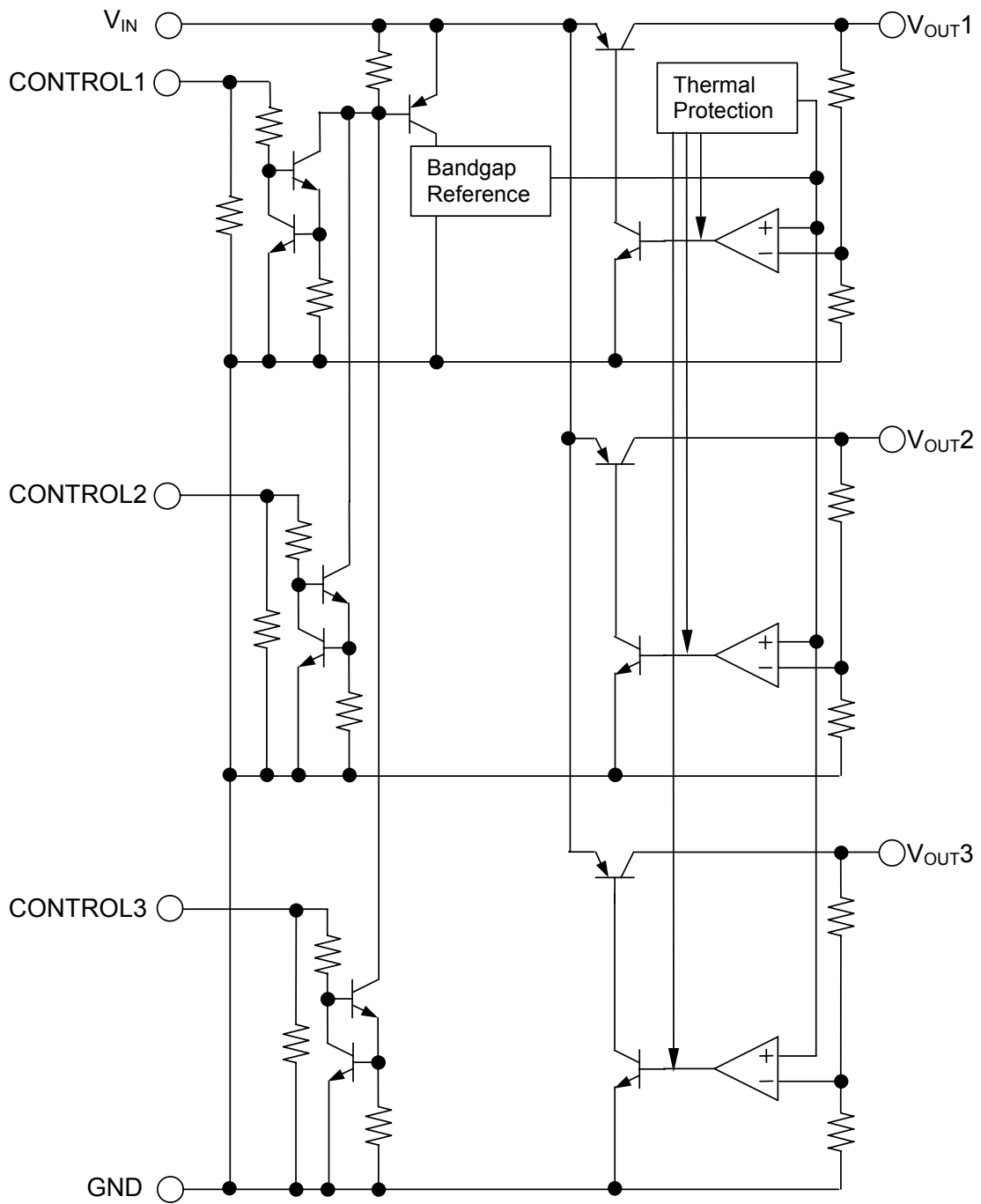

■ OUTPUT VOLTAGE RANK LIST

Device Name	Vout		
	CH1	CH2	CH3
NJM2893RB1-CCC	2.1V	2.1V	2.1V
NJM2893RB1-LLL	3.0V	3.0V	3.0V
NJM2893RB1-YLC	5.0V	3.0V	2.1V

■ ABSOLUTE MAXIMUM RATINGS (Ta=25°C)

PARAMETER	SYMBOL	RATINGS	UNIT
Input Voltage	V _{IN}	+14	V
Control Voltage	V _{CONT}	+14(*1)	V
Power Dissipation	P _D	320	mW
Operating Temperature	Topr	-40 to +85	°C
Storage Temperature	Tstg	-40 to +125	°C

(*1) When input voltage is less than +14V, the absolute maximum control voltage is equal to the input voltage.

■ ELECTRICAL CHARACTERISTICS

(V_{IN}=Vo+1V, C_{IN}=0.1μF, Co=1.0uF: Vo≥2.7V (Co=2.2uF: Vo≤2.6V), Ta=25°C)

PARAMETER	SYMBOL	TEST CONDITION	MIN.	TYP.	MAX.	UNIT
Output Voltage	Vo	Io=30mA	-1.0%	-	+1.0%	V
Quiescent Current1	I _{Q1}	V _{CONT1} =V _{IN} , V _{CONT2} =V _{CONT3} =0V *1ch ON Io=0mA, expect Icont	-	150	220	μA
Quiescent Current2	I _{Q2}	V _{CONT1} =V _{CONT2} =V _{IN} , V _{CONT3} =0V *2ch ON Io=0mA, expect Icont	-	270	400	μA
Quiescent Current3	I _{Q3}	V _{CONT1} =V _{CONT2} =V _{CONT3} =V _{IN} Io=0mA, expect Icont	-	390	580	μA
Quiescent Current at Control OFF	I _{Q(OFF)}	V _{CONT} =0V	-	-	100	nA
Output Current	Io	Vo-0.3V	150	200	-	mA
Line Regulation	ΔVo/ΔV _{IN}	V _{IN} =Vo+1V to Vo+6V, Io=30mA	-	-	0.10	%/V
Load Regulation	ΔVo/ΔIo1	Io=0 to 100mA	-	-	0.03	%/mA
Dropout Voltage	ΔV _{L-O1}	Io=60mA	-	0.10	0.18	V
Ripple Rejection	RR	ein=200mVrms, f=1kHz, Io=10mA, Vo=3V Version	-	75	-	dB
Average Temperature Coefficient of Output Voltage	ΔVo/ΔTa	Ta=0 to 85°C, Io=10mA	-	±50	-	ppm/°C
Output Noise Voltage	V _{NO}	f=10Hz to 80kHz, Io=10mA, Vo=3V Version	-	45	-	μVrms
Control Voltage for ON-state	V _{CONT(ON)}		1.6	-	-	V
Control Voltage for OFF-state	V _{CONT(OFF)}		-	-	0.6	V

(*2) V_{IN} =Vo+1V means add 1V to higher output voltage.

The above specification is a common specification for all output voltages.

Therefore, it may be different from the individual specification for a specific output voltage.

■ TEST CIRCUIT

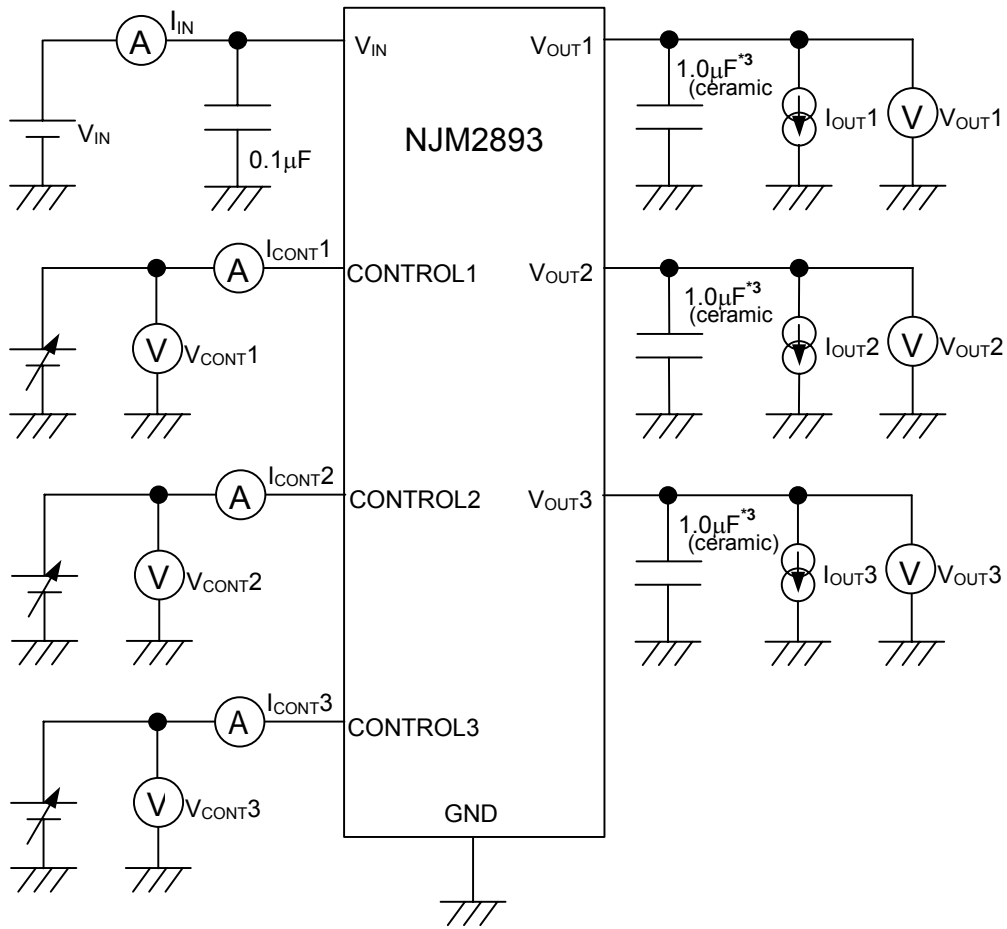

*3 $V_o \leq 2.6V$ version: $C_o = 2.2\mu F$ (ceramic)

■ TYPICAL APPLICATION

① In the case where ON/OFF Control is not required:

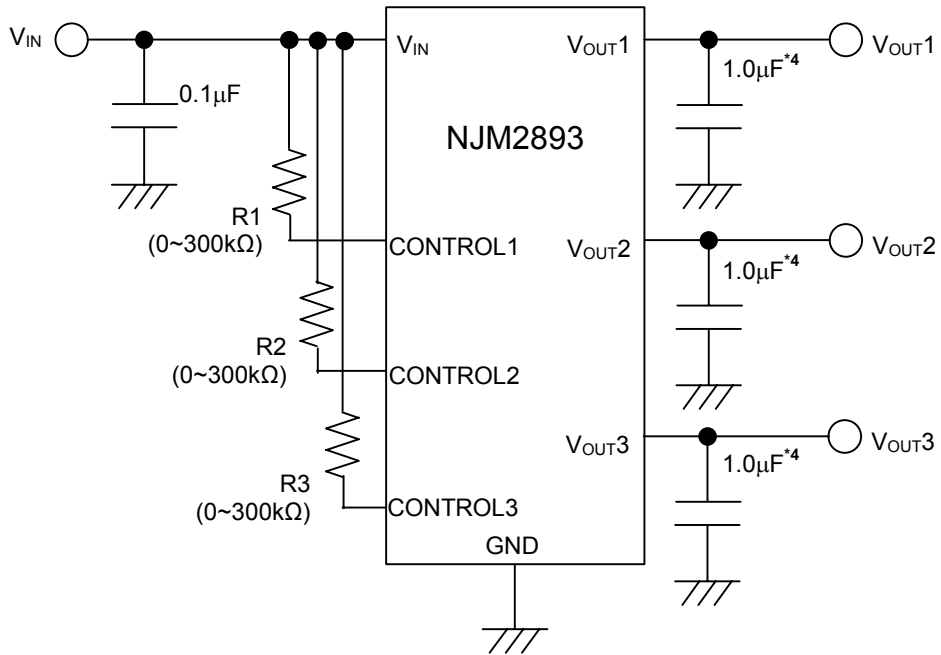

*4 $V_o \leq 2.6V$ version: $C_o = 2.2\mu F$

Connect control terminal to V_{IN} terminal

② In use of ON/OFF CONTROL:

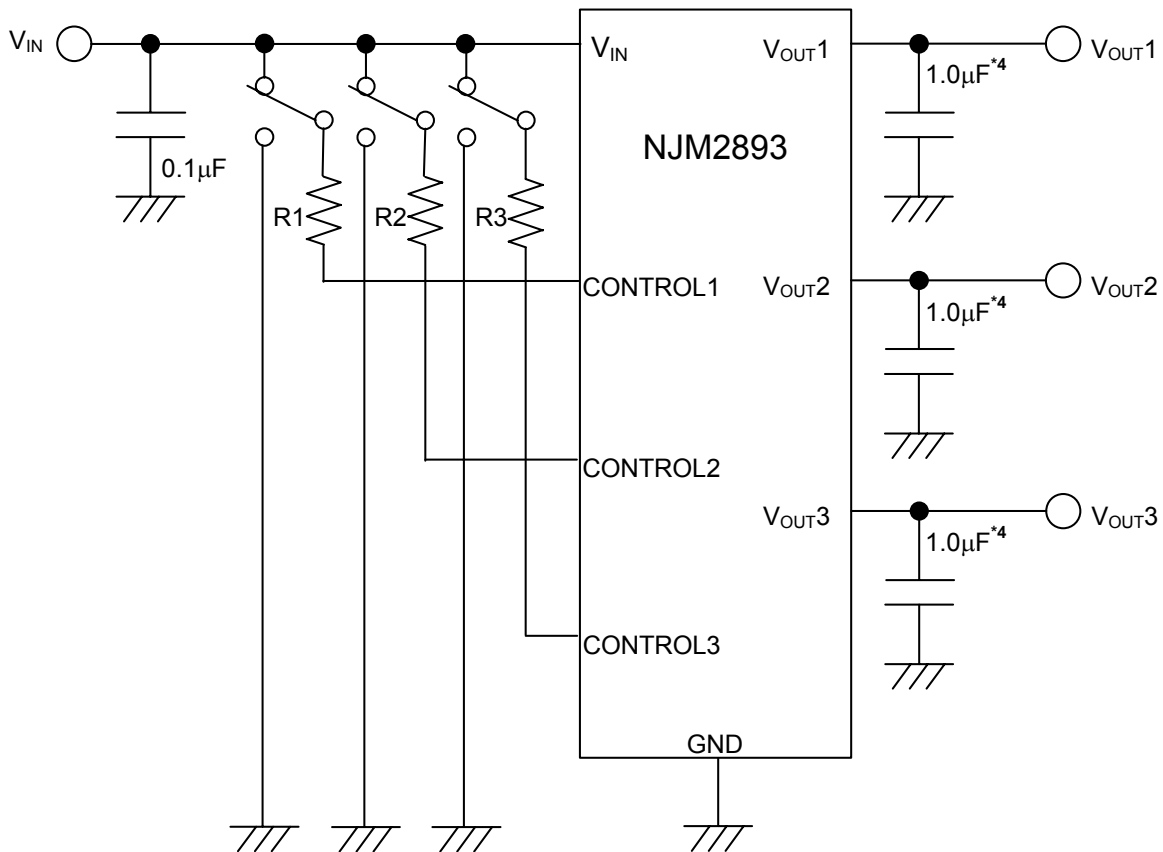

*4 $V_o \leq 2.6V$ version: $C_o = 2.2\mu F$

State of control terminal:

- “H” → output is enabled.
- “L” or “open” → output is disabled.

*In the case of using a resistance "R" between V_{IN} and control.

The current flow into the control terminal while the IC is ON state (I_{CONT}) can be reduced when a pull up resistance "R" is inserted between V_{IN} and the control terminal.

The minimum control voltage for ON state ($V_{CONT(ON)}$) is increased due to the voltage drop caused by I_{CONT} and the resistance "R". The I_{CONT} is temperature dependence as shown in the "Control Current vs. Temperature" characteristics. Therefore, the resistance "R" should be carefully selected to ensure the control voltage exceeds the $V_{CONT(ON)}$ over the required temperature range.

ELECTRICAL CHARACTERISTICS

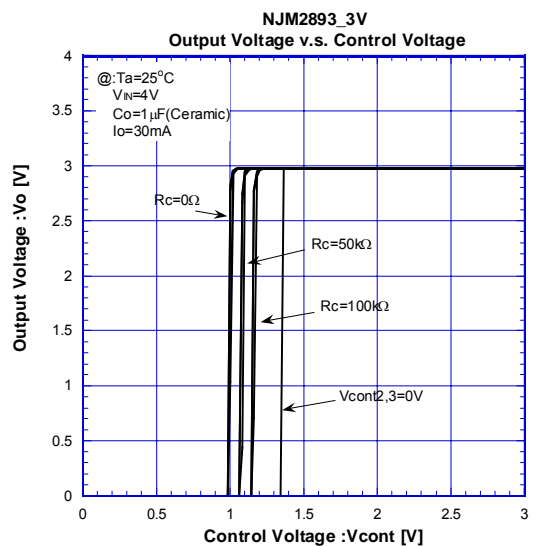
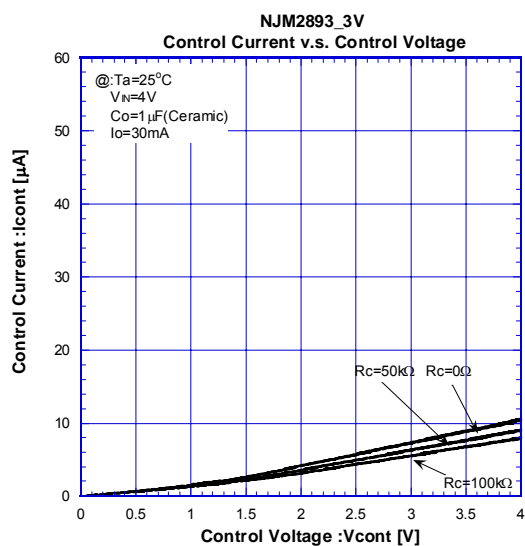
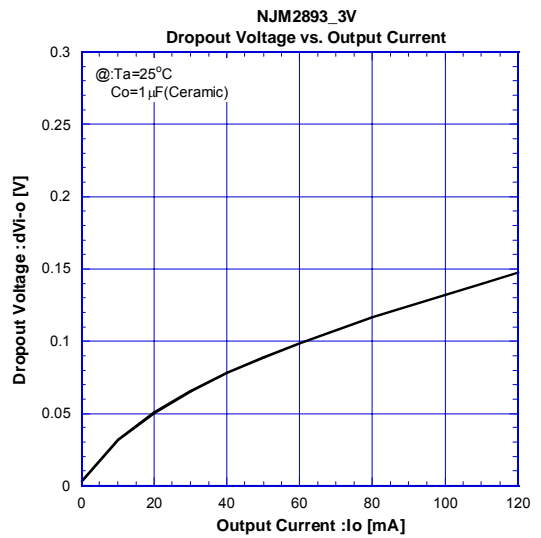
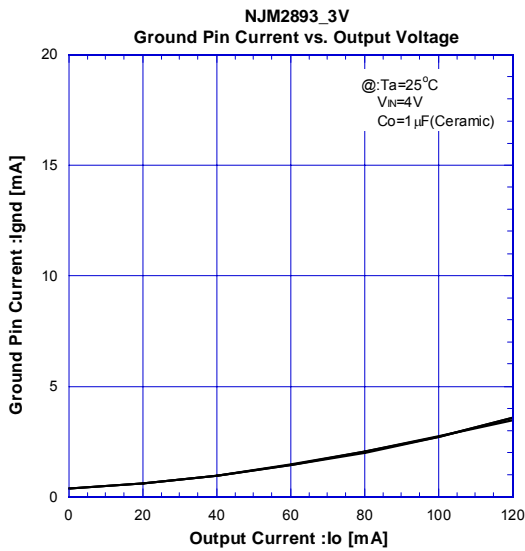
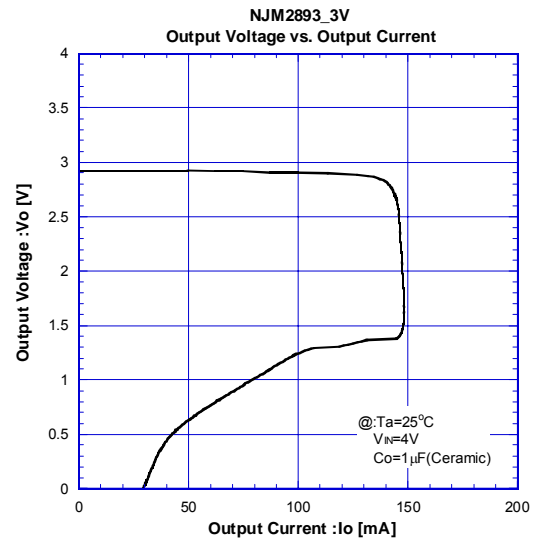
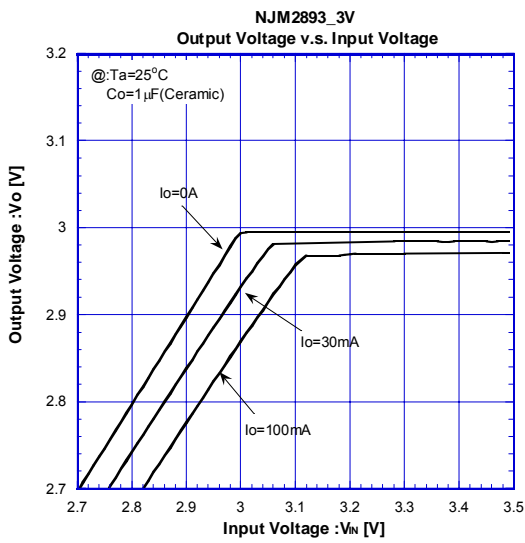

ELECTRICAL CHARACTERISTICS

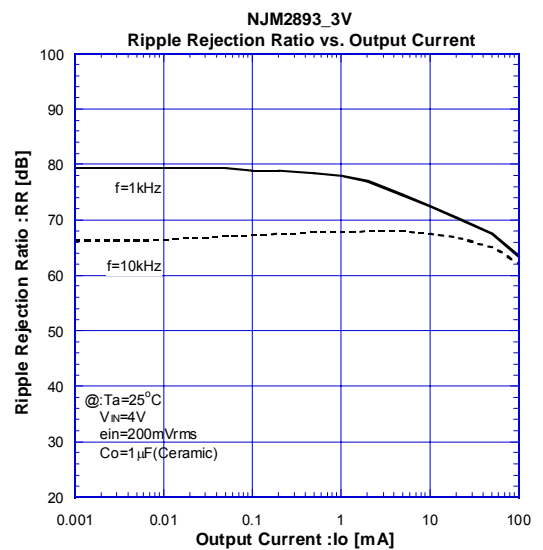
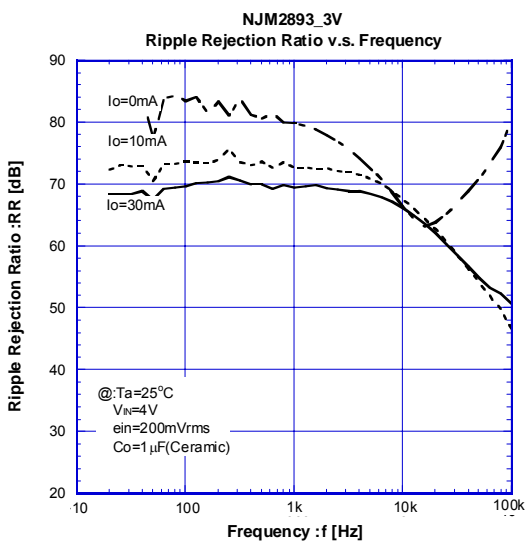
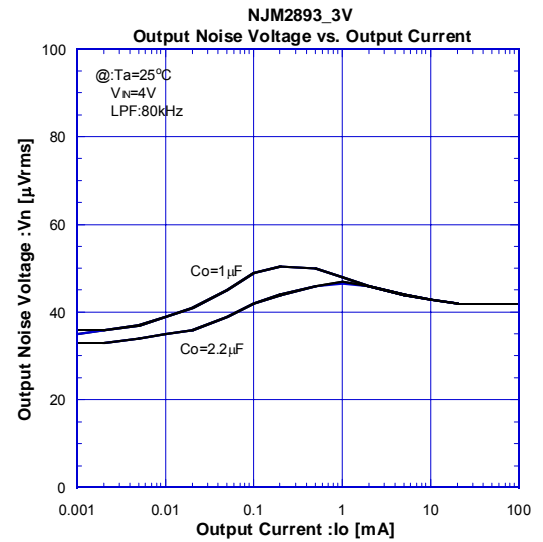
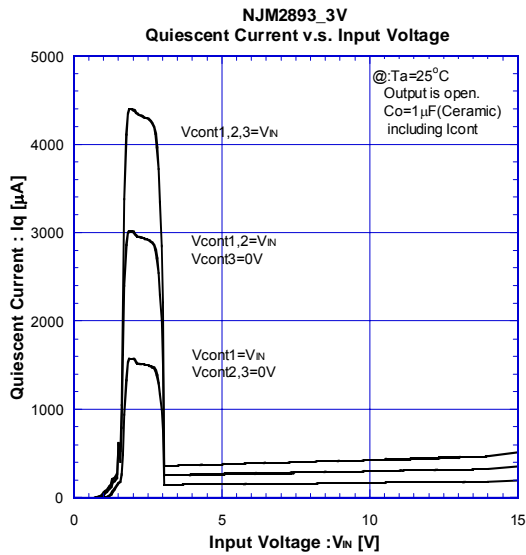
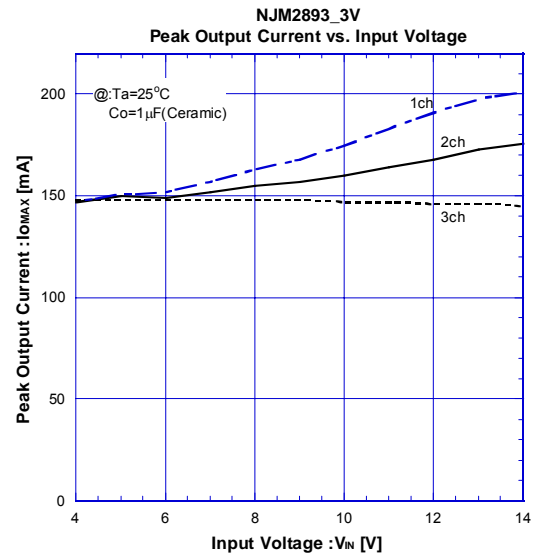
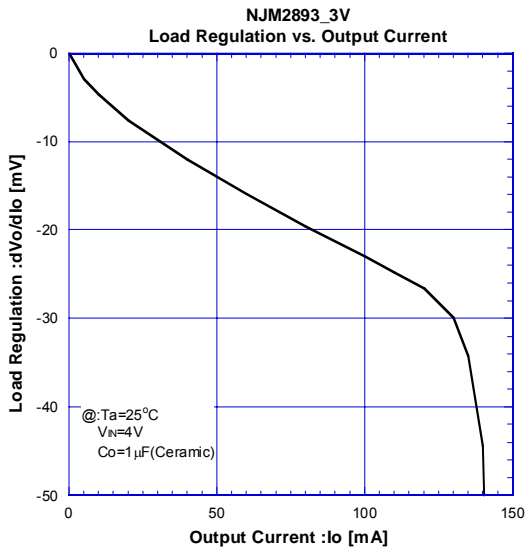

ELECTRICAL CHARACTERISTICS

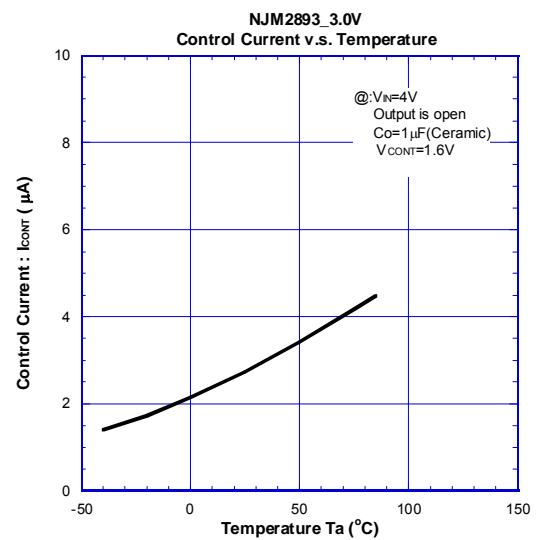
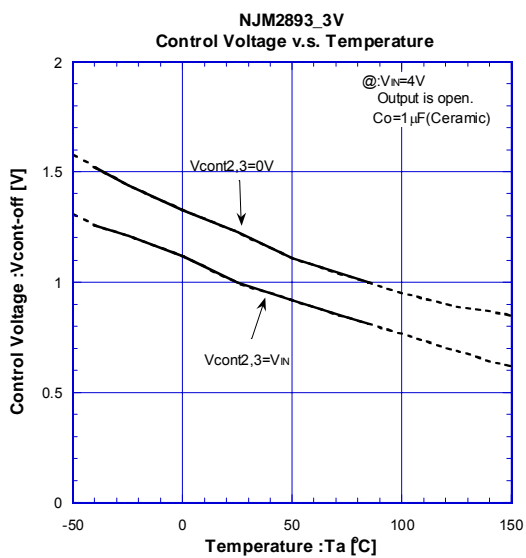
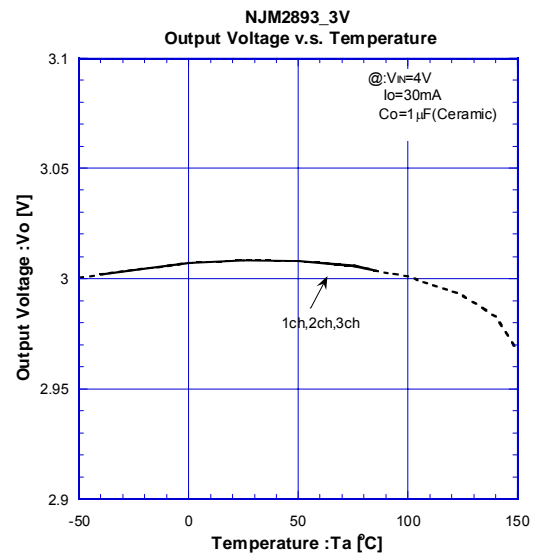
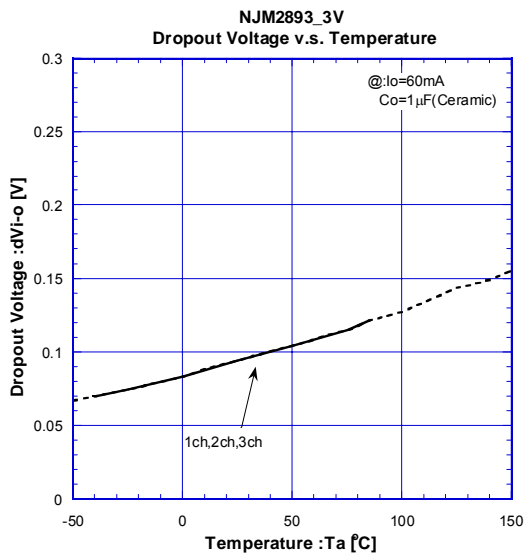
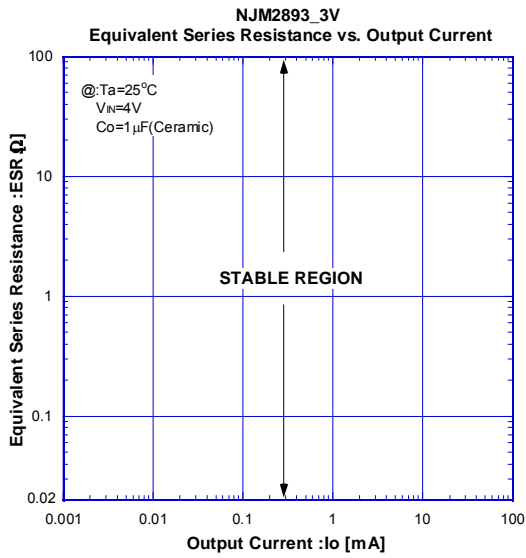

ELECTRICAL CHARACTERISTICS

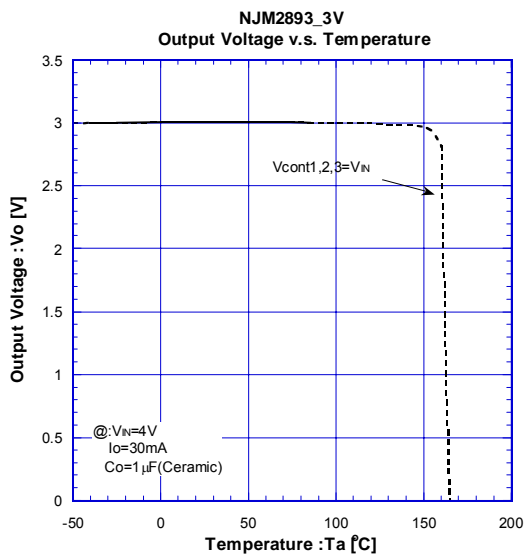
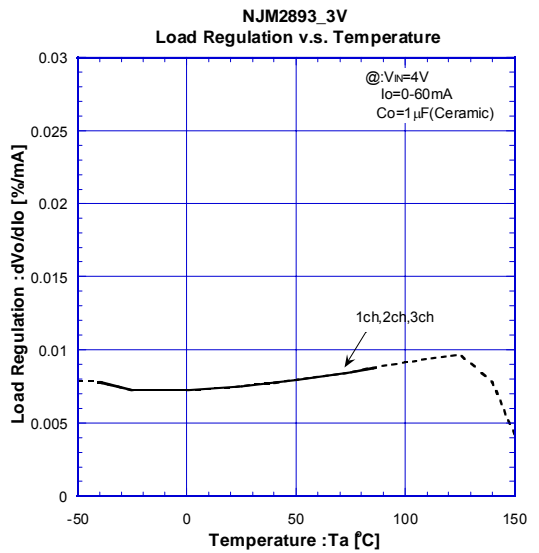
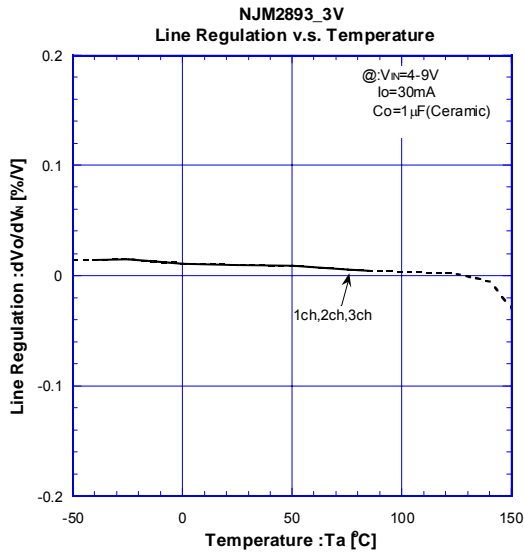
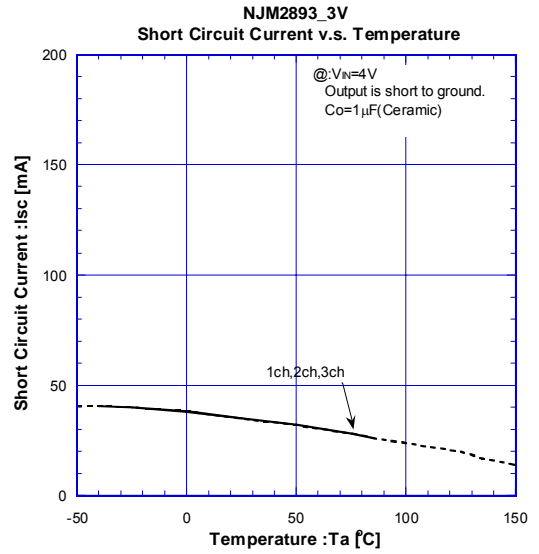
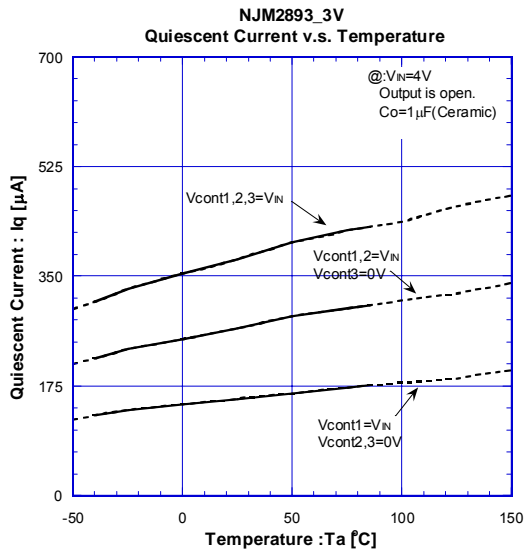

■ ELECTRICAL CHARACTERISTICS

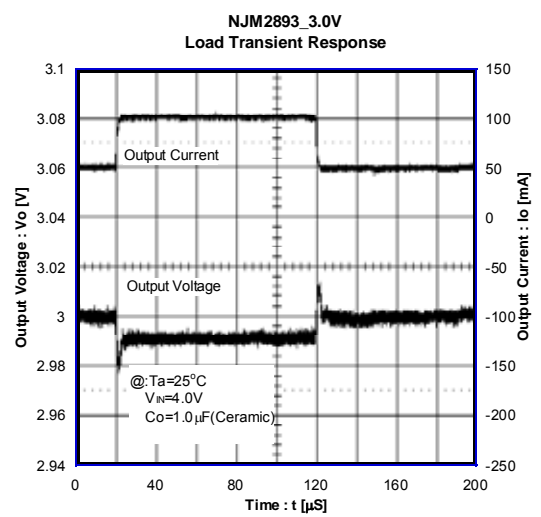
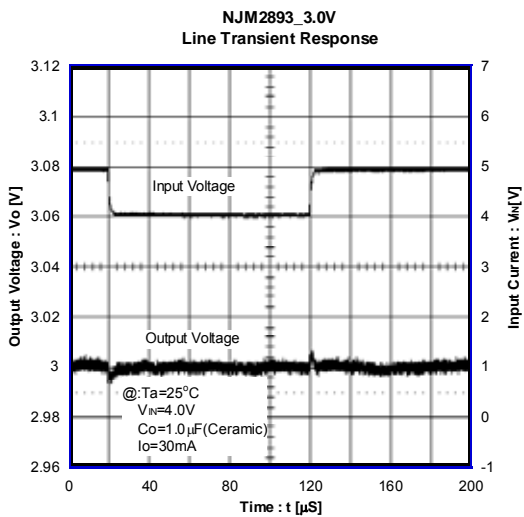
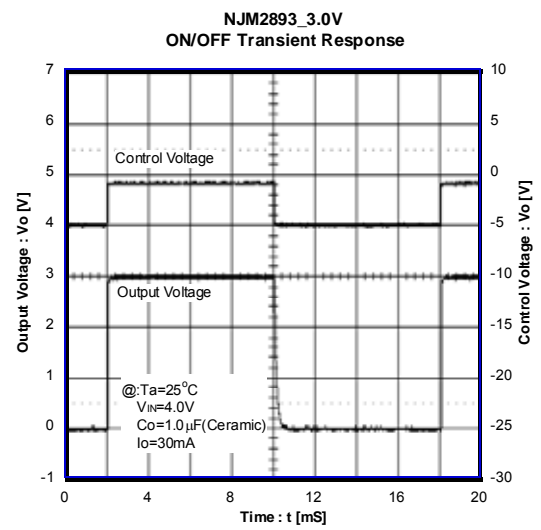
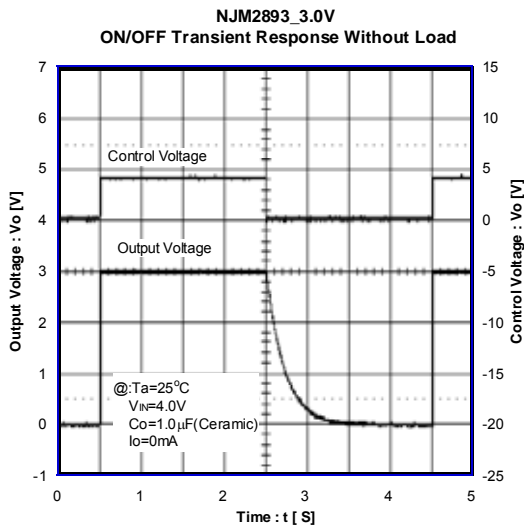

[CAUTION]

The specifications on this databook are only given for information, without any guarantee as regards either mistakes or omissions. The application circuits in this databook are described only to show representative usages of the product and not intended for the guarantee or permission of any right including the industrial rights.