



Rail-to-Rail Output, High Quality Audio, Dual Operational Amplifier

■ GENERAL DESCRIPTION

The MUSES8832 is a Rail-to-Rail output High quality audio operational amplifier, which is optimized for high-end audio and portable audio applications.

The MUSES8832 features 2.1nV/√Hz low noise, 10MHz wide gain bandwidth, 0.0009% low distortion, 600Ω drive capability, -40°C to +125°C operating temperature range, and various reliabilities and conveniences are improved.

It is the best for audio preamplifiers, active filters, microphone amplifiers, and line amplifiers with excellent sound.

■ FEATURES

- Operating Voltage +2.7V to +14V
 ±1.35V to ±7.0V
- Low Noise 2.1nV/√Hz typ. at f=1kHz
 0.3μVrms typ. (20Hz to 20kHz)
- Output Current 32mA typ. (Capability of driving 600Ω loads)
- GBW 10MHz typ.
- Low Distortion 0.0009% typ. at V₊=+5V, V_o=1.3Vrms
- Slew Rate 1V/μs typ.
- Bipolar Technology
- Package Outline SOP8 JEDEC 150 mil, SSOP8-A3
 DFN8-W1 (ESON8-W1) (3.0mm x 3.0mm)
- Operating Temperature Range -40 to +125°C

■ APPLICATIONS

- Portable Audio
- Home Audio
- PC Audio
- Car Audio

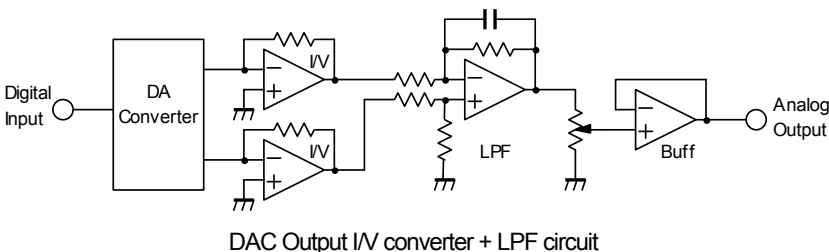

■ PACKAGE OUTLINE

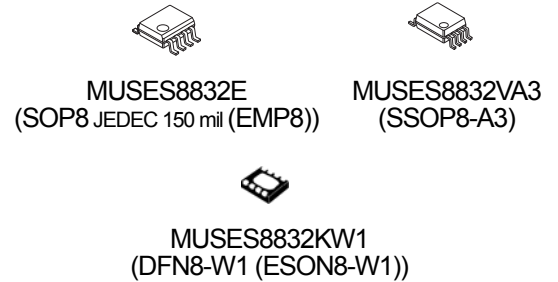

■ PIN CONFIGLATION

SOP8 JEDEC 150 mil, SSOP8-A3

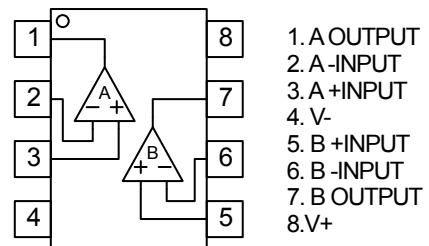

DFN8-W1 (ESON8-W1)

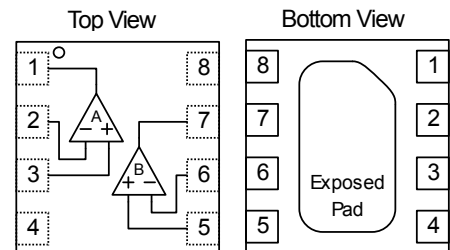

About Exposed Pad
Connect the Exposed Pad on the GND.



MUSES and this logo are trademarks of New Japan Radio Co., Ltd.

MUSES8832

■ ABSOLUTE MAXIMUM RATINGS (Ta=25°C)

PARAMETER	SYMBOL	RATING	UNIT
Supply Voltage	V^+ (V^+V)	+15 (± 7.5)	V
Input Voltage	V_{IN}	+15 ^(Note1)	V
Differential Input Voltage	V_{ID}	± 15	V
Power Dissipation	P_D	SOP8 JEDEC 150 mil: 900 SSOP8-A3: 650 ^(Note2) DFN8-W1:650 ^(Note3) :2100 ^(Note4)	mW
Operating Temperature Range	T_{opr}	-40 to +125	°C
Storage Temperature Range	T_{stg}	-65 to +150	°C

(Note1) For supply Voltages less than +15 V, the maximum input voltage is equal to the Supply Voltage.

(Note2) EIA/JEDEC STANDARD Test board (76.2 x 114.3 x 1.6mm, 2layers, FR-4) mounting.

(Note3) EIA/JEDEC STANDARD Test board (76.2 x 114.3 x 1.6mm, 2layers, FR-4) mounting. The PAD connecting to GND in the center part on the back

(Note4) EIA/JEDEC STANDARD Test board (76.2 x 114.3 x 1.6mm, 4layers, FR-4, Applying a thermal via hole to a board based on JEDEC standard JESD51-5) mounting. The PAD connecting to GND in the center part on the back

■ RECOMMENDED OPERATING CONDITION (Ta=25°C)

PARAMETER	SYMBOL	TEST CONDITION	MIN.	TYP.	MAX.	UNIT
Supply Voltage	V^+		+2.7	-	+14.0	V
	V^+V		± 1.35	-	± 7.0	V

■ ELECTRIC CHARACTERISTICS

$V^+ = +5V$, $V = 0V$, $T_a = 25^\circ C$, R_L to $V^+/2$, unless otherwise specified

PARAMETER	SYMBOL	TEST CONDITION	MIN.	TYP.	MAX.	UNIT
Supply Current	I_{CC}	No Signal, $R_L = \infty$	-	7.5	10	mA
Power Dissipation	P_D	No Signal	-	42.5	60	mW
Input Offset Voltage	V_{IO}	$R_S = 50\Omega$	-	0.1	0.5	mV
Input Bias Current	I_B		-	4	6.5	μA
Input Offset Current	I_{IO}		-	100	500	nA
Open-Loop Voltage Gain	A_V	$R_L = 10k\Omega$ to $V^+/2$, $V_O = 0.5$ to $4.5V$	90	115	-	dB
Common Mode Input Voltage Range	V_{ICM}	CMR ≥ 90 dB	0.5	-	3.7	V
Common Mode Rejection Ratio	CMR	$R_S = 50\Omega$	90	110	-	dB
Supply Voltage Rejection Ratio	SVR	$R_S = 50\Omega$	90	105	-	dB
Maximum Output Voltage 1	V_{OH1}	$R_L = 10k\Omega$ to $0V$	4.9	4.95	-	V
	V_{OL1}	$R_L = 10k\Omega$ to $0V$	-	0.05	0.1	V
Maximum Output Voltage 2	V_{OH2}	$R_L = 600\Omega$ to $V^+/2$	4.8	4.9	-	V
	V_{OL2}	$R_L = 600\Omega$ to $V^+/2$	-	0.1	0.2	V
Output Source Current	I_{SOURCE}	$V_O = V^+ - 0.5V$	10	32	-	mA
Output Sink Current	I_{SINK}	$V_O = 0.5V$	10	20	-	mA
Gain Bandwidth Product	GBW	$f = 10kHz$	-	10	-	MHz
Slew Rate	SR	$R_L = 2k\Omega$	-	1	-	V/ μs
Total Harmonic Distortion + Noise	THD+N	Gain=10, $V_O = 1.3V_{rms}$, $R_L = 2k\Omega$, $f = 1kHz$	-	0.0009	-	%
Channel Separation	CS	Gain=100, $R_S = 1k\Omega$, $R_L = 10k\Omega$, $f = 1kHz$	-	140	-	dB
Input Noise Voltage1	e_n	$f = 1kHz$	-	2.1	-	nV/ \sqrt{Hz}
Input Noise Voltage2	V_n	$f = 20Hz$ to $20kHz$	-	0.30	-	μV_{rms}

■ **NOTE**

1. The closed gain should be 6dB or higher to prevent the oscillation. Unity gain follower application may cause the oscillation.
2. Minimize the load capacitor for the better performance. A large load capacitor CL reduces the frequency response and causes oscillation or ringing.
3. Be careful to the circuit of high impedance. Input bias current influences an input noise and output offset voltage.

■ **POWER DISSIPATION vs. AMBIENT TEMPERATURE**

IC is heated by own operation and possibly gets damage when the junction power exceeds the acceptable value called Power Dissipation P_D . The dependence of the MUSES8832 P_D on ambient temperature is shown in Fig 1. The plots are depended on following two points. The first is P_D on ambient temperature 25°C, which is the maximum power dissipation. The second is 0W, which means that the IC cannot radiate any more. Conforming the maximum junction temperature T_{jmax} to the storage temperature T_{stg} derives this point. Fig.1 is drawn by connecting those points and conforming the P_D lower than 25°C to it on 25°C. The P_D is shown following formula as a function of the ambient temperature between those points.

$$\text{Dissipation Power } P_D = \frac{T_{jmax} - T_a}{\theta_{ja}} \text{ [W]} \text{ (} T_a=25^\circ\text{C to } T_a=150^\circ\text{C)}$$

Where, θ_{ja} is heat thermal resistance which depends on parameters such as package material, frame material and so on. Therefore, P_D is different in each package.

While, the actual measurement of dissipation power on MUSES8832 is obtained using following equation.

$$\text{(Actual Dissipation Power)} = (\text{Supply Current } I_{cc}) \times (\text{Supply Voltage } V^+ - V^-) - (\text{Output Power } P_o)$$

The MUSES8832 should be operated in lower than P_D of the actual dissipation power.

To sustain the steady state operation, take account of the Dissipation Power and thermal design.

Fig 1

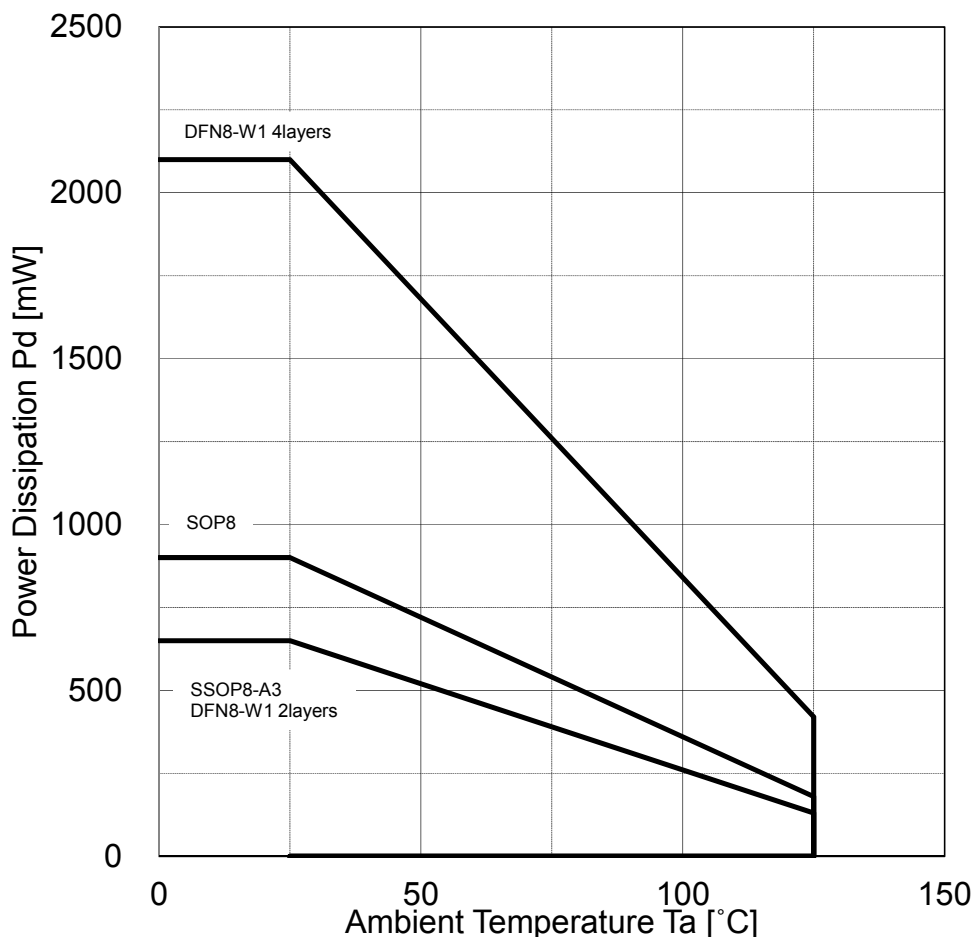

MUSES8832

■ PACKAGE OUTLINE (ESON8-W1)

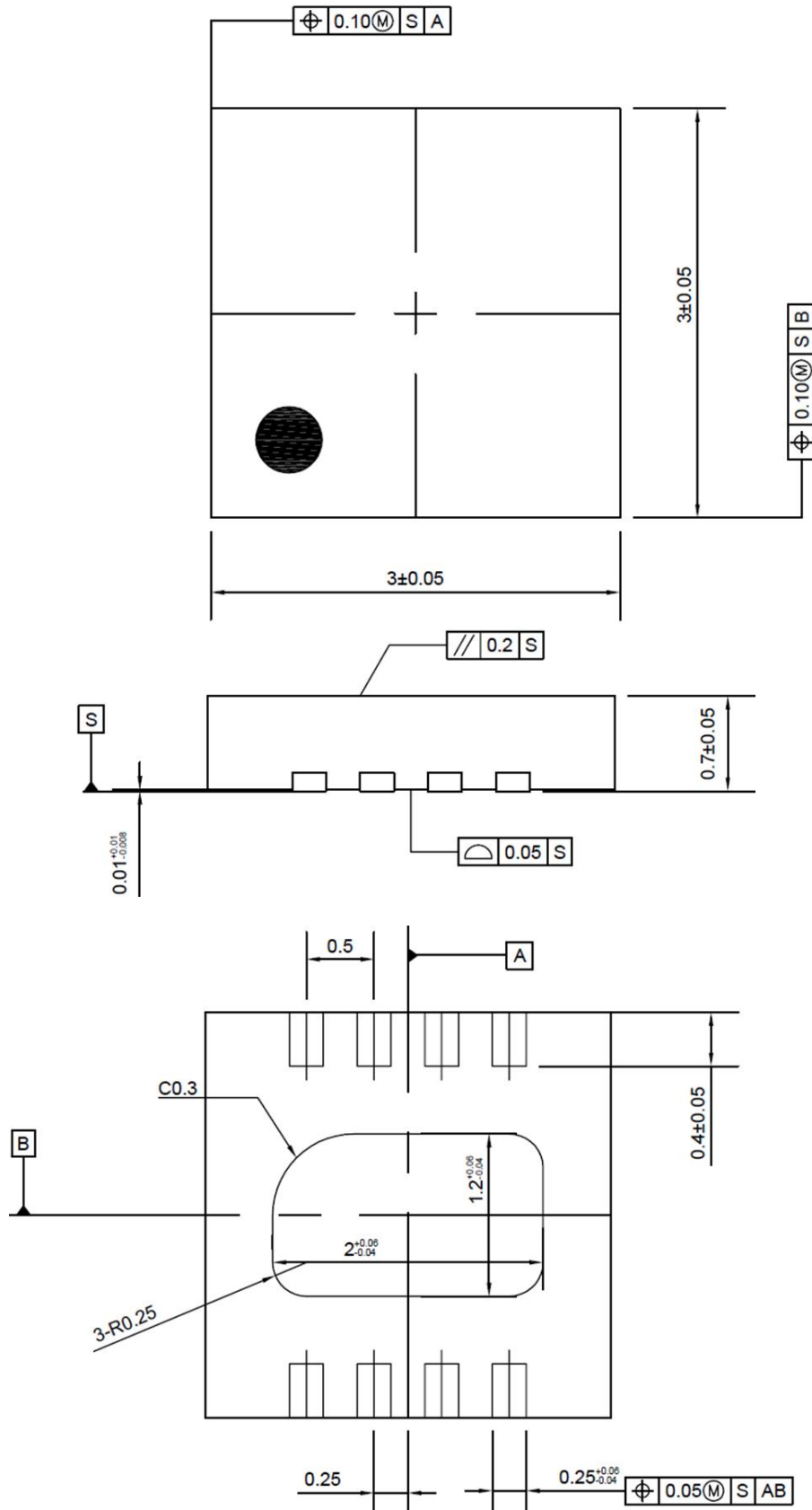

■ TYPICAL CHARACTERISTICS ($V^- = 0V$, $V_{CM} = V^+ / 2$, unless otherwise specified)

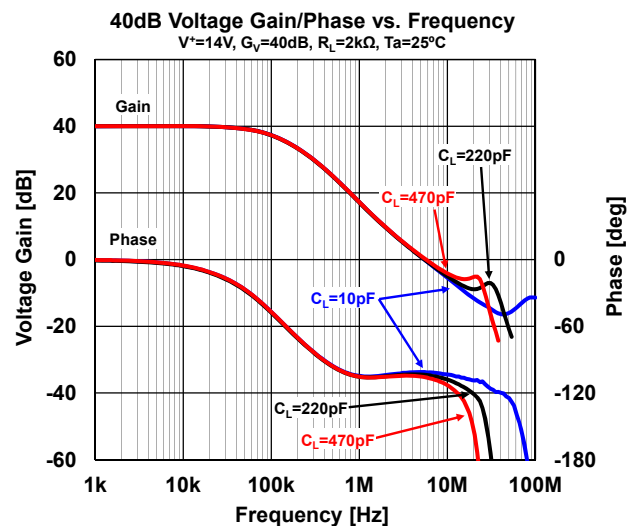
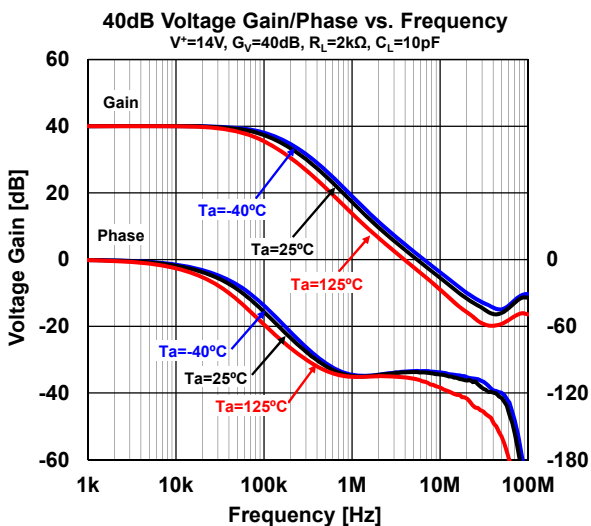
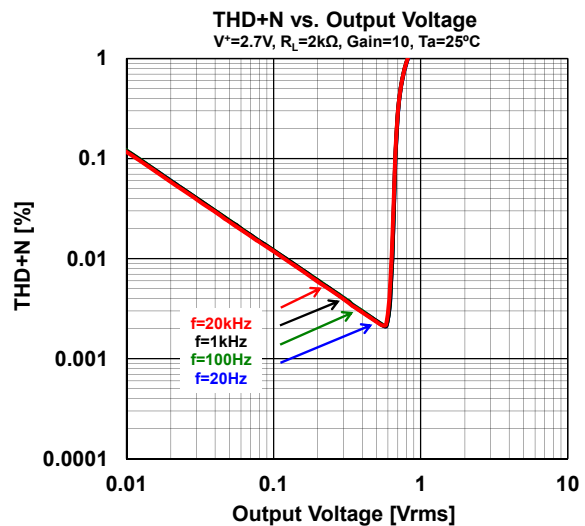
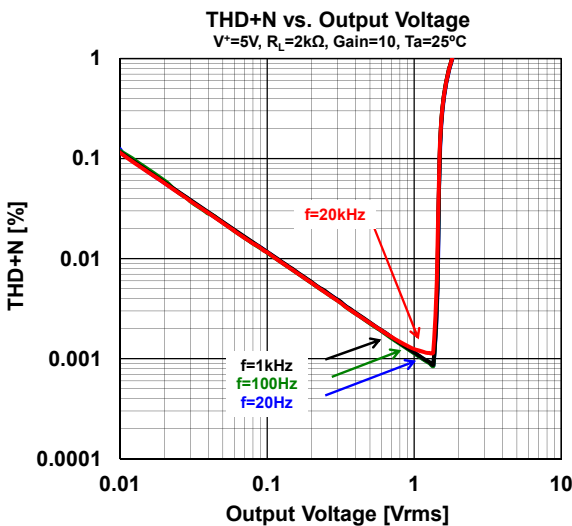
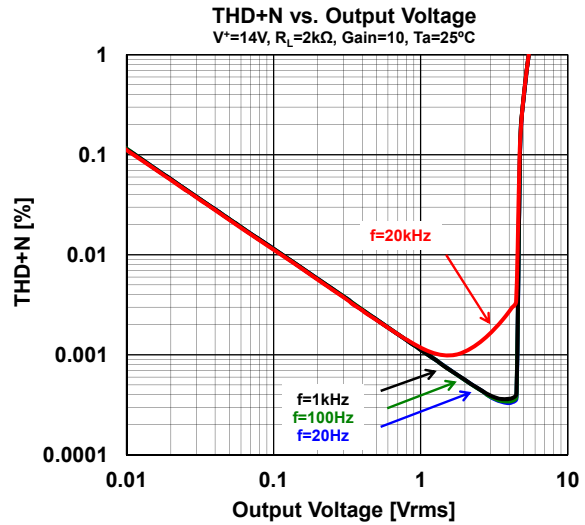
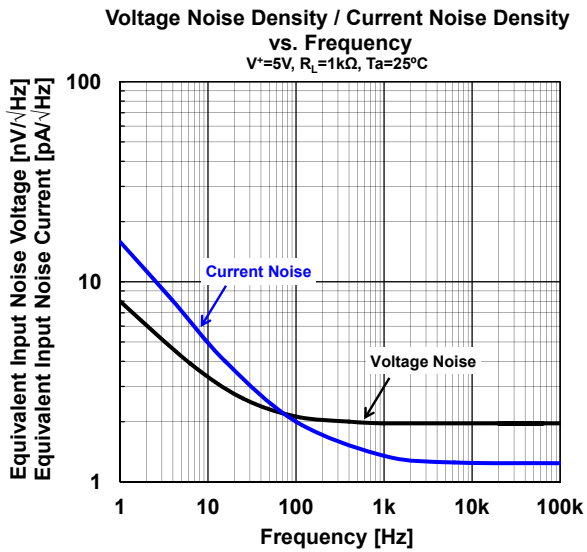

MUSES8832

■ TYPICAL CHARACTERISTICS ($V^- = 0V$, $V_{CM} = V^+ / 2$, unless otherwise specified)

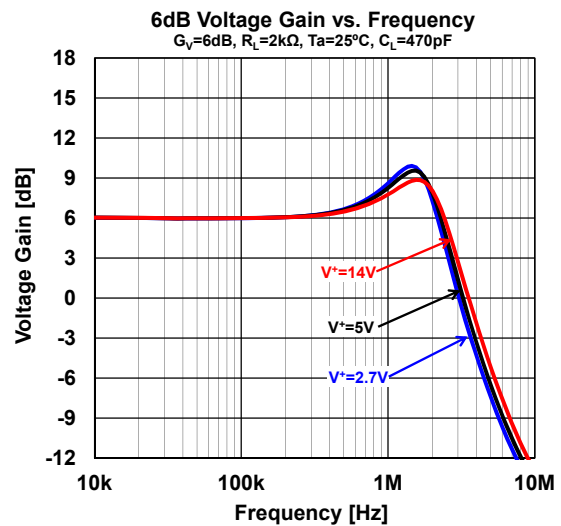
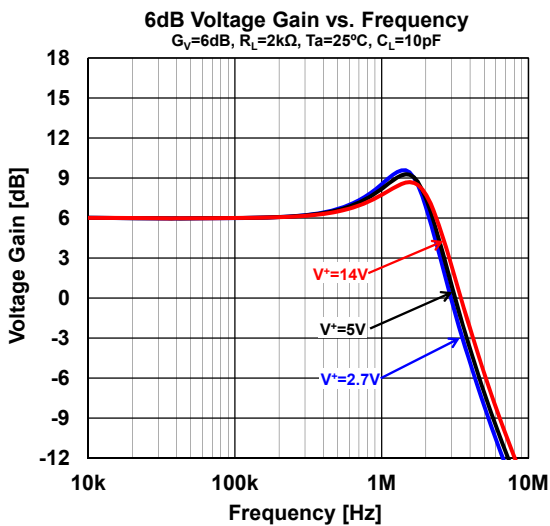
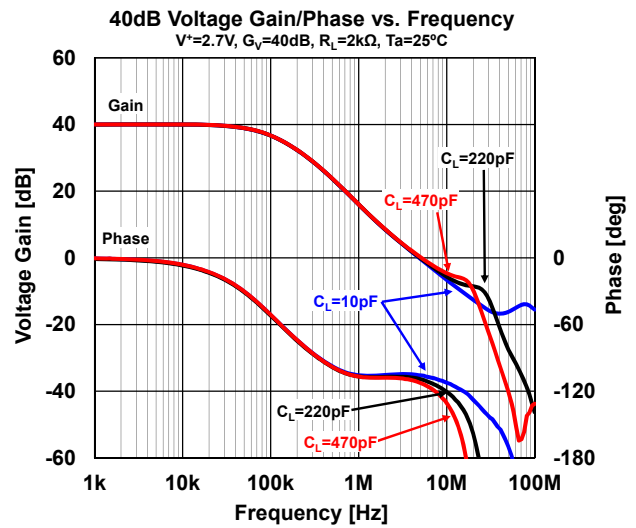
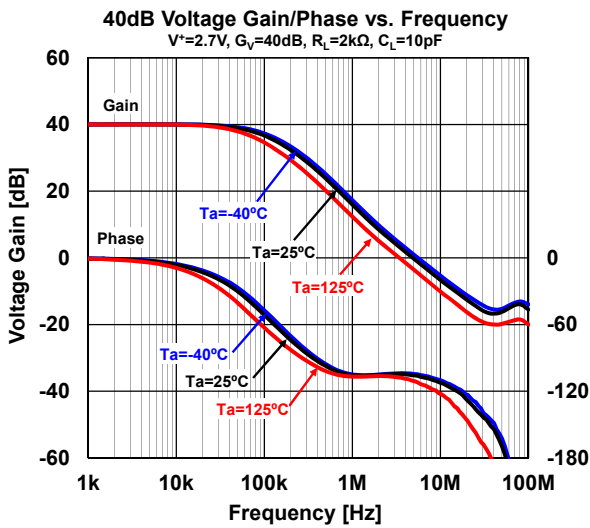
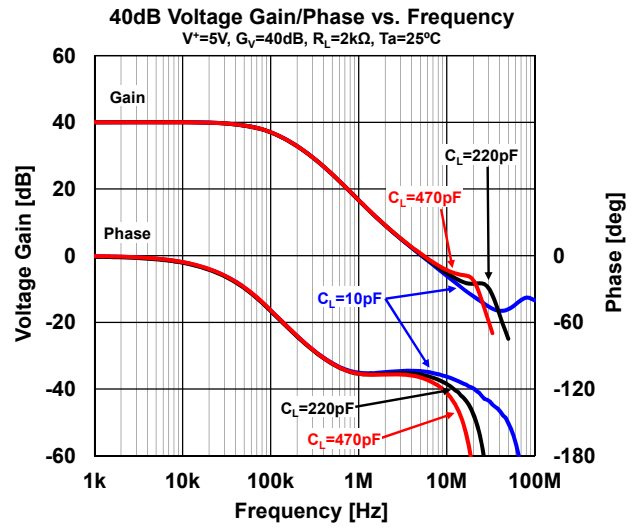
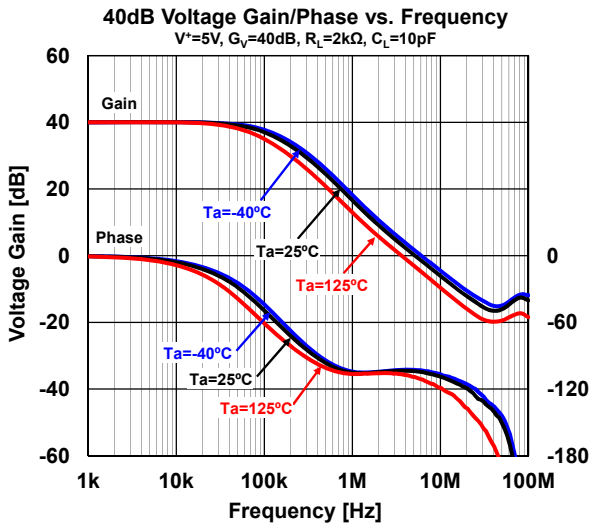

■ TYPICAL CHARACTERISTICS ($V^- = 0V$, $V_{CM} = V^+ / 2$, unless otherwise specified)

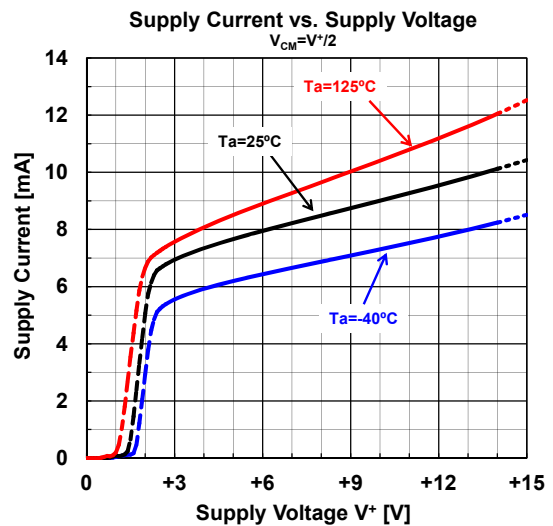
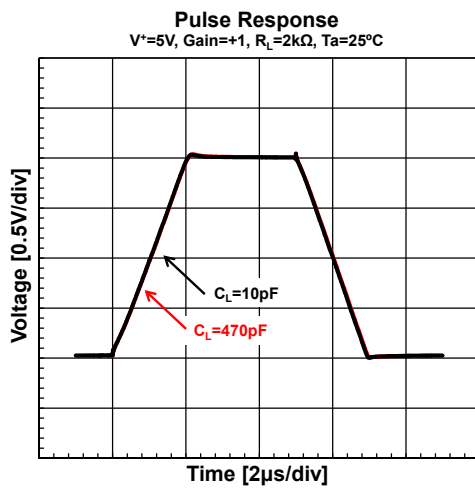
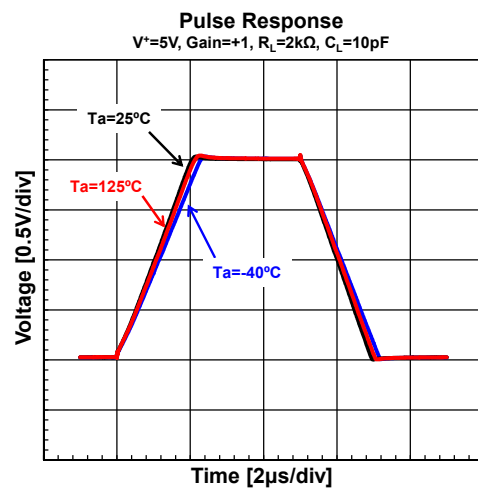
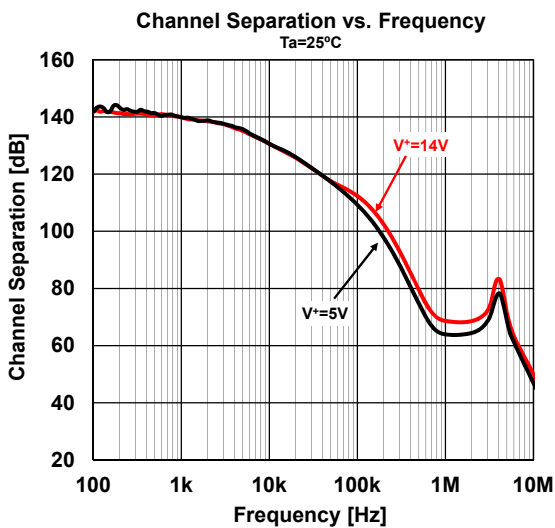
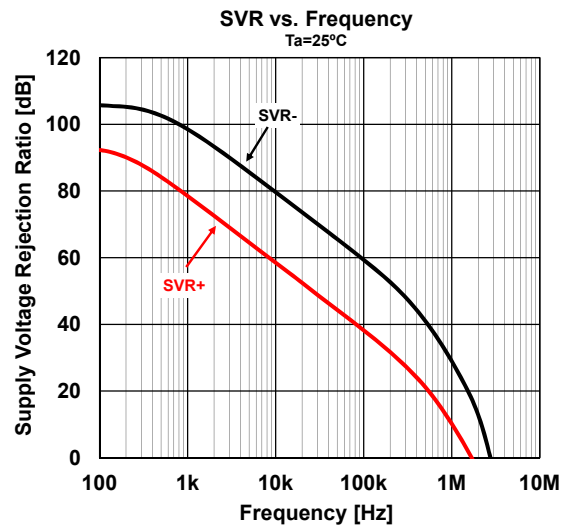
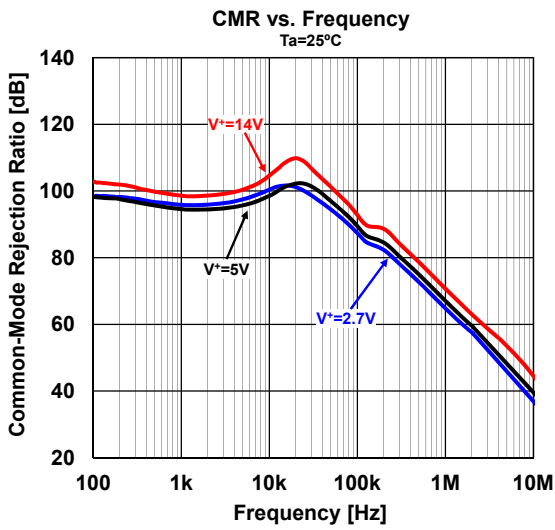

MUSES8832

■ TYPICAL CHARACTERISTICS ($V^- = 0V$, $V_{CM} = V^+ / 2$, unless otherwise specified)

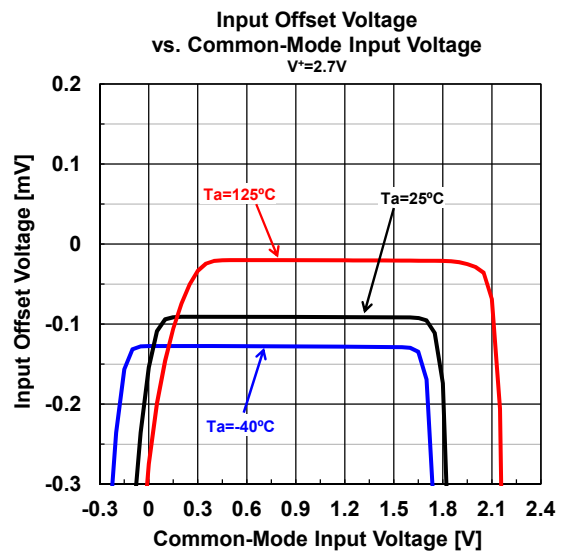
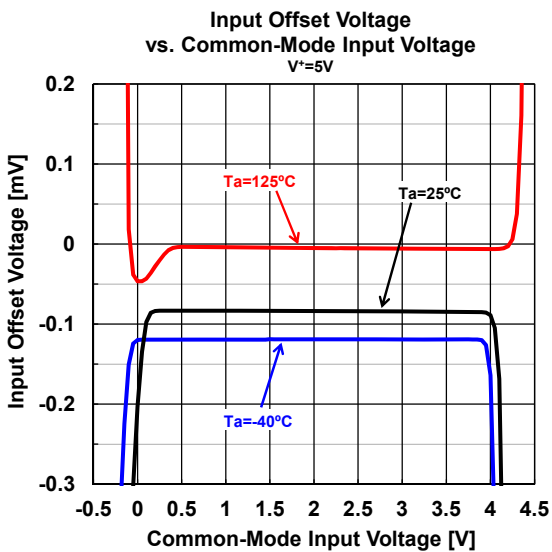
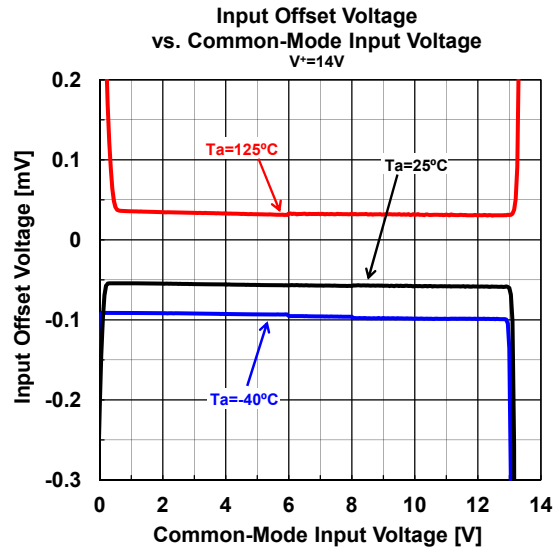
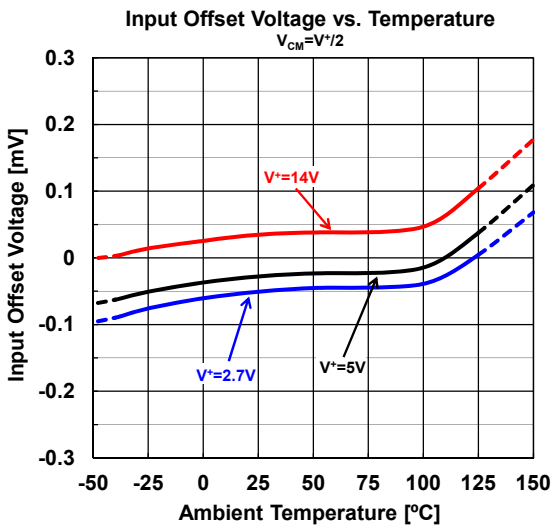
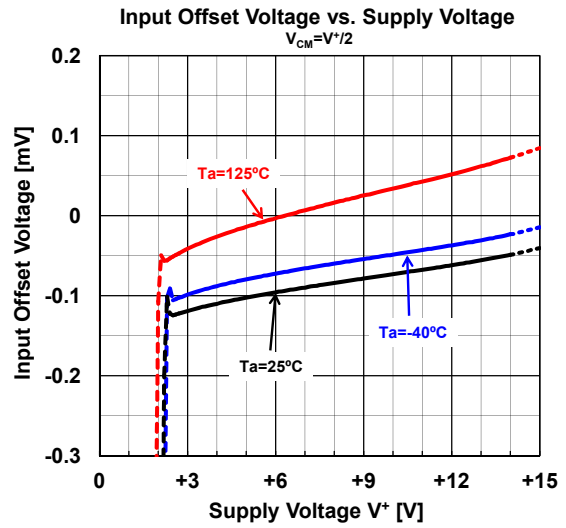
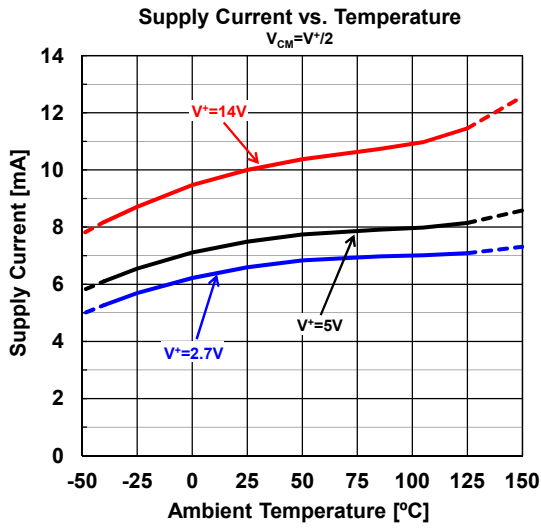

■ TYPICAL CHARACTERISTICS ($V^- = 0V$, $V_{CM} = V^+ / 2$, unless otherwise specified)

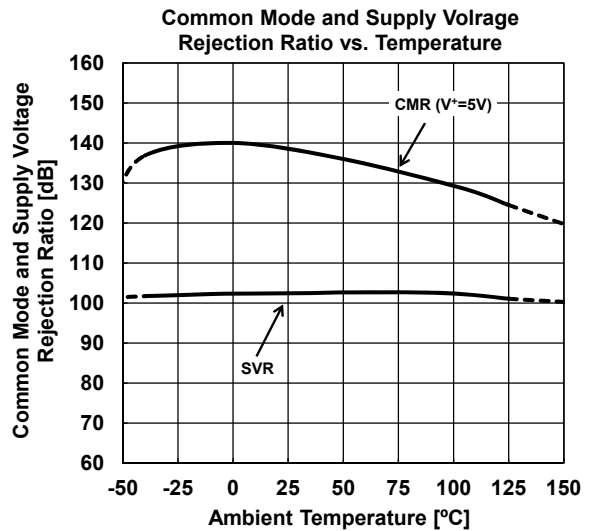
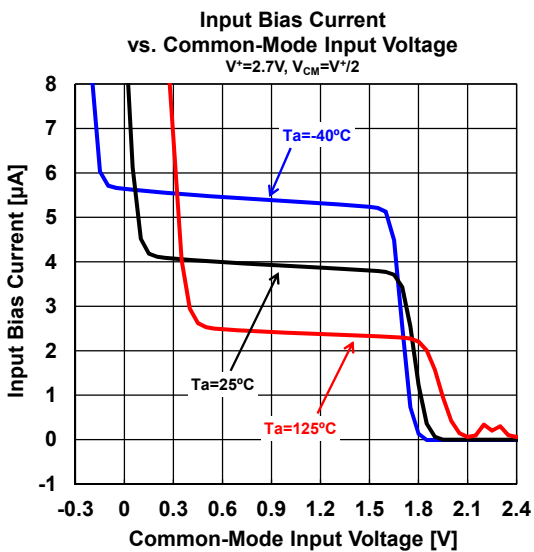
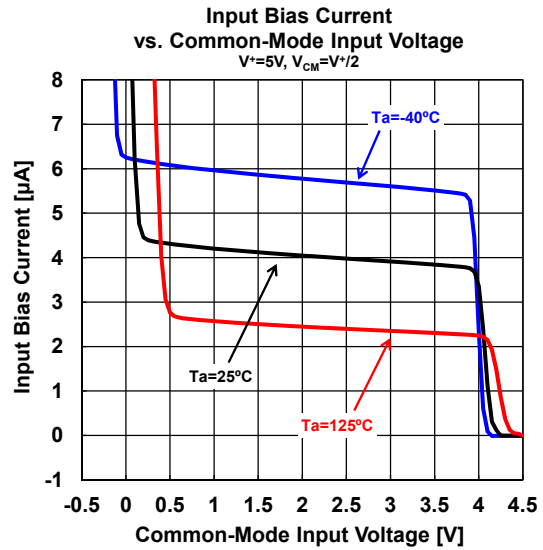
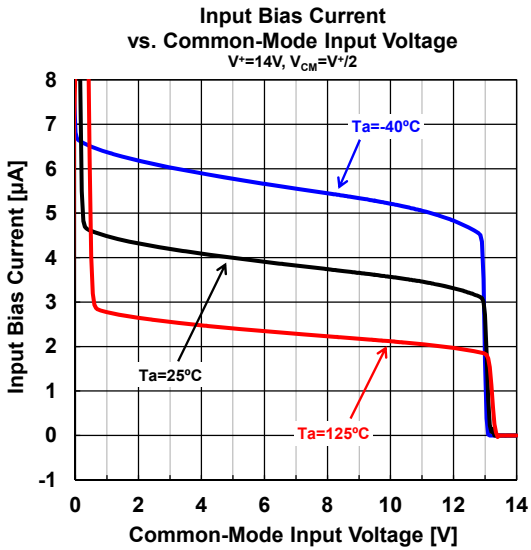
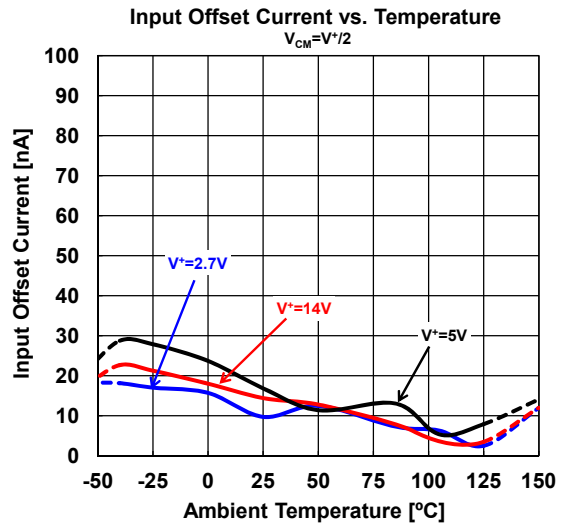
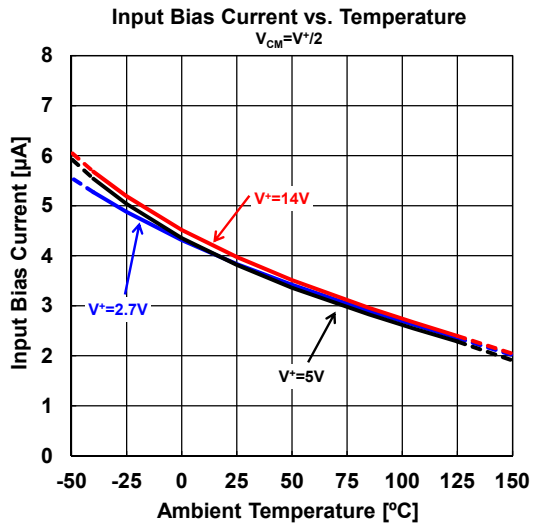

MUSES8832

■ TYPICAL CHARACTERISTICS ($V^- = 0V$, $V_{CM} = V^+ / 2$, unless otherwise specified)

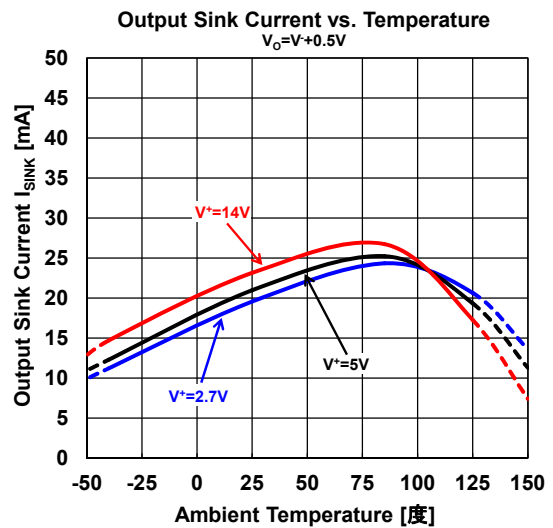
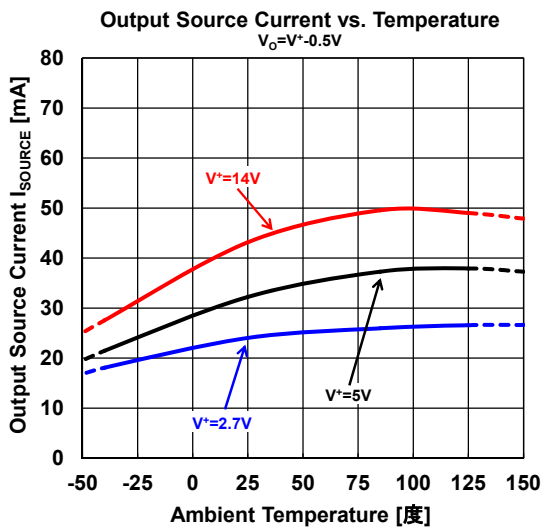
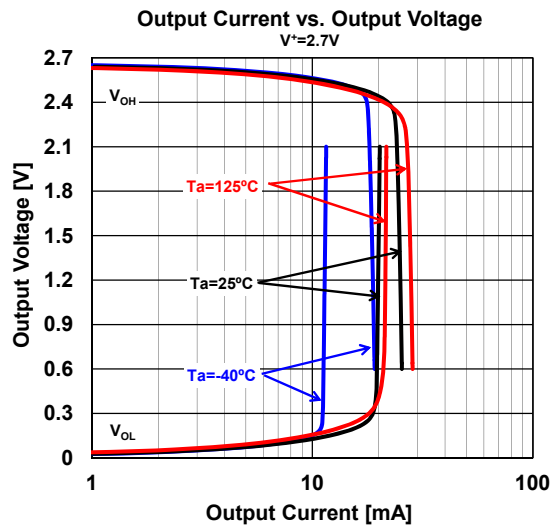
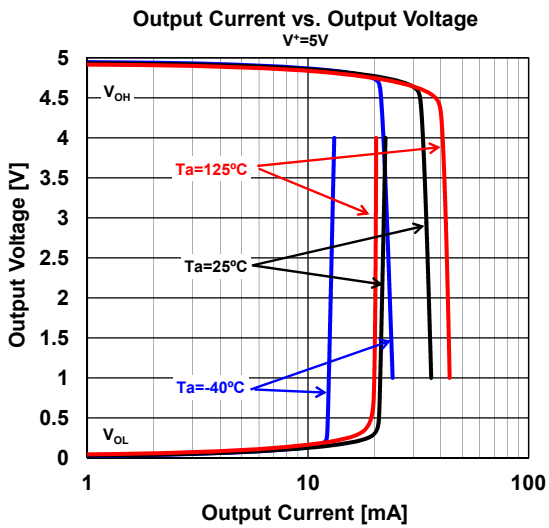
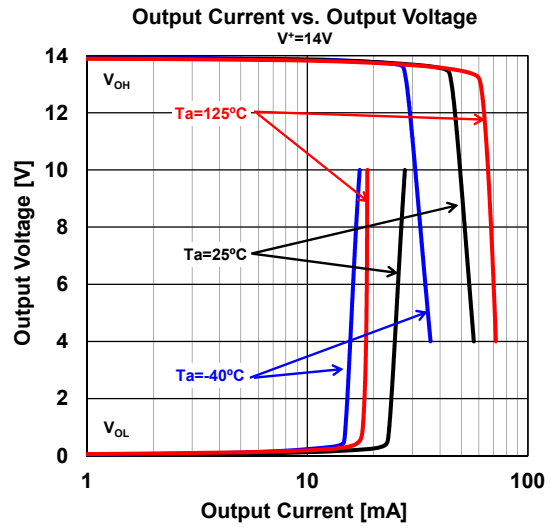
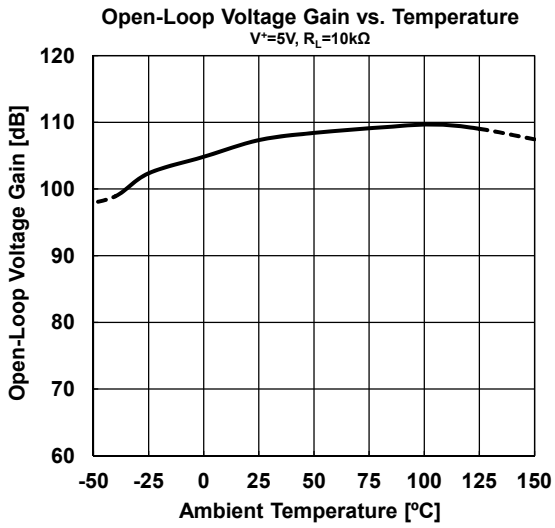

■ TYPICAL CHARACTERISTICS ($V^- = 0V$, $V_{CM} = V^+ / 2$, unless otherwise specified)

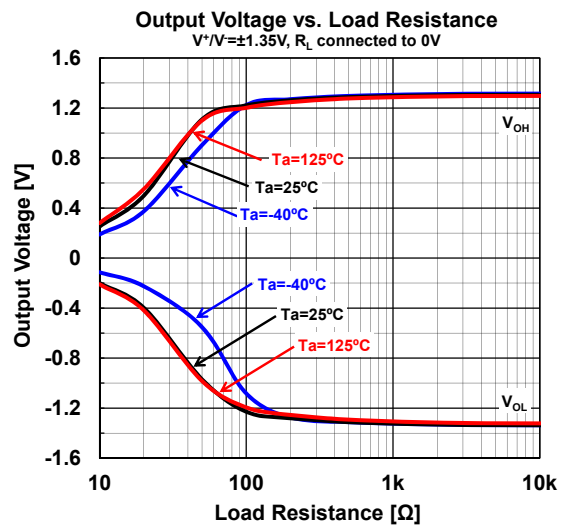
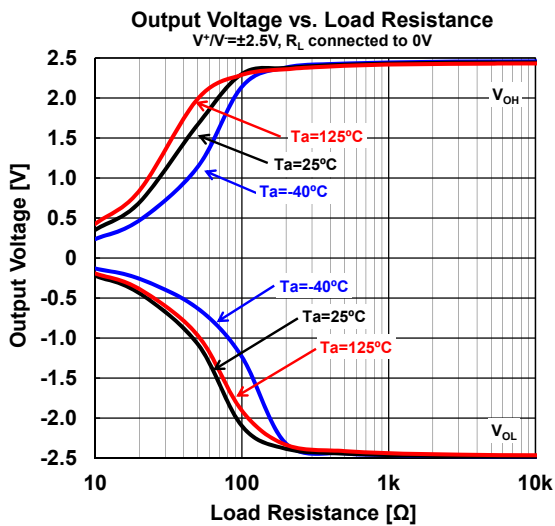
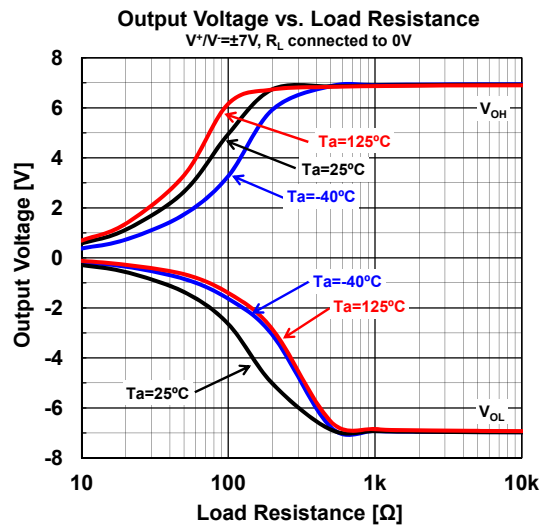
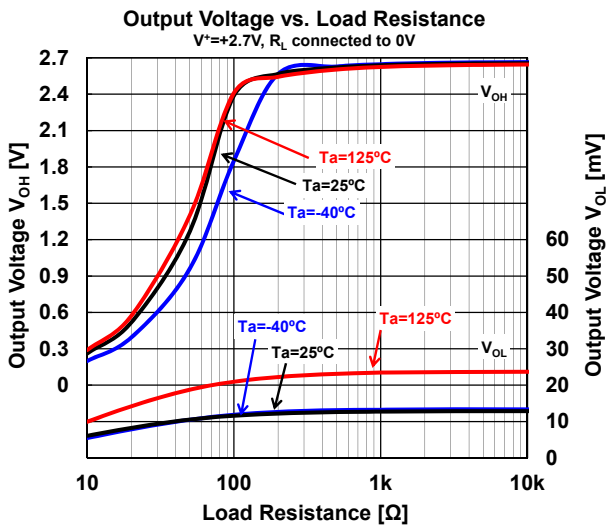
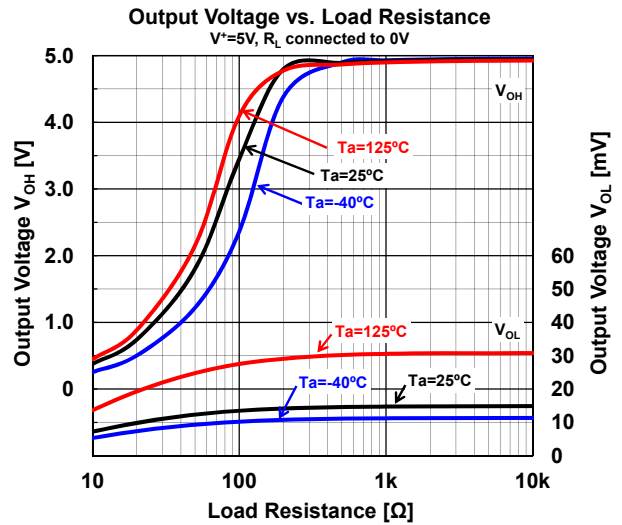
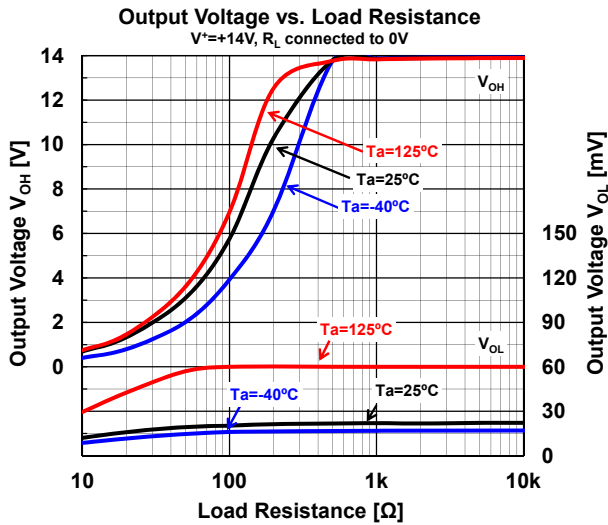

MUSES8832

APPLICATION CIRCUIT

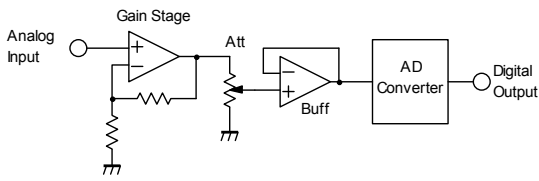

(Fig.1: ADC Input)

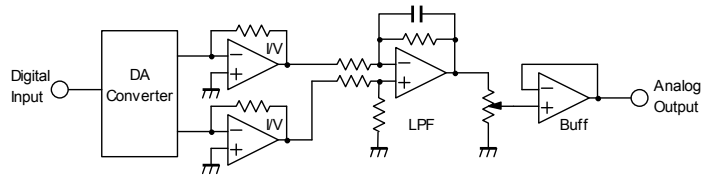

(Fig.2: DAC Output)

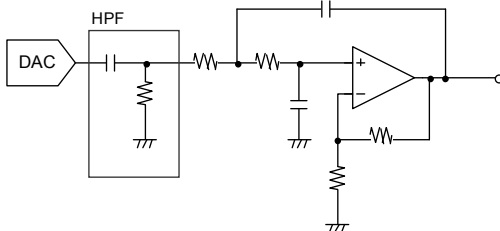

(Fig.3: DAC LPF Circuit)

NOTE

Precaution for counterfeit semiconductor products

We have recently detected many counterfeit semiconductor products that have very similar appearances to our operational amplifier "MUSES" in the world-wide market. In most cases, it is hard to distinguish them from our regular products by their appearance, and some of them have very poor quality and performance.

They can not provide equivalent quality of our regular product, and they may cause breakdowns or malfunctions if used in your systems or applications.

We would like our customers to purchase "MUSES" through our official sales channels : our sales branches, sales subsidiaries and distributors.

Please note that we hold no responsibilities for any malfunctions or damages caused by using counterfeit products. We would appreciate your understanding.

[CAUTION]
The specifications on this databook are only given for information, without any guarantee as regards either mistakes or omissions. The application circuits in this databook are described only to show representative usages of the product and not intended for the guarantee or permission of any right including the industrial rights.